

SOCU2300MX

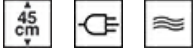

Category 24" compact
Product Family Oven
Power supply Electric
Cooking method Microwave with grill
EAN code 8017709341855



Aesthetics

Aesthetic	Classica	Serigraphy colour	Black
Colour	Stainless steel	Serigraphy type	Symbols
Finishing	Fingerproof	Handle	Classic
Design	Flat	Handle Colour	Inox
Material	Stainless steel	Logo	Embossed
Type of steel	Brushed		

Controls



Display name	DigiScreen	Control setting	Knobs
Display technology	LED	No. of controls	2

Programs / Functions

No. of cooking functions 3
Traditional cooking functions



Large grill

Microwave functions



Microwave



Microwave + grill

Options

Time-setting options	Automatic end cooking	Timer	1
Minute minder	Yes		

Technical Features

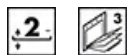

Capacity (Lt)		Grill element - power	1200 W
No. of shelves	2	Total no. of door glasses	3
No. of lights	1	Microwave stops when door is opened	Yes
Light Power	20 W	Cooling duct	Single
Light when door is opened	Yes	Cavity material	Stainless steel
Turntable	Yes	Microwave screen protection	Yes
Turntable dimension	12 5/8 "		

Performance / Energy Label

Microwave effective power	1000 W
----------------------------------	--------

Accessories Included

Rack	2
-------------	---

Electrical Connection

Voltage	240 V	Voltage 2	120/208 V
Plug	No	Frequency (Hz)	60 Hz
Current	14,2 A	Power supply cable length	59 1/16 "
Nominal power	3400 W		

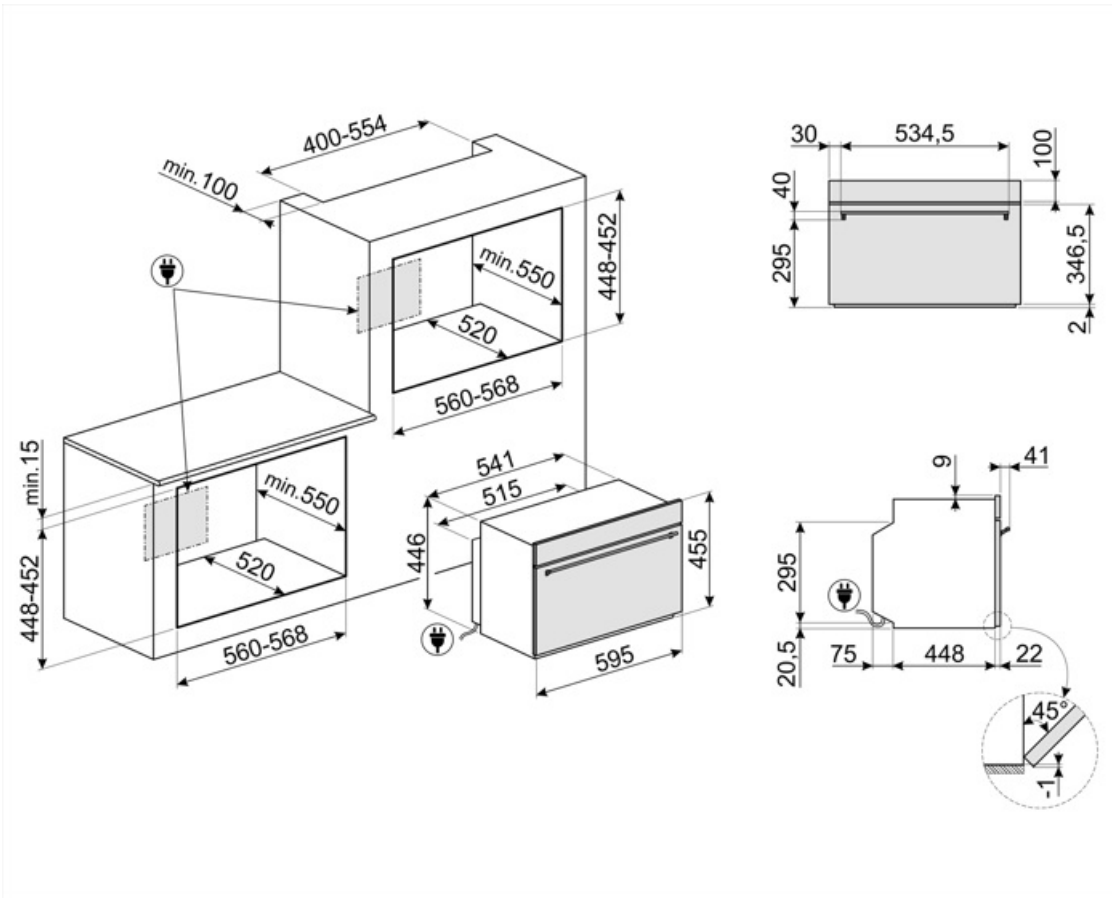

Compatible Accessories

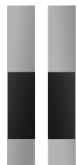











KIT4300MX



STONE2

Rectangular pizza stone without handles, suitable for 45cm and 60cm wide ovens. Dimensions W42 x H1.8 x D37.5cm. Ideal for cooking pizzas with the same results as a typical wood-fired oven. Can also be used for baking bread, focaccias and other recipes such as pies, flans or biscuits

Symbols glossary

	Microwave energy shortens cooking times dramatically and produces energy savings.		4.3 inch display with LED technology, usability with knobs + 3 touch keys
	Triple glazed doors: Number of glazed doors.		Electric
	Ever Clean Enamel: Ever Clean enamel is applied electrostatically, corner to corner and edge to edge to prevent cracking or cracks over time. It is a particular pyrolytic enamel, resistant to acids which, in addition to being pleasantly bright, promotes greater cleaning of the oven walls, thanks to its lower porosity. It is baked at over 850 ° C and slowly polymerized at a scientifically determined rate to ensure uniform depth and strength Ever Clean enamel creates an impeccable finish both on the inside of the oven and on the trays, making the surfaces of the oven incredibly easy to maintain over time as it reduces the adhesion of fat during cooking		Grill: Very intense heat coming only from above from a double heating element. The fan is not active. Provides excellent grilling and gratinating results. Used at the end of cooking, it gives a uniform browning to dishes.
	Microwave + grill element: The use of the grill results in a perfect browning of the surface of the food. The action of microwaves allows instead of cooking in a short time the internal part of the food.		Microwave: Penetrating straight into the food, microwaves cook very quickly and with considerable energy savings. Suitable for cooking without fat, they are also able to thaw and heat food without altering its original appearance and aroma. The microwave function can also be combined with conventional functions with all the resulting advantages. Ideal for all types of food.
	Compact appliances with a height of 45 cm - perfect solution to meet the functional requirements of kitchen sets of small height. Available in several types and in different styles.		The oven cavity has 2 different cooking levels.
	The capacity indicates the amount of usable space in the oven cavity in litres.		