

# SOP6102TN



Category	60cm
Product Family	Oven
Power supply	Electric
Heat source	Electric
Cooking method	Thermo-ventilated
Galileo cavity	Traditional pyro
Cleaning system	Pyrolytic
EAN code	8017709301682



## Aesthetics

Aesthetics	Linea	Serigraphy colour	Grey
Colour	Black	Serigraphy type	Symbols
Finishing	Gloss	Door	Full glass
Design	Flat	Handle	Linea
Material	Glass	Handle Colour	Chromed
Glass Type	Clear1	Logo	Silk screen

## Controls













Display name	EvoScreen	No. of controls	2
Display technology	LCD	Control knobs	Linea
Control setting	Knobs & touch buttons		

## Programs / Functions

No. of cooking functions	10
--------------------------	----

## Traditional cooking functions

 Static	 Fan assisted	 Circulaire
 Turbo (circulaire + bottom + upper + fan)	 ECO	 Large grill
 Fan grill (large)	 Base	 Circulaire + bottom
 Pizza		

## Other functions

 Defrost by time	 Proving	 Stone cooking
 BBQ	 Air-Fry	 Sabbath

## Cleaning functions

 Pyrolytic
--

## Options



<b>Time-setting options</b>	Delay start and automatic end cooking	<b>Other options</b>	Keep warm, Eco light, Tones, Brightness
<b>Minute minder</b>	Yes	<b>Showroom demo option</b>	Yes
<b>Timer</b>	1	<b>Rapid pre-heating</b>	Yes
<b>Controls Lock / Child Safety</b>	Yes		

## Technical Features



<b>Minimum Temperature</b>	30 °C	<b>Removable door</b>	Yes
<b>Maximum temperature</b>	280 °C	<b>Full glass inner door</b>	Yes
<b>Shelf positions</b>	5	<b>Removable inner door</b>	Yes
<b>Shelves type</b>	Metal racks	<b>Total no. of door glasses</b>	4
<b>No. of lights</b>	2	<b>Soft Close hinges</b>	Yes
<b>Light type</b>	Halogen	<b>Soft Open</b>	Yes

<b>User-replaceable light</b>	Yes	<b>Safety Thermostat</b>	Yes
<b>Light power</b>	40 W	<b>Chimney</b>	Fixed
<b>Light when door is opened</b>	Yes	<b>Cooling system</b>	Tangential
<b>Lower heating element power</b>	1200 W	<b>Cooling duct</b>	Double
<b>Grill element - power</b>	1750 W	<b>Speed Reduction Cooling System</b>	Yes
<b>Circular heating element - Power</b>	2000 W	<b>Door Lock During Pyrolysis</b>	Yes
<b>Heating suspended when door is opened</b>	Yes	<b>Usable cavity space dimensions (HxWxD)</b>	353x470x401 mm
<b>Door opening type</b>	Standard opening	<b>Temperature control</b>	Electronic
<b>Door</b>	Cool	<b>Cavity material</b>	Easy clean enamel

## Performance / Energy Label



<b>Energy efficiency class</b>	A+	<b>Energy consumption in forced air convection</b>	2.45 MJ
<b>Net volume of the cavity</b>	68 litres	<b>Energy consumption per cycle in fan-forced convection</b>	0.68 kWh
<b>Energy consumption per cycle in conventional mode</b>	1.09 kWh	<b>Number of cavities</b>	1
<b>Energy consumption in conventional mode</b>	3.92 MJ	<b>Energy efficiency index</b>	81 %

## Accessories Included



<b>Chrome shelf</b>	1	<b>Grill mesh</b>	1
<b>Enamelled tray (20mm)</b>	1	<b>Telescopic Guide rails, partial Extraction</b>	1
<b>Enamelled deep tray (50mm)</b>	1		

## Electrical Connection

<b>Voltage</b>	220-240 V	<b>Frequency (Hz)</b>	50/60 Hz
<b>Current</b>	13 A	<b>Power supply cable length</b>	115 cm
<b>Nominal power (W)</b>	3000 W		

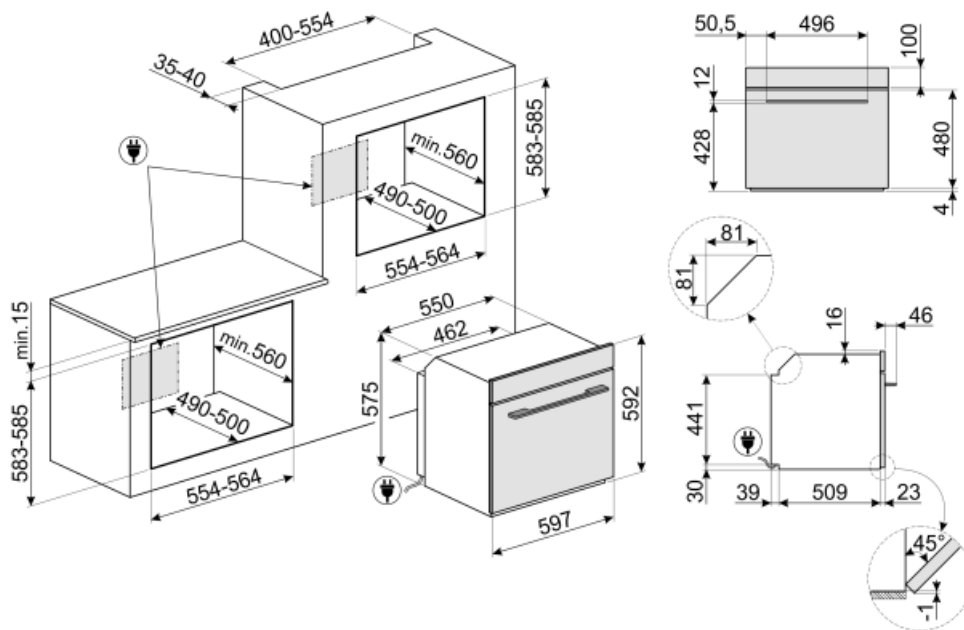

## Not included accessories

### AIRFRY

Air fryer rack AIRFRY . Ideal for recreating traditional frying in the oven, but with fewer calories and less fat. It allows you to cook quickly and simply dishes such as French fries, fried vegetables and fish, ensuring perfect browning and crispiness.



### SFLK1

Child lock



### ET50

Enamelled tray, 50mm deep



### ET20

Enamelled tray, 20mm deep



### STONE

Rectangular refractory stone. Ideal for cooking pizzas with the same results as a typical wood-fired oven. Can also be used for baking bread, focaccias and other recipes such as pies, flans or biscuits Dimensions:L42 x H1,8 x P37,5 cm.



### GTP2

Partially extractable telescopic guides (1 level), suitable for traditional ovens. Made in stainless steel, they guarantee stability and facilitate the smooth extraction of the trays.



### PR3845X

Antifingerprint stainless steel. Cover for furniture in column installation of more ovens



### GTT2

Totally extractable telescopic guides (1 level), suitable for traditional ovens. Made in stainless steel, they guarantee stability and facilitate the smooth extraction of the trays.



### BBQ

Double sided plate BBQ. Suitable for recreating succulent and crispy dishes in the oven with the typical taste of grilled cooking. The ribbed side is particularly suitable for meats and cheeses. The smooth side for fish, seafood and vegetables.







































### PALPZ

Pizza shovel with fold away handle width: 315mm length : 325mm



## Symbols glossary

 <p>A+: Energy efficiency class A+ helps to save up to 10% energy compared to class A. Maximum performance with minimum consumption is guaranteed.</p>	 <p>Child lock: some models are fitted with a device to lock the programme/cycle so it cannot be accidentally changed.</p>
 <p>Air cooling system: to ensure a safe surface temperatures.</p>	 <p>Defrost by time: with this function the time of thawing of foods are determined automatically.</p>
 <p>Quadruple glazed: Number of glazed doors.</p>	 <p>Automatic lighting switches off: for greater energy savings, the lighting switches off automatically after one minute from the start of cooking.</p>
 <p>Electric</p>	 <p>Enamel interior: The enamel interior of all Smeg ovens have a special antacid lining which helps keep the interior clean by reducing the amount of cooking grease adhering to it.</p>
 <p>Fresh Touch: Most of Smeg ovens have a "cool door." Thanks to the combination of tangential cooling and internal heat-reflecting glasses, the temperature on the outer surface of the door is maintained below 50° C. In addition to providing safety, this system protects the sides of the furniture from overheating by the oven.</p>	 <p>Fan with upper and lower elements: The elements combined with the fan aim to provide more uniform heat, a similar method to conventional cooking, so pre-heat is required. Most suitable for items requiring slow cooking methods.</p>
 <p>Upper and lower element only: a traditional cooking method best suited for single items located in the centre of the oven. the top pf the oven will always be hottest. Ideal for roast, fruit cakes, bread etc.</p>	 <p>Lower heating element only: This function is ideal for foods that require extra base temperature without browning, e.g. pastry dishes, pizza. Also suitable for slow cooking of stews and casseroles.</p>
 <p>Circulaire with lower element: The addition of the lower element adds extra heat at the base for food which requires extra cooking.</p>	 <p>Circulaire: The combination of the fan and circular element around it gives a hot air cooking method. This provides many benefits including no preheat if cook time is more than 20 minutes, no flavour transfer when cooking different foods at the same time, less energy, and shorter cook times. Good for all types of food.</p>
 <p>ECO: The combination of the grill, fan and lower element is particularly suitable for cooking small quantities of food.</p>	 <p>Grill element: Using of grill gives excellent results when cooking meat of medium and small portions, especially when combined with a rotisserie (where possible). Also ideal for cooking sausages and bacon.</p>
 <p>Fan with grill element: The fan reduces the fierce heat from the grill, providing an excellent method of grilling various foods, chops, steaks, sausages etc. giving even browning and heat distribution, without drying out the food. The top two levels recommended for use, and the lower part of the oven can be used to keep items warm at the same time, an excellent facility when cooking a grilled breakfast. Half grill (centre portion only) is ideal for small quantities of food.</p>	 <p>Pizza function: The simultaneous operation of three elements ensures an optimum cooking facility when used with the Smeg pizza stone.</p>

- |   |  |
|---|--|
|  <p><b>Circulaire with upper and lower elements:</b> The use of the fan with both elements allows food to be cooked quickly and effectively, ideal for large joints that require thorough cooking. It offers a similar result to rotisserie, moving the heat around the food, instead of moving the food itself, enabling any size or shape to be cooked.</p> |  <p><b>All glass inner door:</b> All glass inner door, a single flat surface which is simple to keep clean.</p>   |
|  <p><b>The inner door glass:</b> can be removed with a few quick movements for cleaning.</p>  |  <p><b>Keep warm:</b> This function allows you to keep precooked foods warm.</p>  |
|  <p><b>Side lights:</b> Two opposing side lights increase visibility inside the oven.</p>   |  <p><b>Pyrolitic:</b> Pyrolitic cleaning cycles can be selected as necessary to automatically clean the oven interior.</p>  |
|  <p><b>Air at 40°C</b> provides the perfect environment for proving yeast type dough mixes. Simply select the function and place dough in the cavity for allotted</p>   |  <p><b>Rapid preheat:</b> The rapid preheat function can be used to reach the selected temperature in just a few minutes.</p>   |
|  <p><b>Sabbath:</b> This function allows you to cook food during the Sabbath, the Holiday of rest in the Jewish religion, respecting the precepts. The oven works</p>   |  <p>The oven cavity has 5 different cooking levels.</p>   |
|  <p><b>Soft close:</b> all models are equipped with advanced function of smooth closing of the door, which allows the device to close smoothly and quietly.</p>   |  <p><b>Telescopic rails:</b> allow you to pull out the dish and check it without having to remove it from the oven entirely.</p>                                      |
|  <p><b>Electronic control:</b> Allows you to maintain temperature inside the oven with the precision 2-3 ° C. This enables to cook meals that are very sensitive to temperature changes, such as cakes, souffles, puddings.</p>   |  <p>The capacity indicates the amount of usable space in the oven cavity in litres.</p>   |
|  <p>...</p>   |  <p><b>Dedicated cooking function for the double sided plate BBQ.</b> Suitable for recreating succulent and crispy dishes in the oven with the typical taste of g</p> |
|  <p><b>Dedicated cooking function for the Air fryer rack AIRFRY .</b> Ideal for recreating traditional frying in the oven, but with fewer calories and less fat.</p>  |  <p><b>Dedicated cooking function for the rectangular refractory stone PPR2</b> Dimensions Ideal for cooking pizzas with the same results as a typical wood-fire</p>  |