

# SOP6900TN



Category	60 cm
Product Family	Oven
Power supply	Electric
Heat source	ELECTRICITY
Cooking method	Thermo-ventilated
Galileo platform	Traditional pyro
Cleaning system	Pyrolitic
EAN code	8017709314903



## Aesthetics

Aesthetic	Victoria	Door	With panel
Colour	Black	Handle	Victoria
Design	Rounded	Handle Colour	Inox
Material	Painted material	Logo	Applied
Glass Type	Clear	Control knobs	Victoria
Serigraphy colour	White	Controls colour	Steel effect
Serigraphy type	Symbols		

## Controls



Display name	DigiScreen	Control setting	Knobs
Display technology	LED	No. of controls	2

## Programs / Functions main oven

No. of cooking functions 9  
Traditional cooking functions

Static	Fan assisted	Circulaire
Turbo	Eco	Large grill
Fan grill (large)	Base	Fan assisted base

## Cleaning functions

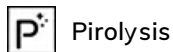

## Options



<b>Time-setting options</b>	Delay start and automatic end cooking
<b>Minute minder</b>	Yes
<b>Timer</b>	1

<b>Other options</b>	Keep warm, Eco light
<b>Showroom demo option</b>	Yes
<b>Rapid pre-heating</b>	Yes

## Technical Features



<b>Capacity (Lt)</b>	68 l
<b>Cavity</b>	QS-Galileo
<b>Minimum Temperature</b>	30 °C
<b>Maximum temperature</b>	260 °C
<b>No. of shelves</b>	5
<b>N. of fans</b>	1
<b>No. of lights</b>	2
<b>Light type</b>	Halogen
<b>User-replaceable light</b>	Yes
<b>Light Power</b>	40 W
<b>Light when door is opened</b>	Yes
<b>Lower heating element power</b>	1200 W
<b>Upper heating element - Power</b>	1000 W
<b>Grill element - power</b>	1700 W
<b>Large grill - Power</b>	2700 W

<b>Circular heating element - Power</b>	2000 W
<b>Heating suspended when door is opened</b>	Yes
<b>Door opening type</b>	Standard opening
<b>Door</b>	Cool
<b>Removable door</b>	Yes
<b>Full glass inner door</b>	Yes
<b>Removable inner door</b>	Yes
<b>Total no. of door glasses</b>	4
<b>Chimney</b>	Fixed
<b>Cooling system</b>	Tangential
<b>Cooling duct</b>	Double
<b>Door Lock During Pyrolysis</b>	Yes
<b>Usable cavity space dimensions (HxWxD)</b>	353x470x401 mm
<b>Temperature control</b>	Electronic
<b>Cavity material</b>	Ever clean Enamel

## Performance / Energy Label



<b>Energy efficiency class</b>	A
<b>Net volume of the cavity</b>	68 l
<b>Energy consumption per cycle in conventional mode</b>	1,09 kWh
<b>Energy consumption in conventional mode</b>	3,92 MJ

<b>Energy consumption in forced air convection</b>	2,88 MJ
<b>Energy consumption per cycle in fan-forced convection</b>	0,80 kWh
<b>Number of cavities</b>	1
<b>Energy efficiency index</b>	95,2 %

## Accessories included



## Compatible Accessories

### AIRFRY

Air fryer rack AIRFRY. Ideal for recreating traditional frying in the oven, but with fewer calories and less fat. It allows you to cook quickly and simply dishes such as French fries, fried vegetables and fish, ensuring perfect browning and crispiness.



### BBQ

Double sided plate BBQ. Suitable for recreating succulent and crispy dishes in the oven with the typical taste of grilled cooking. The ribbed side is particularly suitable for meats and cheeses. The smooth side for fish, seafood and vegetables.



### ET50

Enamelled tray suitable for 45 cm and 60 cm ovens. Depth 50 mm. Perfect for cooking and roasting meat and fish in sauces. Also ideal for experimenting with lighter and crunchy side dishes



### GTT2

Totally extractable telescopic guides (1 level), suitable for traditional ovens. Made in stainless steel, they guarantee stability and facilitate the smooth extraction of the trays.



### PR3845X

Antifingerprint stainless steel. Cover for furniture in column installation of more ovens



### AIRFRY2

Air fryer tray. Ideal for recreating traditional frying in the oven, but with fewer calories and less fat. It allows you to cook quickly and simply dishes such as French fries, fried vegetables and fish, ensuring perfect browning and crispiness.



### ET20

Enamelled tray suitable for 45 cm and 60 cm ovens. Depth 20 mm. Perfect for a wide range of savoury and sweet baking.



### GTP2

Partially extractable telescopic guides (1 level), suitable for traditional ovens. Made in stainless steel, they guarantee stability and facilitate the smooth extraction of the trays.



### PALPZ

Pizza shovel with folding handle. Dimensions L31.5 x H32.5 cm. Easy and convenient to use and store. Perfect for serving pizza, bread and savory pastries in a safe and professional way.



### STONE2

Rectangular pizza stone without handles, suitable for 45cm and 60cm wide ovens. Dimensions W42 x H1.8 x D37.5cm. Ideal for cooking pizzas with the same results as a typical wood-fired oven. Can also be used for baking bread, focaccias and other recipes such as pies, flans or biscuits



---

## Alternative products

---































**SOP6900TX**  
Stainless steel



**SOP6900TP**  
Cream

## Symbols glossary

 <p>Child lock: some models are fitted with a device to lock the programme/cycle so it cannot be accidentally changed.</p>	 <p>Energy efficiency class A</p>
 <p>Air cooling system: to ensure a safe surface temperatures.</p>	 <p>4.3 inch display with LED technology, usability with knobs + 3 touch keys</p>
 <p>Quadruple glazed: Number of glazed doors.</p>	 <p>Automatic lighting deactivation: For greater energy savings, the lighting turns off automatically after one minute from the start of cooking. The option can be disabled via the settings menu. In this case the light will remain on for the entire duration of cooking.</p>
 <p>Electric</p>	 <p>Ever Clean Enamel: Ever Clean enamel is applied electrostatically, corner to corner and edge to edge to prevent cracking or cracks over time. It is a particular pyrolytic enamel, resistant to acids which, in addition to being pleasantly bright, promotes greater cleaning of the oven walls, thanks to its lower porosity. It is baked at over 850 °C and slowly polymerized at a scientifically determined rate to ensure uniform depth and strength. Ever Clean enamel creates an impeccable finish both on the inside of the oven and on the trays, making the surfaces of the oven incredibly easy to maintain over time as it reduces the adhesion of fat during cooking.</p>
 <p>Fresh Touch: Most of Smeg ovens have a "cool door." Thanks to the combination of tangential cooling and internal heat-reflecting glasses, the temperature on the outer surface of the door is maintained below 50° C. In addition to providing safety, this system protects the sides of the furniture from overheating by the oven.</p>	 <p>Fan assisted base: the mix of fan and lower heating element alone allows to finish cooking foods already cooked on the surface but not internally more quickly. This system is recommended to finish cooking foods that are already well cooked on the surface, but not internally, which therefore require a moderate higher heat. Ideal for any type of food.</p>
 <p>Fan assisted: Intense and homogeneous traditional cooking, also suitable for complex recipes. The fan is active and the heat comes from below and from above at the same time. Ventilated cooking ensures a faster and more homogeneous result, leaving fragrant foods outside and moister inside. Ideal for baked pasta, biscuits, roasts and cobblers.</p>	 <p>Static: Traditional cooking suitable for the preparation of one dish at a time. The fan is not active and the heat comes from below and from above at the same time. Static cooking is slower and more delicate, ideal in order to get well cooked and dry dishes even inside. Ideal for cooking all types of roasts, fatty meats, bread, filled cakes.</p>
 <p>Base: the heat comes only from the bottom of the cavity. The fan is not active. Ideal for sweet and savory pies, cobblers and pizzas. Designed to complete cooking and make food more crunchy. This symbol in gas ovens indicates the gas burner.</p>	 <p>Circulaire: it is the perfect function for cooking all types of dishes in a more delicate way. The heat comes from the back of the oven and is distributed quickly and evenly. The fan is active. It is also ideal for cooking on multiple levels without mixing smells and flavors.</p>

-  **ECO:** low energy consumption cooking: this function is particularly suitable for cooking on a single shelf with low energy consumption. It is recommended for all types of food except those that can generate a lot of moisture (for example vegetables). To achieve maximum energy savings and reduce time, it is recommended to put the food in the oven without preheating the cooking compartment.
-  **Fan grill:** very intense heat coming only from above from a double heating element. The fan is active. It allows the optimal grilling of thickest meats. Ideal for large cuts of meat.
-  **All glass inner door:** All glass inner door, a single flat surface which is simple to keep clean.
-  **KEEP\_WARM\_72dpi**
-  **PYROLYSIS - AUTOMATIC CLEANING FUNCTION:** the oven heats up to a temperature approaching 500 ° C and chars grease and food residues into a fine ash that can be easily wiped off with a damp cloth. At such a high temperature, the door locks automatically for safety, while the temperature of the door remains controlled so it is safe to touch User adjustable function based on the level of dirt present in the oven.
-  **5** The oven cavity has 5 different cooking levels.
-  **68 lt** The capacity indicates the amount of usable space in the oven cavity in litres.
-  **Grill:** Very intense heat coming only from above from a double heating element. The fan is not active. Provides excellent grilling and gratinating results. Used at the end of cooking, it gives a uniform browning to dishes.
-  **Turbo:** the heat comes from 3 directions: above, below and from the back of the oven. The fan is active. It allows quick cooking, even on several shelves without mixing the aromas. Ideal for large volumes or foods that require intense cooking.
-  **The inner door glass:** can be removed with a few quick movements for cleaning.
-  **Side lights:** Two opposing side lights increase visibility inside the oven.
-  **Rapid preheating:** cooking is preceded by the preheating phase which allows the cooking compartment to reach the set temperature. This option reduces the time by up to 50%.
-  **Electronic control:** Allows you to maintain temperature inside the oven with the precision 2-3 ° C. This enables to cook meals that are very sensitive to temperature changes, such as cakes, souffles, puddings.
-  **79 lt** The capacity indicates the amount of usable space in the oven cavity in litres.