

# SOP6902S2PP



<b>Categorie</b>	60 cm
<b>Product familie</b>	Oven
<b>Stroomvoorziening</b>	Elektrisch
<b>Warmtebron</b>	Elektriciteit
<b>Bereidingswijze</b>	Combi-stoomoven
<b>Galileo technologie</b>	Pyro steam
<b>Reinigingssysteem</b>	Pyrolyse reiniging
<b>EAN-code</b>	8017709312329



## Design

<b>Design</b>	Victoria	<b>Type zeefdruk</b>	Symbolen
<b>Kleur</b>	Crème	<b>Deur</b>	Met paneel
<b>Design</b>	Bol	<b>Handvat</b>	Victoria
<b>Materiaal</b>	Gelakt materiaal	<b>Kleur handvat</b>	Inox look
<b>Type glas</b>	Clear1	<b>Logo</b>	Geassembleerd
<b>Kleur serigrafie</b>	Zwart	<b>Bedieningsknoppen</b>	Victoria

## Bediening

			
<b>Display</b>	EvoScreen	<b>Bediening</b>	Knobs & touch buttons
<b>Display</b>	LCD	<b>Aantal bedieningsknoppen</b>	2

## Programma's / Functies

<b>Aantal kookfuncties</b>	12
----------------------------	----

## Traditionele bereidingsfuncties



Statisch



Statisch + ventilator



Circulatie (ventilator + circulaire)



Turbo: ventilator + circulaire +  
statisch



ECO



Grote grill



Onderwarmte



Pizza

## Bereidingsfuncties met stoom



Stoom + onder-en bovenwarmte +  
ventilator



Stoom + circulaire + ventilator

Turbo

Grill + ventilator

## Andere stoomfuncties



Reiniging reservoir



Water afvoer



Water toevoer



Ontkalking

## Overige functies



Ontdooien op tijd



Rijzen



Stone cooking



BBQ



Air-Fry



Sabbath

## Reinigingsfuncties



Pyrolyse

## Opties



Tijdsinstelling	Automatische in- en uitschakeling	Andere opties	Warmhoudfunctie, Eco light, Geluiden, Helderheid
Timer	Ja	Koken met temperatuursonde	Ja
Timer	1	Showroom demo optie	Ja
Kinderbeveiliging	Ja	Snel voorverwarmen	Ja

## Technische specificaties



Inhoud (l)	72 l	Volledig glazen binnendeur	Ja
Minimum temperatuur	25 °C	Uitneembaar glas binnendeur	Ja
Maximum temperatuur	280 °C	Totaal aantal ruiten	4
Aantal kookniveaus	5	Soft Close scharnieren	Ja
Dubbele ventilator	1	Soft open & close scharnieren	Ja
Aantal lampen	2	Chimney	Fixed
Type lamp	Halogeen	Koelsysteem	Mantelkoeling
User-replaceable light	Ja	Koelleiding	Dubbel
Vermogen lamp	40 W	Reductie snelheid koelsysteem	Ja
Verlichting bij opening deur	Ja	Deurblokkering tijdens pyrolyse	Ja
Onderwarmte - vermogen	1200 W	Hoeveelheid stoom	20 - 40%
Grill - vermogen	1750 W	Afmetingen bruikbare interne ovenruimte (hxbxd)	353x470x401 mm
Circulatie - vermogen	2000 W	Temperatuurcontrole	Elektronisch
Warmte onderbroken bij openen deur	Ja	Materiaal ovenruimte	Ever Clean emaille
Opening deur	Standaard opening	Water toevoer	Manueel met lade
Deur	Koud	Capaciteit reservoir	0,8 l
Uitneembare ovendeur	Ja		

## Prestaties / energielabel



Energie-efficiëntieklasse	A+	Energy consumption in forced air convection	2,45 MJ
Netto volume	68 l	Energieconsumptie in turbo functie	0,68 kWh
Energieconsumptie in conventionele functie	1,09 kWh	Aantal ovens	1
Energy consumption in conventional mode	3,92 MJ	Energie-efficiëntie Index	81 %

## Meegeleverde accessoires



Ovenrooster met stop	1	Inzetrooster	1
----------------------	---	--------------	---

Bakplaat (20 mm)	1	Temperatuur sonde	Ja,
Geëmailleerde diepe ovenschaal (50 mm)	1		éénpuntstemperatuursonde

## Elektrische aansluiting

Spanning	220-240 V	Nominale aansluitwaarde	3000 W
Stekker	Nee	Frequentie	50/60 Hz
Stroom	13 A	Lengte voedingskabel	150 cm

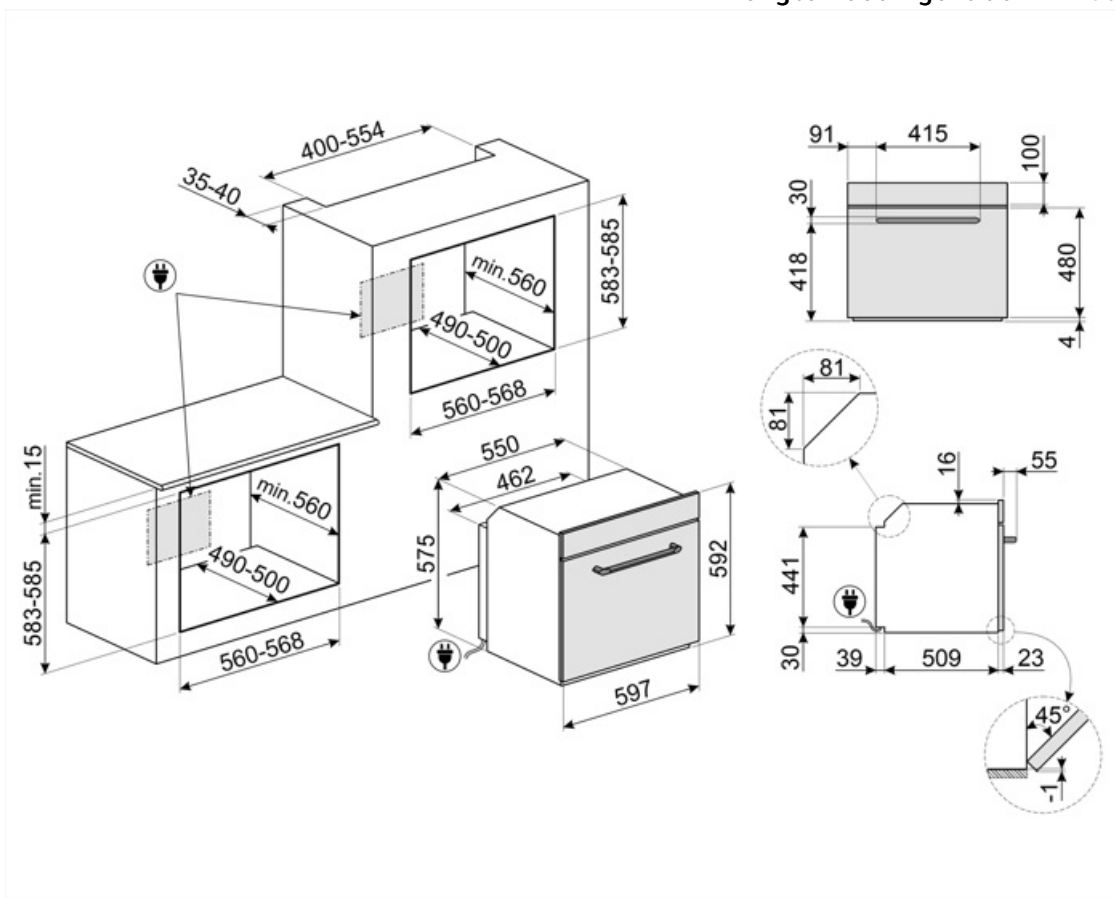

## Compatible Accessories

### AIRFRY



### BBQ

Dubbelzijdig



### ET50

Geëmailleerde ovenschaal voor 45cm en 60cm ovens. Diepte 50 mm.



### GTT2

Volledig uitschuifbare telescopische rails (1 niveau) voor traditionele ovens (SO-)



### PALPZ

Pizzapallet inox met plooibaar handvat, 315x325 mm



### STONE

Rectangular refractory stone Ideal for cooking pizzas with the same results as a typical wood-fired oven. Can also be used for baking bread, focaccias and other recipes such as pies, flans or biscuits Dimensions:L42 x H1,8 x P37,5 cm.



### AIRFRY2

Air fryer tray. Ideal for recreating traditional frying in the oven, but with fewer calories and less fat. It allows you to cook quickly and simply dishes such as French fries, fried vegetables and fish, ensuring perfect browning and crispiness.



### ET20

Geëmailleerde ovenschaal voor 45cm en 60cm ovens. Diepte 20 mm.



### GTP2

Partially extractable telescopic guides (1 level), suitable for traditional ovens. Made in stainless steel, they guarantee stability and facilitate the smooth extraction of the trays.



### GTTV2

Volledig uitschuifbare telescopische rails (1 niveau) voor (stoom-)ovens (SO-).



### PR3845X

Inox profiel voor installatie ovens in kolom



### STONE2

Rectangular pizza stone without handles, suitable for 45cm and 60cm wide ovens. Dimensions W42 x H1.8 x D37.5cm. Ideal for cooking pizzas with the same results as a typical wood-fired oven. Can also be used for baking bread, focaccias and other recipes such as pies, flans or biscuits



---

## Alternative products

---



**SOP6902S2PX**















Inox



















**SOP6902S2PN**













Zwart

## Symbols glossary

 A+: Energy efficiency class A+ helps to save up to 10% energy compared to class A. Maximum performance with minimum consumption is guaranteed.	 Sommige modellen zijn voorzien van een functie om het programma/de cyclus te blokkeren zodat het niet per ongeluk kan aangepast worden.
 Gecombineerde stoom: ovens kunnen als stoomoven of als traditionele oven gebruikt worden, of als alternatief kunnen de twee methoden gecombineerd worden.	 Air cooling system: to ensure a safe surface temperatures.
 Defrost by time: Manual defrost function. At the end of the set duration, the function stops.	 Ontkalkingsfunctie: Is essentieel om overtollige kalkaanslag in de tank te verwijderen en de goede werking van het product mogelijk te maken. De noodzaak om deze bewerking uit te voeren, wordt door het product zelf aangegeven.
 Quadruple glazed: Number of glazed doors.	 Automatic lighting deactivation: For greater energy savings, the lighting turns off automatically after one minute from the start of cooking. The option can be disabled via the settings menu. In this case the light will remain on for the entire duration of cooking.
 Elektrische aansluiting	 Ever Clean Enamel: Ever Clean enamel is applied electrostatically, corner to corner and edge to edge to prevent cracking or cracks over time. It is a particular pyrolytic enamel, resistant to acids which, in addition to being pleasantly bright, promotes greater cleaning of the oven walls, thanks to its lower porosity. It is baked at over 850 °C and slowly polymerized at a scientifically determined rate to ensure uniform depth and strength. Ever Clean enamel creates an impeccable finish both on the inside of the oven and on the trays, making the surfaces of the oven incredibly easy to maintain over time as it reduces the adhesion of fat during cooking.
 Fingerprint proof stainless steel: Fingerprint proof stainless steel keeps stainless steel looking as good as new.	 Fresh Touch: Most of Smeg ovens have a "cool door." Thanks to the combination of tangential cooling and internal heat-reflecting glasses, the temperature on the outer surface of the door is maintained below 50° C. In addition to providing safety, this system protects the sides of the furniture from overheating by the oven.
 Ventilator met bovenste en onderste elementen: De elementen in combinatie met de ventilator zijn bedoeld om een meer gelijkmatige warmte te bieden, een methode die vergelijkbaar is met conventioneel koken, dus voorverwarmen is vereist. Het meest geschikt voor items die langzaam koken vereisen.	 Alleen boven- en onder element: een traditionele kookmethode die het meest geschikt is voor losse items in het midden van de oven. de bovenkant van de oven zal altijd het heetst zijn. Ideaal voor gebraden vlees, fruitcake, brood etc.

- |  |   |
|--|---|
|  <p>Base: the heat comes only from the bottom of the cavity. The fan is not active. Ideal for sweet and savory pies, cobblers and pizzas. Designed to complete cooking and make food more crunchy. This symbol in gas ovens indicates the gas burner.</p>  |  <p>Circulaire: De combinatie van de ventilator en het ronde element eromheen zorgt voor een hete lucht kookmethode. Dit biedt vele voordelen, waaronder geen voorverwarmen als de kooktijd meer dan 20 minuten bedraagt, geen smaakoverdracht bij het gelijktijdig bereiden van verschillende soorten voedsel, minder energie en kortere kooktijden. Geschikt voor alle soorten voedsel.</p>  |
|  <p>De combinatie van de grill, de ventilator en onderwarmte is interessant voor het bereiden van kleine hoeveelheden.</p>   |  <p>Grill: Very intense heat coming only from above from a double heating element. The fan is not active. Provides excellent grilling and gratinating results. Used at the end of cooking, it gives a uniform browning to dishes.</p>  |
|  <p>Pizza function: Specific function for cooking pizza in a pan. It allows to obtain a pizza that is soft inside and crispy outside with the topping perfectly cooked, not dry and not burnt.</p>   |  <p>Een combinatie tussen een turbine en traditioneel bakken, waarbij de warmte boven- en onderin wordt gegenereerd en samen zorgt voor een gelijkmatige warmte. Door toevoeging van stoomfunctie is hetzelfde kookresultaat mogelijk in minder tijd. Ideaal voor gebraden vlees.</p>  |
|  <p>Circulaire-element met stoom: koken met gelijktijdig gebruik van het ronde verwarmingselement in combinatie met ventilator en stoomtoevoer.</p>   |  <p>Dit pictogram/signaal geeft aan dat u water uit de reservoir moet bijvullen of ledigen.</p>   |
|  <p>Circulaire met bovenste en onderste elementen: door het gebruik van de ventilator met beide elementen kan voedsel snel en effectief worden gekookt, ideaal voor grote stukken vlees die grondig moeten worden gekookt. Het biedt een vergelijkbaar resultaat als rotisserie, waarbij de warmte rond het voedsel wordt verplaatst in plaats van het voedsel zelf te verplaatsen, waardoor elke maat of vorm kan worden gekookt.</p> |  <p>All glass inner door: All glass inner door, a single flat surface which is simple to keep clean.</p>   |
|  <p>The inner door glass: can be removed with a few quick movements for cleaning.</p>  |  <p>Met deze functie kan u bereidingen warmhouden zodat het eten niet meteen afkoelt</p>   |
|  <p>Side lights: Two opposing side lights increase visibility inside the oven.</p>   |  <p>PYROLYSIS - AUTOMATIC CLEANING FUNCTION: the oven heats up to a temperature approaching 500 ° C and chars grease and food residues into a fine ash that can be easily wiped off with a damp cloth. At such a high temperature, the door locks automatically for safety, while the temperature of the door remains controlled so it is safe to touch User adjustable function based on the level of dirt present in the oven.</p> |
|  <p>Koken met temperatuursonde: het is mogelijk om de temperatuur die herkend is door de sonde weer te geven op het display en een doeltemperatuur voor het gerecht in te stellen. Wanneer het centrum van het gerecht de juiste temperatuur heeft bereikt, stopt de functie.</p>  |  <p>Air at 40°C provides the perfect environment for proving yeast type dough mixes. Simply select the function and place dough in the cavity for allotted</p>   |



- 
- |  |  |
|--|--|
|  <p>Rapid preheating: cooking is preceded by the preheating phase which allows the cooking compartment to reach the set temperature. This option reduces the time by up to 50%.</p>  |  <p>SABBATH: function that allows to cook food respecting Judaism's day of rest provisions.</p>   |
|  <p>The oven cavity has 5 different cooking levels.</p>  |  <p>Alle modellen zijn voorzien van een soft close deursysteem waarbij de deur zacht en stil sluit.</p>   |
|  <p>To guarantee the optimal functioning of the appliance, it is suggested to carry out the tank cleaning roughly once every 2-3 months.</p>   |  <p>Electronic control: Allows you to maintain temperature inside the oven with the precision 2-3 ° C. This enables to cook meals that are very sensitive to temperature changes, such as cakes, souffles, puddings.</p>  |
|  <p>The capacity indicates the amount of usable space in the oven cavity in litres.</p>  |  <p>The capacity indicates the amount of usable space in the oven cavity in litres.</p>   |
|  <p>EVOscreen display + bedieningsknoppen</p>  |  <p>Manual water loading system: It is possible to load the tank in less than 40 seconds. The loading is done manually thanks to a special funnel included.</p>   |
|  <p>Speciale kookfunctie voor de dubbelzijdige plaat-BBQ. Geschikt voor het nabootsen van sappige en knapperige gerechten in de oven met de typische smaak van gegrild koken. De geribbelde kant is bijzonder geschikt voor vleeswaren en kazen; de gladde kant voor vis, zeevruchten en groenten.</p> |  <p>Speciale kookfunctie voor het Airfryerrek AIRFRY. Ideaal voor het nabootsen van traditioneel frituren in de oven, maar met minder calorieën en minder vet. Hiermee kook je snel en eenvoudig gerechten zoals frites, gebakken groenten en vis, waardoor ze perfect bruin en krokant worden.</p> |
|  <p>Speciale kookfunctie voor de pizzasteen STONE. Ideaal voor het bakken van pizza's met hetzelfde resultaat als een typische houtgestookte oven. Kan ook worden gebruikt voor het bakken van brood, focaccia's en andere recepten zoals taarten, vlaaien of koekjes</p>                            |  |