

SPO5L2SDL



Família	Fornos
Subfamília	Forno a vapor combinado 5 tabuleiros GN1/1
Tipo de energia	Elétrico
Tipo de forno	Forno Galileo profissional
Capacidade de tabuleiro	5 tabuleiros GN1/1
Fonte de energia	400 V 3N~ / 17 A / 8 kW / 50-60 Hz
Outras ligações eléctricas	230 V 3~ / 18 A / 8 kW / 50-60 Hz
Sistema do vapor	Direct and Open boiler
Pés reguláveis em altura	Sim
Dimensões do produto (LxPxA)	790x875x645 mm
Profundidade máxima com a porta aberta	1623 mm



Mercado

Indústrias	Hotelaria; Restaurantes; Talhos; Estabelecimentos de Cuidados; Indústrias Alimentares; Supermercados / Comércio de alimentos
-------------------	--

Design

Porta com tiras em aço inox	Sim	Cor dos dígitos no display	Multicolor
Cor	Aço Inox/Preto	Painel frontal	Vidro/Aço Inox
Display	TFT digital, 7" touch	Design	Galileo Professional

Comandos

Nº de programas em memória	512	Função de pausa	Ajustável
Receitas	Sim	Forced cooling	Sim
Temporizador	de 1 min até 23h59 min por passo	Regulação da chaminé	Automático
Função MultiStep	8 + preheating + keep warm	Programas de lavagem	Sim
Início diferido	Sim; Não	HACCP data	Sim
Pré-aquecimento	Sim	Auto diagnóstico	Sim

Opções

Exaustor compatível K510X

Acessórios incluídos

Sonda térmica Sonda térmica de 4 pontos externos

Ligação elétrica

Ficha elétrica Não

ESPECIFICAÇÕES TÉCNICAS

Material do forno	Aço Inox / Vidro / Plástico	Posição de exaustão	Traseira
Dimensões da cavidade (LxPxA)	670x560x420 mm	Sistema de arrefecimento	Sim
Material da cavidade	Aço inox	Tipo de temporizador	Elétrico
Níveis de tabuleiros	5	Temperaturas	30-270°C
Suporte dos tabuleiros	Aço inox AISI 304	Aviso de final de cozedura	Sim
Kit de adaptação para tabuleiros 600x400 mm	Sim	Interruptor de segurança com porta aberta	Sim
Distância entre tabuleiros	70 mm GN1/1 - 90 mm EN 600x400	Reset de segurança do termostato	Sim
Material da porta	Vidro triplo	Deflector removível	Sim
Abertura da porta	Lateral	Tipo de detergente	Líquido
Tipo de puxador	Rotativo	Iluminação	1 lâmpada LED
Vidro	Abre com dobradiça	Potência das lâmpadas	3.6 W
Tipologia da ventoinha	Rotação reversível	Porta USB	Sim
Ventilação intermitente	Sim	Sistema de arrefecimento	Sim
Potência da ventoinha	200 W	Nº de entradas de água	1
RPM da ventoinha	Progressão %	Tubo de carga de água	Sim
RPM standard da ventoinha	2850 rpm	Depósito de detergente exterior	Sim
RPM da ventoinha na velocidade inferior	1425 rpm	Pressão da entrada de água	200-1000 kPa (min-max)
Injeção de água em cada ventoinha	Sim	Comprimento do cabo de alimentação	170 cm
Steam control	5-100% (min-max)	Painel traseiro	Porta galvanizada
Caldeira aberta	Sim	Proteção IPX	IPX4
Ø de drenagem	1" 1/2 - DN 40 mm		

Dados de logística

Dimensões do produto embalado (LxPxA)	850x950x700 mm	Peso líquido (kg)	90,000 kg
Código EAN	8017709325909	Peso bruto (kg)	110,000 kg

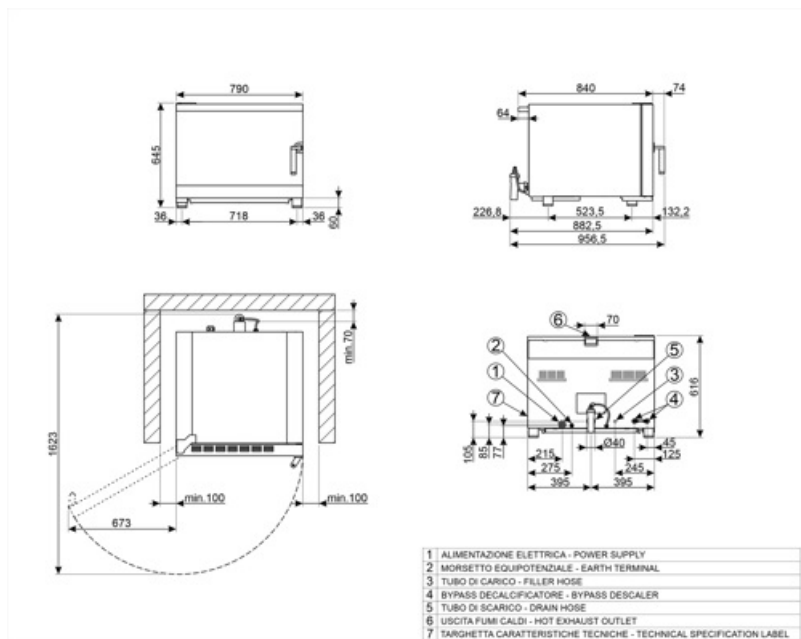

Acessórios Compatíveis



CLB45LSE

Flow meter for filter FB45LSE1100



FB45LSE500

Water treatment filter for Galileo Professional oven; 4.675 litres capacity with 10 Kh hardness and bypass set 1

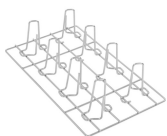

G11X8P

8 vertical GN1/1 chicken grid

KITDPEC

Galileo professional external detergent lance kit



R4EN6040

Galileo Professional oven tray support kit for 4 EN 600x400 mm trays



STDH

8-shelf tray holder stand with 80 mm pitch, for Galileo Professional oven, for GN 1/1 and EN 600x400 mm trays, dim. (WxDxH) 800x750x850



T11TH40

GN1/1 non-stick tray, 40 mm height



T11XH65

GN1/1 aluminium tray, 65 mm height



TB45LSE



FB45LSE1100

Water treatment filter for Galileo Professional oven; 7.907 litres capacity with 10 Kh hardness and bypass set 1

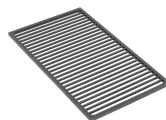

G11T

Non-stick GN1/1 tray



KCAM5

Chimney kit for Galileo Professional 4 and 5 trays



KITSTCK55

Conjunction kit between 2 stacked Galileo ovens (SPO4 or SPO5)



RUTVL

Set of 4 wheels, fits all professional oven tables



STDM

4-level tray holder stand with 80 mm pitch, for Galileo Professional oven, for GN 1/1 and EN 600x400 mm tray, dim. (WxPxH) 800x750x500 mm



T11XH20

Aluminium GN1/1 tray, 20 mm height



T8S11T

8 holes GN 1/1 non-sticking tray

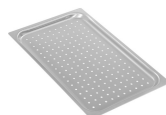

TF11XH2





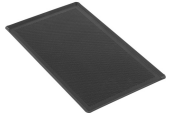





GN 1/1 perforated aluminium tray, 20 mm height

TMF11TH2



GN 1/1 non-sticking microperforated
tray, 20 mm height

Symbols glossary

	Elétrico: a fonte de energia do forno é a eletricidade.		Humidity and heat controlled proving
	Fan speed adjustable between 50 and 100% of the speed		Automatic washing
	Barbecue: aquecimento seco para grelhados perfeitos.		Core probe baking by temperature difference (Δt)
	Fan forced heating		Steam and hot air combined cooking
	Steam generated by injectiong water into the fan and evaporation on the heating element		Saturated steam created by boiling in the cavity
	Sous-vide baixa temperatura		

Benefit (TT)

Hinged opening

Easily accessible glass for effortless maintenance and cleaning

The glass panels are designed to be easily accessible and inspectable, ensuring great convenience during cleaning and maintenance operations. This feature significantly simplifies the process, making it quick and efficient, while ensuring that every intervention can be carried out with maximum comfort and complete safety.

WashArt System

Efficient washing, optimised consumption, and minimal space usage

The WashArt washing system, equipped with a rotating nozzle, ensures even distribution of water and detergent within the cavity, providing deep cleaning and quick drying. To meet every need, four washing programmes are available: Short, Medium, Long, and Grill, along with a dedicated rinse programme. Thanks to its advanced technology, WashArt optimises efficiency and reduces consumption, while the rotating nozzle, with its compact design, minimises space usage in the cooking chamber.

Fan speed

Precise fan speed modulation for consistently even cooking results

In the Galileo Professional ovens, the fan speed can be adjusted from a minimum of 50% to a maximum of 100%, in 5% increments. This feature allows for precise customisation of the airflow, perfectly adapting it to the specific needs of each preparation. Thanks to this versatility, it is possible to achieve flawless cooking results, ensuring even and accurate heat distribution. Moreover, precisely adjusting the fan speed helps preserve the delicacy of sensitive foods, preventing exposure to excessive heat and creating the ideal conditions to maintain their lightness and internal structure.

Core probe

Multipoint cooking sensor for precise and uniform results

Optimal precision and control thanks to the four temperature measurement points, ensuring an accurate reading at every stage of cooking. The advanced sensor precisely detects the heat at the core of the food, guaranteeing the ideal cooking level for consistently perfect and uniform results.

SteamArt Technology

Open Boiler system to generate steam directly within the cavity, in quick times and at very low temperatures

Thanks to the innovative Open Boiler system, steam is generated directly within the cavity, in very short times and at very low temperatures (starting from 30°C, ideal for supporting the proofing phase). This system is particularly suited for delicate cooking processes that require the use of 100% steam, ensuring even and gentle cooking that preserves the nutritional properties, taste, and texture of the food.

8 cooking stages

Flexibility and precision in every cooking stage

The ability to set multiple cooking phases, in addition to preheating and keeping warm, gives the combi-steam oven exceptional versatility, responding precisely to the diverse needs of every preparation. Each phase of the cooking process can be customised with great accuracy, optimising results whether it's slow cooking at low temperatures or achieving a perfect final browning. Thanks to the advanced control of steam and heat parameters, it is possible to achieve even cooking on every surface, significantly enhancing the quality of the finished product and ensuring flawless results.

Waste water cooling

The temperatures are significantly lowered and the thermal impact reduced thanks to the waste water cooling system

Some ovens are equipped with a waste water cooling system that significantly lowers the temperature of the water before it is released, minimising the thermal impact. This mechanism optimises energy efficiency, enhances operational safety, and supports eco-friendly practices, helping to make the oven more sustainable and high-performing.

System for external detergent tanks

Efficient cleaning operations and optimal resource management

Some oven models are designed to use an external detergent tank and are equipped with dedicated suction hoses. This solution provides greater autonomy, reducing the need for frequent refills, and significantly simplifies the detergent replenishment process. As a result, cleaning operations become more efficient and continuous, without interruptions, ensuring optimal resource management and high hygiene performance.