

SPO5R2SDL



Family	Professional ovens
Subfamily	Combi steam oven 5 trays GN1/1
Power supply	Electric
Oven type	Galileo Professional combi steam oven
Power supply	400 V 3N~ / 17 A / 8 kW / 50-60 Hz
Other electrical connection	230 V 3~ / 18 A / 8 kW / 50-60 Hz
Adjustable feet	Yes
Product dimensions (WxDxH)	790x875x645 mm
Maximum depth with open door	1623 mm



Target

Industries	Hotels; Restaurants; Butcher shops / Delicatessens; Care facilities ; Commercial food services; Grocery shops / Food retail
-------------------	--

Aesthetics

Door with stainless steel stripes	Yes	Digit display color	Multicolor
Colour	Stainless steel/Black	Front panel Series	Glass/Stainless steel Galileo Professional
Display type	TFT digital, 7 inches touch		

Controls

Storable programs number	512	Hold function	Adjustable
Preset recipes	>100	Forced cooling	Yes
Timer setting range	0-23:59' (min. - max.)	Chimney regulation	Automatic
Cooking steps	8 + preheating + keep/warm	Wash programs	Short/medium/long/grill/rinse
Delayed start	Yes; No	HACCP data	Yes
Pre-heating	Yes	Self diagnostic	Yes

Options

Right hand hinge	Yes	Combinable hood	K510X
------------------	-----	-----------------	-------

Accessories included

Probe	4 points external core probe
-------	------------------------------

Electrical Connection

Plug	Not present
------	-------------

Construction

Oven materials	Stainless steel / glass / plastics	Components cooling system	Yes
Cavity dimensions (WxDxH)	670x560x420 mm	Timer type	Electrical
Cavity material	Stainless steel	Temperature range	30-270°C
Shelves number	5	End cooking signal	Yes
Tray frame support	Stainless steel AISI 304	Safety switch with open door	Yes
Adapter kit for trays 600x400 mm	Yes	Manual reset safety thermostat	Yes
Shelves distance	70 mm	Removable deflector	Yes
Door construction	Triple glass	Detergent type	Liquid
Door opening	Lateral - left hinge	Light switch with open door	Yes
Handle type	Rotating	Lighting	1 LED lamp
Glass	Openable with hinge	Light power	3.6 W
Fan motor power	200 W	USB port	Yes
Engine rpm	Progressive %	Drain water cooling system	Yes
Motor rpm in standard speed	2850 rpm	Water entries number	1
Motor rpm in low speed	1425 rpm	Water load pipe	Yes
Water injection on each fan	Yes	External detergent containers system	Yes
Humidification levels	None	Water inlet pressure	200-1000 kPa (min-max)
Steam control	5-100% (min-max)	Power cable length	170 cm
Open boiler	Yes	Back panel	Galvanized
Drain diameter	1" 1/2 - DN 40 mm	IPX protection	IPX4
Exhaust position	Back		

Logistic Information

Packed product dimensions (WxDxH)	850x950x700 mm	Net weight	91,000 kg
EAN code	8017709339982	Gross weight	110,000 kg

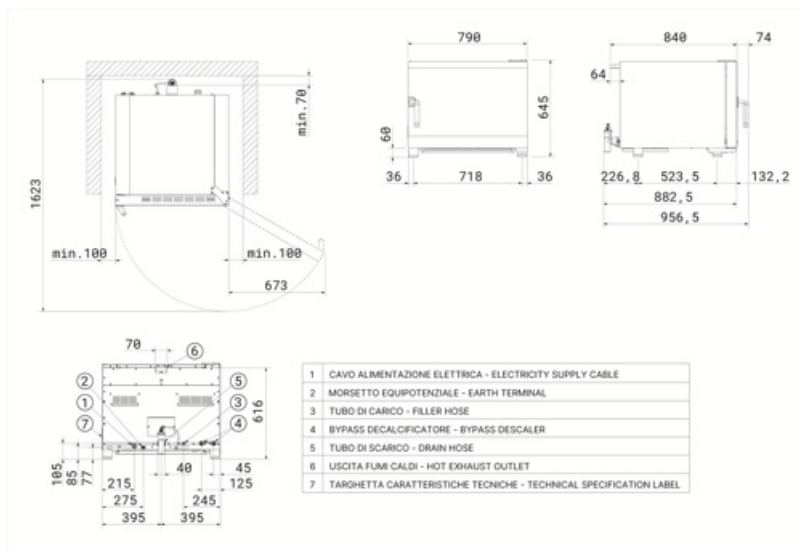

Compatible Accessories



CLB45LSE

Flow meter for filter FB45LSE1100



FB45LSE1100

Water treatment filter for Galileo Professional oven; 7.907 litres capacity with 10 Kh hardness and bypass set 1



FB45LSE500

Water treatment filter for Galileo Professional oven; 4.675 litres capacity with 10 Kh hardness and bypass set 1

G11T

Non-stick GN1/1 tray

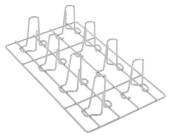
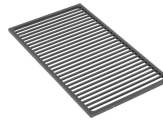

G11X8P

8 vertical GN1/1 chicken grid



KCAM5

Chimney kit for Galileo Professional 4 and 5 trays

KITDPEC

Galileo professional external detergent lance kit



KITSTCK55

Conjunction kit between 2 stacked Galileo ovens (SPO4 or SPO5)



R4EN6040

Galileo Professional oven tray support kit for 4 EN 600x400 mm trays



RUTVL

Set of 4 wheels, fits all professional oven tables



STDH

8-shelf tray holder stand with 80 mm pitch, for Galileo Professional oven, for GN 1/1 and EN 600x400 mm trays, dim. (WxDxH) 800x750x850



STDM

4-level tray holder stand with 80 mm pitch, for Galileo Professional oven, for GN 1/1 and EN 600x400 mm tray, dim. (WxPxH) 800x750x500 mm



T11TH20

GN1/1 non-stick tray, 20 mm height



T11TH40

GN1/1 non-stick tray, 40 mm height



T11XH20

Aluminium GN1/1 tray, 20 mm height



T11XH65

GN1/1 aluminium tray, 65 mm height



T8S11T

8 holes GN 1/1 non-sticking tray



TB45LSE







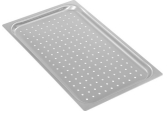



Water treatment filter head for Galileo Professional ovens

TF11XH2

GN 1/1 perforated aluminium tray, 20
mm height



Symbols glossary

	Electric		Fan speed adjustable between 50 and 100% of the speed
	Fan forced heating		Core probe baking by temperature difference (Δt)
	Automatic washing		Dry heat for a perfect grill
	Steam generated by injection of water into the fan and evaporation on the heating element		Saturated steam created by boiling in the cavity
	Steam and hot air combined cooking		Low cooking sous-vide
	Humidity and heat controlled proving		

Benefit (TT)

Hinged opening

Easily accessible glass for effortless maintenance and cleaning

The glass panels are designed to be easily accessible and inspectable, ensuring great convenience during cleaning and maintenance operations. This feature significantly simplifies the process, making it quick and efficient, while ensuring that every intervention can be carried out with maximum comfort and complete safety.

WashArt System

Efficient washing, optimised consumption, and minimal space usage

The WashArt washing system, equipped with a rotating nozzle, ensures even distribution of water and detergent within the cavity, providing deep cleaning and quick drying. To meet every need, four washing programmes are available: Short, Medium, Long, and Grill, along with a dedicated rinse programme. Thanks to its advanced technology, WashArt optimises efficiency and reduces consumption, while the rotating nozzle, with its compact design, minimises space usage in the cooking chamber.

Fan speed

Precise fan speed modulation for consistently even cooking results

In the Galileo Professional ovens, the fan speed can be adjusted from a minimum of 50% to a maximum of 100%, in 5% increments. This feature allows for precise customisation of the airflow, perfectly adapting it to the specific needs of each preparation. Thanks to this versatility, it is possible to achieve flawless cooking results, ensuring even and accurate heat distribution. Moreover, precisely adjusting the fan speed helps preserve the delicacy of sensitive foods, preventing exposure to excessive heat and creating the ideal conditions to maintain their lightness and internal structure.

Core probe

Multipoint cooking sensor for precise and uniform results

Optimal precision and control thanks to the four temperature measurement points, ensuring an accurate reading at every stage of cooking. The advanced sensor precisely detects the heat at the core of the food, guaranteeing the ideal cooking level for consistently perfect and uniform results.

SteamArt Technology

Open Boiler system to generate steam directly within the cavity, in quick times and at very low temperatures

Thanks to the innovative Open Boiler system, steam is generated directly within the cavity, in very short times and at very low temperatures (starting from 30°C, ideal for supporting the proofing phase). This system is particularly suited for delicate cooking processes that require the use of 100% steam, ensuring even and gentle cooking that preserves the nutritional properties, taste, and texture of the food.

8 cooking stages

Flexibility and precision in every cooking stage

The ability to set multiple cooking phases, in addition to preheating and keeping warm, gives the combi-steam oven exceptional versatility, responding precisely to the diverse needs of every preparation. Each phase of the cooking process can be customised with great accuracy, optimising results whether it's slow cooking at low temperatures or achieving a perfect final browning. Thanks to the advanced control of steam and heat parameters, it is possible to achieve even cooking on every surface, significantly enhancing the quality of the finished product and ensuring flawless results.

Waste water cooling

The temperatures are significantly lowered and the thermal impact reduced thanks to the waste water cooling system

Some ovens are equipped with a waste water cooling system that significantly lowers the temperature of the water before it is released, minimising the thermal impact. This mechanism optimises energy efficiency, enhances operational safety, and supports eco-friendly practices, helping to make the oven more sustainable and high-performing.

System for external detergent tanks

Efficient cleaning operations and optimal resource management

Some oven models are designed to use an external detergent tank and are equipped with dedicated suction hoses. This solution provides greater autonomy, reducing the need for frequent refills, and significantly simplifies the detergent replenishment process. As a result, cleaning operations become more efficient and continuous, without interruptions, ensuring optimal resource management and high hygiene performance.