

# SPR24UIMAN

Cooker size	24"
Cavity heat source	ELECTRICITY
Hob type	Induction
Type of main oven	Thermo-ventilated
Cleaning system main oven	Vapor Clean
EAN code	8017709347703



## Aesthetics











Front panel color	Matt black	No. of controls	2
Colour	Matt Black	Display	Touch
Finishing	Satin	Handle	Smeg new design with knurled handle
Serie	Professional	Handle Colour	Brushed stainless steel
Hob colour	Stainless steel	Feet	Stainless steel
Control knobs	Smeg new design with knurled ferrule		

## Programs / Functions

No. of cooking functions 8

Traditional cooking functions

 Static	 Fan assisted	 Circulaire
 Small grill	 Large grill	 Fan grill (large)
 Fan assisted bottom	 Pizza	

Other functions

 Defrost by time
--

## Cleaning functions

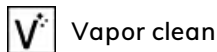

## Hob options



End cooking timer	4	Limited Power Consumption Mode	Yes
Minute minder	1	Multizone Option	Yes

## Hob technical features



Total no. of cook zones 4

Front left - 1.30 kW - Booster 1.40 kW - Ø 18.0 cm

Rear left - 2.30 kW - Booster 3.00 kW - Ø 18.0 cm

Front right - 2.30 kW - Booster 3.00 kW - Ø 14.5 cm

Rear right - 1.30 kW - Booster 1.40 kW - Ø 21.0 cm

Number of Flexible zones	1	Automatic pan detection	Yes
Booster power left Multizone	3,70 kW	Minimum pan diameter indication	Yes
Automatic switch off when overheat	Yes	Selected zone indicator	Yes
Automatic switch off when overflow	Yes	Residual heat indicator	Yes

## Main Oven Technical Features



No. of lights	1	Total no. of door glasses	3
Fan number	1	Cooling system	Tangential
Gross volume, 1st cavity	2.79 cu. ft.	Lower heating element power	1200 W
Cavity material	Ever Clean enamel	Upper heating element - Power	1000 W
No. of shelves	5	Grill element	1700 W
Light type	Halogen	Large grill - Power	2700 W
Light Power	40 W	Circular heating element - Power	2000 W
Cooking time setting	Minute minder	Grill type	Electric
Removable door	Yes	Soft Close system	Yes
Removable inner door	Yes		

## Options Main Oven

Minimum Temperature	151 °F	Maximum temperature	500 °F
---------------------	--------	---------------------	--------

## Accessories included for Main Oven & Hob

Oven grid with stop, tray support	2	Meat Probe	1
-----------------------------------	---	------------	---

## Electrical Connection

Circuit breaker	30 A	Power supply cable length	47 1/4 "
Voltage	208/240 V	Frequency	60 Hz
Type of electric cable installed	Yes, Double phase	Plug	(B) NEMA 14-50P

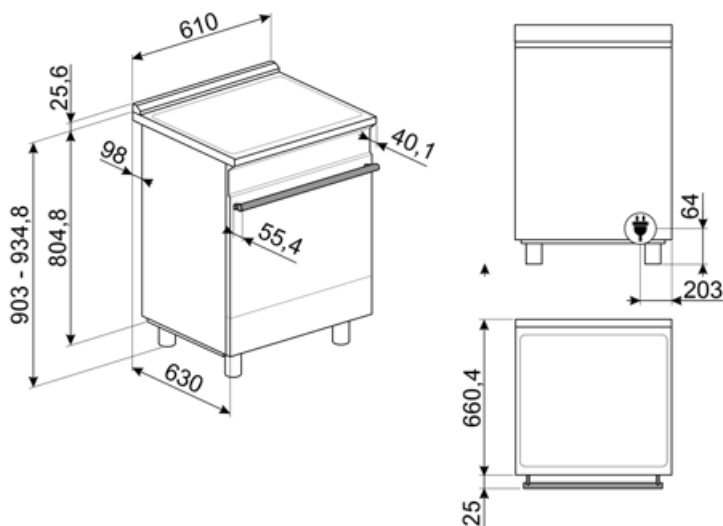

## Compatible Accessories



### GRILLPLATE

Universal griddle for induction, gas, ceramic and electric hobs. Non-stick surface ideal for cooking meat, cheese and vegetables. Dimensions: 410 x 240 mm.



### KITTKSPR24

Plinth, 90cm, three sides, black, suitable for SPR cookers 24"



### SCRP

Non-scratch hob scraper - suitable for induction and ceramic hobs



### STONE2

Rectangular pizza stone without handles, suitable for 45cm and 60cm wide ovens. Dimensions W42 x H1.8 x D37.5cm. Ideal for cooking pizzas with the same results as a typical wood-fired oven. Can also be used for baking bread, focaccias and other recipes such as pies, flans or biscuits



### GTP

Partially extractable telescopic guides (1 level), suitable for traditional ovens. Made in stainless steel, they guarantee stability and facilitate the smooth extraction of the trays.



### PALPZ

Pizza shovel with folding handle. Dimensions L31.5 x H32.5 cm. Easy and convenient to use and store. Perfect for serving pizza, bread and savory pastries in a safe and professional way.



### SFLK1

Child lock

---

## Alternative products

---



**SPR24UIMMW**

Colour: Matt White



**SPR24UIMX**



















Colour: Stainless steel



**SPR24UIMANX**

Colour: Matt Black

## Symbols glossary

 <p>Automatic merge of zones for a bigger area</p>	 <p>Compact Slider back-lighted ghost effect</p>
 <p>Air cooling system: to ensure a safe surface temperatures.</p>	 <p>Defrost by time: Manual defrost function. At the end of the set duration, the function stops.</p>
 <p>4.3 inch display with LED technology, usability with knobs + 3 touch keys</p>	 <p>Triple glazed doors: Number of glazed doors.</p>
 <p>ECO-logic: option allows you to restrict the power limit of the appliance real energy saving.</p>	 <p>B: Product energy rating, measured from A+++ to D / G depending on the product family.</p>
 <p>Ever Clean Enamel: Ever Clean enamel is applied electrostatically, corner to corner and edge to edge to prevent cracking or cracks over time. It is a particular pyrolytic enamel, resistant to acids which, in addition to being pleasantly bright, promotes greater cleaning of the oven walls, thanks to its lower porosity. It is baked at over 850 ° C and slowly polymerized at a scientifically determined rate to ensure uniform depth and strength Ever Clean enamel creates an impeccable finish both on the inside of the oven and on the trays, making the surfaces of the oven incredibly easy to maintain over time as it reduces the adhesion of fat during cooking</p>	 <p>Fan assisted base: the mix of fan and lower heating element alone allows to finish cooking foods already cooked on the surface but not internally more quickly. This system is recommended to finish cooking foods that are already well cooked on the surface, but not internally, which therefore require a moderate higher heat. Ideal for any type of food.</p>
 <p>Fan assisted: Intense and homogeneous traditional cooking, also suitable for complex recipes. The fan is active and the heat comes from below and from above at the same time. Ventilated cooking ensures a faster and more homogeneous result, leaving fragrant foods outside and moister inside. Ideal for baked pasta, biscuits, roasts and cobblers.</p>	 <p>Static: Traditional cooking suitable for the preparation of one dish at a time. The fan is not active and the heat comes from below and from above at the same time. Static cooking is slower and more delicate, ideal in order to get well cooked and dry dishes even inside. Ideal for cooking all types of roasts, fatty meats, bread, filled cakes.</p>
 <p>Circulaire: it is the perfect function for cooking all types of dishes in a more delicate way. The heat comes from the back of the oven and is distributed quickly and evenly The fan is active. It is also ideal for cooking on multiple levels without mixing smells and flavors.</p>	 <p>Grill: Very intense heat coming only from above from a double heating element. The fan is not active. Provides excellent grilling and gratinating results. Used at the end of cooking, it gives a uniform browning to dishes.</p>
 <p>Half grill: For rapid cooking and browning of foods. Best results can be obtained by using the top shelf for small items, the lower shelves for larger ones, such as chops or sausages. For half grill heat is generated only at the centre of the element, so is ideal for smaller quantities.</p>	 <p>Fan grill: very intense heat coming only from above from a double heating element The fan is active. It allows the optimal grilling of thickest meats. Ideal for large cuts of meat.</p>
 <p>Pizza function: Specific function for cooking pizza in a pan. It allows to obtain a pizza that is soft inside and crispy outside with the topping perfectly cooked, not dry and not burnt.</p>	 <p>Overheat protection: The safety system that automatically turns off the hob in case of overheating of the control unit.</p>



**Induction:** The work of these hobs is based on the principle of electromagnetic induction. The heat is generated directly in the bottom of the pan during its contact with the hob.



**All glass inner door:** All glass inner door, a single flat surface which is simple to keep clean.



**The inner door glass:** can be removed with a few quick movements for cleaning.



**Side lights:** Two opposing side lights increase visibility inside the oven.



**Automatic opening:** some models have Automatic opening door when the cycle is finished which is a perfect solution for handle-less kitchen units as no handle is needed. For safety reasons, the door locks automatically when the machine is in use to avoid it being opened inadvertently.



**Overfill protection:** The special overfill protection shuts down the stove in the presence of overflow of liquids.



**Indication of residual heat:** After the glass ceramic hob is switched off the residual heat indicator shows which of the heating zones still remains hot. When the temperature drops below 60 ° C, the indicator goes out.



**The oven cavity has 5 different cooking levels.**



**Soft close:** all models are equipped with advanced function of smooth closing of the door, which allows the device to close smoothly and quietly.



**Timer:** All ceramic hobs have a timer which automatically ends cooking after a preset time.



**Vapor Clean:** a simple cleaning function using steam to loosen deposits in the oven cavity.



**The capacity indicates the amount of usable space in the oven cavity in litres.**