

# SR364SA



Product Family	Hob
Built-in type	Traditional
Dimensions	60 cm
Power supply	Gas
Type	Gas
EAN code	8017709294526



## Aesthetics



Aesthetic	Classica
Colour	Stainless steel
Finishing	Satin
Material	Stainless Steel
Type of steel	Brushed
Pan stands	Cast iron
Type of control setting	Control knobs
Control knob position	Front
No. of controls	4
Controls colour	Silver
Logo	Embossed
Serigraphy colour	Grey

## Program / Functions

No. of gas cook zones	4
Total no. of cook zones	4

## Options



Worktop Cut-Out	478-482x555-560 mm
-----------------	--------------------

## Technical Features

**UR**

Front-left - Gas - AUX - 1.10 kW

Rear-left - Gas - UR - 3.30 kW

Rear-right - Gas - Semi Rapid - 1.70 kW

Front-right - Gas - Semi Rapid - 1.70 kW

Gas safety valves                      Yes    Automatic Ignition                      Yes

## Accessories included

Cast iron wok support              1

## Electrical Connection

Electrical connection rating (W)	1 W	Frequency (Hz)	50/60 Hz
Voltage (V)	220-240 V	Power supply cable length	120 cm
Type of electric cable installed	Yes, Single phase	Plug	Not present

## Gas Connection



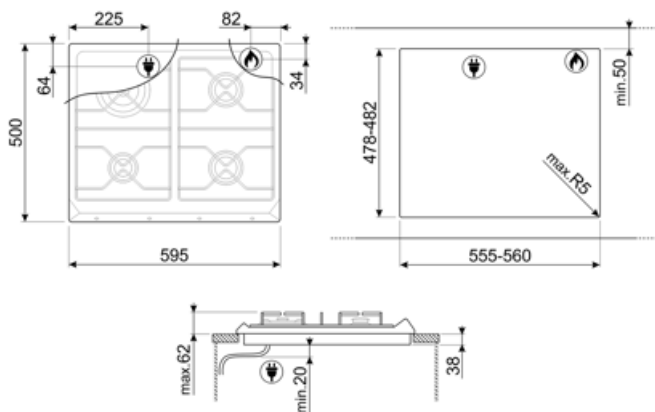

Gas Type	G30 GPL Liquid gas	Other gas connections provided	Conical
Gas connection	Cilindrica	Gas connection rating (W)	7800 W
Other gas nozzles included	G110 City gas, G20 Natural gas		



---

## Symbols glossary

---

- |  |   |   |   |
|--|---|---|---|
|  | Standard installation: Traditional installation in tabletop, suitable for any kitchen sets. |  | Heavy duty cast iron pan stands: for maximum stability and strength.        |
|  | CUT_OUT_STANDARD_72dpi  |  | Ultra rapid burners: Powerful ultra rapid burners offer up to 5kw of power. |
|  | Knobs control   |   |   |