

# SR975XGH



Product Family	Hob
Built-in type	Traditional
Dimensions	70/75 cm
Power supply	Gas
Type	Gas
EAN code	8017709200145



## Aesthetics



Aesthetic	Victoria
Colour	Stainless steel
Finishing	Satin
Material	Stainless Steel
Type of steel	Brushed
Pan stands	Cast iron
Type of control setting	Control knobs
Control knob position	Front
No. of controls	6
Controls colour	Chrome
Logo	Silk screen
Serigraphy colour	Black

## Program / Functions

No. of gas cook zones	5
Total no. of cook zones	5

## Options



Worktop Cut-Out	478-482x555-560 mm
-----------------	--------------------

## Technical Features

**UR**

Front-left - Gas - AUX - 1.10 kW

Rear-left - Gas - Rapid - 2.60 kW

Central - Gas - 2UR (dual) - 5.00 kW

Rear-right - Gas - Semi Rapid - 1.70 kW

Front-right - Gas - Semi Rapid - 1.70 kW

<b>Gas safety valves</b>	Yes	<b>Automatic Ignition</b>	Yes
--------------------------	-----	---------------------------	-----

## Electrical Connection

<b>Electrical connection rating (W)</b>	1 W	<b>Power supply cable length</b>	120 cm
<b>Voltage (V)</b>	220-240 V	<b>Plug</b>	Not present
<b>Frequency (Hz)</b>	50/60 Hz		

## Gas Connection

<b>Gas Type</b>	G20 Natural gas	<b>Other gas connections provided</b>	Conical
<b>Gas connection</b>	Cilindrical	<b>Gas connection rating (W)</b>	11900 W

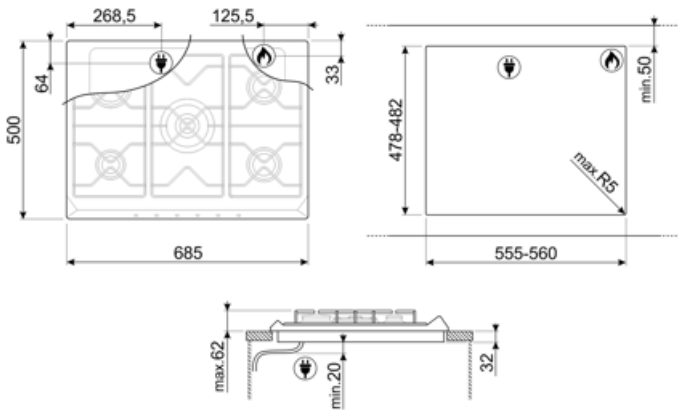

---

## Compatible Accessories

---

### 6MP700AO

Hob knobs set - Cortina Anthracite/Old brass



### 6MP700PO

Hob knobs set - Cortina Cream/Old brass



### GGB70-1

Cast Iron pan stands suitable for 70 cm hobs.



### 6MP700BS

Hob knobs set - Cortina Silver/Silver



### 6MPF2465X

Hob knobs set - Selezione



### GRW

Wok support



---

## Alternative products

---



**SR975PGH**

Colour: Cream



**SR975NGH**

Colour: Black

---

## Symbols glossary

---

- |  |   |   |  |
|--|---|---|--|
|  | Standard installation: Traditional installation in tabletop, suitable for any kitchen sets. |  | Heavy duty cast iron pan stands: for maximum stability and strength. |
|  | Knobs control   |  | CUT_OUT_STANDARD_72dpi   |
|  | Ultra rapid burners: Powerful ultra rapid burners offer up to 5kw of power.                 |   |  |