

SSA91MAX9

Cooker size	90x60 cm
N. of cavities with energy label	1
Cavity heat source	ELECTRICITY
Hob type	Gas
Type of main oven	Thermo-ventilated
Cleaning system main oven	Vapor Clean
EAN code	8017709220877
Energy efficiency class	A



Aesthetics



Aesthetic	Classica	Control knobs	Smeg Classic
Series	Concerto	Controls colour	Stainless steel
Design	Standard	No. of controls	7
Colour	Stainless steel	Serigraphy colour	Black
Finishing	Satin	Display	Electronic 5 buttons
Command panel finish	Stainless steel	Door	With 2 horizontal strips
Logo	Embossed	Glass type	Stopsol
Logo position	Facia below the oven	Handle	Smeg Classic
Upstand	Yes	Handle Colour	Brushed stainless steel
Hob colour	Stainless steel	Storage compartment	Door
Type of pan stands	Cast Iron	Feet	Stainless steel
Type of control setting hob	Control knobs		

Programs / Functions

No. of cooking functions 8

Traditional cooking functions



Static



Fan assisted



Circulaire



Eco



Small grill



Large grill



Fan grill (large)



Fan assisted base

Cleaning functions

 Vapor clean

Hob technical features

 UR

Total no. of cook zones 5

Front left - Gas - Rapid - 2.90 kW

Rear left - Gas - Semi Rapid - 1.80 kW

Central - Gas - UR - 4.00 kW

Rear right - Gas - Semi Rapid - 1.80 kW

Front right - Gas - AUX - 1.00 kW

Type of gas burners Standard

Gas safety valves Yes

Automatic electronic ignition Yes

Burner caps Matt black enamelled

Main Oven Technical Features



Net volume of the cavity 115 l

Gross volume, 1st cavity 129 l

Cavity material Ever Clean enamel

No. of shelves 5

Type of shelves Metal racks

Light type Halogen

Light Power 40 W

Cooking time setting Start and Stop

Light when oven door is open Yes

Door opening Flap down

Removable door Yes

Full glass inner door Yes

Removable inner door Yes

Total no. of door glasses 3

No. of thermo-reflective door glasses 2

Safety Thermostat Yes

Cooling system Tangential

Usable cavity space dimensions (HxWxD) 371x724x418 mm

Temperature control Electro-mechanical

Lower heating element power 1700 W

Upper heating element - Power 1200 W

Grill element 1700 W

Large grill - Power 2900 W

Circular heating element - Power 2 x 1550 W

Grill type Electric

Options Main Oven

Timer Yes

Minimum Temperature 50 °C

End of cooking acoustic alarm Yes

Maximum temperature 260 °C

Accessories included for Main Oven & Hob

Cast iron wok support 1

20mm deep tray 1

Moka stand	1	40mm deep tray	1
Rack with back and side stop	1	Grill mesh	1

Electrical Connection

Plug	Not present	Installed electric cable	Yes, Single phase
Electrical connection rating	3200 W	Power supply cable length	120 cm
Current	14 A	Frequency	50/60 Hz
Voltage	220-240 V	Terminal block	3 poles
Voltage 2 (V)	380-415 V		

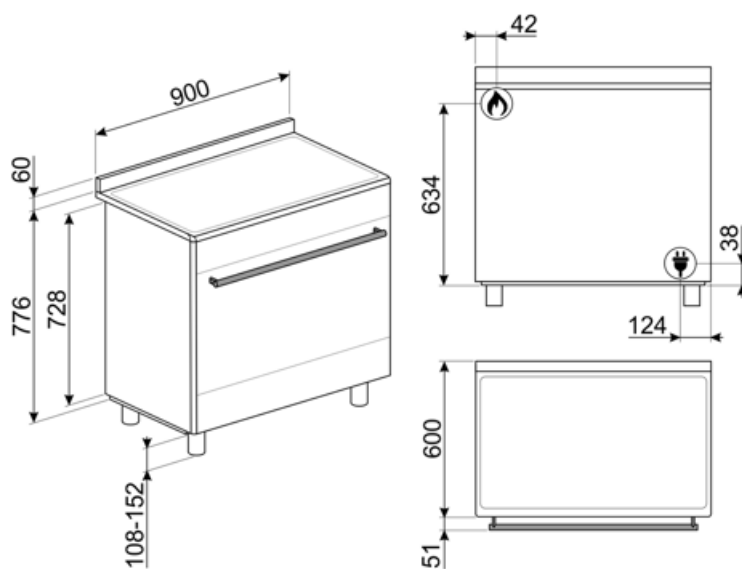

Not included accessories

AIRFRY9

Air fryer rack AIRFRY . Ideal for recreating traditional frying in the oven, but with fewer calories and less fat. It allows you to cook quickly and simply dishes such as French fries, fried vegetables and fish, ensuring perfect browning and crispiness.



BBQ9



GTP

Partially extractable telescopic guides (1 level), suitable for traditional ovens. Made in stainless steel, they guarantee stability and facilitate the smooth extraction of the trays.



KIT600SNL-9

Cover strip for hob back side, depth 60mm, suitable for 90cm single oven Concerto cookers



KITH95

Height extension feet (950mm), stainless steel, suitable for Concerto cookers (911-966mm)



PALPZ

Pizza shovel with folding handle. Dimensions L31.5 x H32.5 cm. Easy and convenient to use and store. Perfect for serving pizza, bread and savory pastries in a safe and professional way.



PPX6090-1

Stainless steel Teppanyaki plate, suitable for Concerto cookers



SFLK1

Child lock



AL90X9

Upstand suitable for 90cm Concerto cookers with gas hob and MF oven



BG6090-1

Cast iron grill plate suitable for Concerto cookers and BM93-BU93



GTT

Totally extractable telescopic guides (1 level), suitable for traditional ovens. Made in stainless steel, they guarantee stability and facilitate the smooth extraction of the trays.



KIT90X9-1

Splashback, stainless steel, 90cm, for Concerto cookers with single MF or gas oven



KITPDQ

Height reduction feet (850mm), stainless steel, for Concerto cookers (850-881mm)



PPR9

Refractory pizza stone without handles. Squared shaped stone: L64xH2,3xP37,5 cm Suitable also for gas ovens, to be put on the griddle.



PRTX

Refractory pizza stone with handles. D=35cm Not suitable for microwave ovens. Suitable for gas ovens, to be put on the griddle.







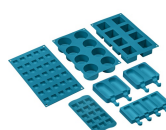



















SMOLD

Set of 7 silicone moulds for ice creams, ice lollies, pralines, ice cubes or to portion food. Usable from -60°C to +230°C



Symbols glossary (TT)

			<p>Heavy duty cast iron pan stands: for maximum stability and strength.</p>
	<p>Installation in column: Installation in column</p>		<p>Air cooling system: to ensure a safe surface temperatures.</p>
	<p>Triple glazed doors: Number of glazed doors.</p>		<p>Ever Clean Enamel: Ever Clean enamel is applied electrostatically, corner to corner and edge to edge to prevent cracking or cracks over time. It is a particular pyrolytic enamel, resistant to acids which, in addition to being pleasantly bright, promotes greater cleaning of the oven walls, thanks to its lower porosity. It is baked at over 850 ° C and slowly polymerized at a scientifically determined rate to ensure uniform depth and strength Ever Clean enamel creates an impeccable finish both on the inside of the oven and on the trays, making the surfaces of the oven incredibly easy to maintain over time as it reduces the adhesion of fat during cooking</p>
	<p>Fan assisted base: the mix of fan and lower heating element alone allows to finish cooking foods already cooked on the surface but not internally more quickly. This system is recommended to finish cooking foods that are already well cooked on the surface, but not internally, which therefore require a moderate higher heat. Ideal for any type of food.</p>		<p>Fan assisted: Intense and homogeneous traditional cooking, also suitable for complex recipes. The fan is active and the heat comes from below and from above at the same time. Ventilated cooking ensures a faster and more homogeneous result, leaving fragrant foods outside and moister inside. Ideal for baked pasta, biscuits, roasts and cobblers.</p>
	<p>Static: Traditional cooking suitable for the preparation of one dish at a time. The fan is not active and the heat comes from below and from above at the same time. Static cooking is slower and more delicate, ideal in order to get well cooked and dry dishes even inside. Ideal for cooking all types of roasts, fatty meats, bread, filled cakes.</p>		<p>Circulaire: it is the perfect function for cooking all types of dishes in a more delicate way. The heat comes from the back of the oven and is distributed quickly and evenly The fan is active. It is also ideal for cooking on multiple levels without mixing smells and flavors.</p>
	<p>ECO: low energy consumption cooking: this function is particularly suitable for cooking on a single shelf with low energy consumption. It is recommended for all types of food except those that can generate a lot of moisture (for example vegetables). To achieve maximum energy savings and reduce time, it is recommended to put the food in the oven without preheating the cooking compartment</p>		<p>Grill: Very intense heat coming only from above from a double heating element. The fan is not active. Provides excellent grilling and gratinating results. Used at the end of cooking, it gives a uniform browning to dishes.</p>
	<p>Half grill: For rapid cooking and browning of foods. Best results can be obtained by using the top shelf for small items, the lower shelves for larger ones, such as chops or sausages. For half grill heat is generated only at the centre of the element, so is ideal for smaller quantities.</p>		<p>Fan grill: very intense heat coming only from above from a double heating element The fan is active. It allows the optimal grilling of thickest meats. Ideal for large cuts of meat.</p>

-
- | | | | |
|--|---|---|--|
|  | Gas ovens offer instantaneous heat control, reduced cooking times and the ability to bake at much lower temperatures than electric ovens. |  | All glass inner door: All glass inner door, a single flat surface which is simple to keep clean. |
|  | The inner door glass: can be removed with a few quick movements for cleaning. |  | Side lights: Two opposing side lights increase visibility inside the oven. |
|  | Automatic opening: some models have Automatic opening door when the cycle is finished which is a perfect solution for handle-less kitchen units as no handle is needed. For safety reasons, the door locks automatically when the machine is in use to avoid it being opened inadvertently. |  | The oven cavity has 5 different cooking levels. |
|  | Ultra rapid burners: Powerful ultra rapid burners offer up to 5kw of power. |  | Vapor Clean: a simple cleaning function using steam to loosen deposits in the oven cavity. |
|  | The capacity indicates the amount of usable space in the oven cavity in litres. |  | Knobs control |

Benefit (TT)

True-convection

The best cooking performances guaranteed by ventilated circular flow

Multiple fans and heating elements guarantee the perfect aerodynamic heat flow, allowing homogeneous and quicker cooking inside the cavity.

Gas hob

Induction offers fast cooking and precise temperature control

Equipped with a thermocouple, the gas supply is cut off if the flame is extinguished for greater safety.

Vapor Clean

By inserting water into a recess at the bottom of the cavity, steam is generated, which softens the residue and facilitates its removal

By inserting water into a recess at the bottom of the cavity, steam is generated, which softens the residue and facilitates its removal.

Isothermic Cavity

The best cooking performance at the highest energy efficiency

Tangential cooling

New cooling system with tangential fan and airflow from the door to the splashback

Multilevel halogen light

Internal halogen lighting on different levels guarantees excellent visibility

Buttons control

Easy and intuitive timer setting with a simple buttons

Adjustable height

Cooker top flushed with the working area thanks to adjustable feet

Removable inner glass

Internal door glasses are easily removable for complete cleaning

Multilevel cooking

Several cooking levels allow maximum flexibility of use

Cold door

During any function, the external door glass is cold, avoiding any risk of burns

AirFry (AIRFRY optional accessory)

Lighter and tastier food thanks to airfry basket (optional accessory)

BBQ (optional accessory)

Barbeque cooking directly in the oven with the double-sided grill (BBQ optional accessory)

Pizza stone (optional accessory)

Baking with refractory stone for soft and crispy pizza and yeast products (STONE optional accessory)

Storage compartment

More space thanks to the lower compartment, ideal for storing accessories or cooking utensils