

# SSA92MAA9

Categorie fornuis	90x60 cm
Aantal ovens met energielabel	1
Cavity heat source	Elektrisch
Type kookplaat	Gemixed
Type primaire oven	Thermogeventileerd
Reinigingssysteem primaire oven	Vapor Clean
EAN-code	8017709221003
Energie-efficiëntieklasse	A



## Design



<b>Esthetiek</b>	Classici	<b>Bedieningsknoppen</b>	Smeg Classici
<b>Series</b>	Concerto	<b>Kleur knoppen</b>	Roestvrij staal
<b>Design</b>	Standaard	<b>Aantal bedieningsknoppen</b>	9
<b>Kleur</b>	Antraciet	<b>Kleur serigrafie</b>	Zilver
<b>Afwerking bedieningspaneel</b>	Gekleurd plaatstaal	<b>Deur</b>	Met 2 horizontale stroken
<b>Logo</b>	Geassembleerd	<b>Type glas</b>	Stopsol
<b>Positie logo</b>	Strook onder de oven	<b>Handgreep</b>	Smeg Classici
<b>Upstand</b>	Ja	<b>Kleur handgreep</b>	Geborsteld roestvrijstaal
<b>Kleur kookplaat</b>	Roestvrij staal	<b>Opbergruimte</b>	Klep
<b>Type pannendragers</b>	Gietijzer	<b>Pootjes</b>	Roestvrij staal
<b>Type bediening</b>	Bedieningsknoppen		

## Programma's / functies

Aantal kookfuncties 8

Traditionele kookfuncties



Statisch



Geventileerd



Circulaire



ECO



Kleine grill

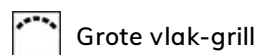

Grote vlak-grill



Fan grill (large)

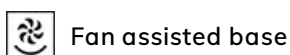

Fan assisted base

## Schoonmaak functie

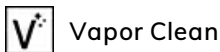

## Technische specificaties kookplaat



**Totaal aantal kookzones** 6

Linksvoor - Gas - URP - 3.50 kW

Linksachter - Gas - SRD - 1.80 kW

Middenvoor - Grillplaat - 1.00 kW - Ø 14.5 cm

Middenachter - Grillplaat - 1.50 kW - Ø 18.0 cm

Rechtsvoor - Gas - SRD - 1.80 kW

Rechtsvoor - Gas - AUX - 1.00 kW

<b>Type gasbranders</b>	Standaard	<b>Thermobeveiliging</b>	Ja
<b>Automatische vonkontsteking</b>	Ja	<b>Branderdeksels</b>	Mat zwart geëmailleerd

## Technische specificaties primaire oven



<b>Netto inhoud</b>	115 l	<b>Aantal ruiten ovendeur</b>	3
<b>Bruto inhoud 1e oven</b>	129 l	<b>Aantal thermo-reflecterende ruiten</b>	2
<b>Materiaal ovenruimte</b>	Ever Clean emaille	<b>Veiligheidsthermostaat</b>	Ja
<b>Aantal kookniveaus</b>	5	<b>Koelsysteem</b>	Mantelkoeling
<b>Type ovenrekken</b>	Metalen zijsteunen	<b>Afmetingen bruikbare interne ovenruimte (hxbxd)</b>	371x724x418 mm
<b>Soort verlichting</b>	Halogeen	<b>Temperatuurregeling</b>	Elektro-mechanisch
<b>Vermogen lamp</b>	40 W	<b>Onderwarmte - vermogen</b>	1700 W
<b>Instelling kooktijd</b>	Start en stop	<b>Bovenwarmte - vermogen</b>	1200 W
<b>Automatische inschakeling verlichting bij openen deur</b>	Ja	<b>Grill - vermogen</b>	1700 W
<b>Deur openen</b>	naar beneden	<b>Grote vlakgrill - vermogen</b>	2900 W
<b>Uitneembare ovendeur</b>	Ja	<b>Circulatie - vermogen</b>	2 x 1550 W
<b>Volledig glazen binnendeur</b>	Ja	<b>Type grill</b>	Elektrisch
<b>Uitneembaar glas binnendeur</b>	Ja		

## Opties primaire oven

<b>Timer</b>	Ja	<b>Minimum temperatuur</b>	50 °C
<b>Akoestisch signaal einde kooktijd</b>	Ja	<b>Maximum temperatuur</b>	260 °C

## Meegeleverde accessoires primaire oven en kookplaat

Gietijzeren wokring	1	Bakplaat (40 mm)	1
Houder t.b.v. caffettiera	1	Inzetrooster	1
Rek met achter- en zijstop	1		

## Elektrische aansluiting

Aansluitwaarde	5700 W	Lengte voedingskabel	115 cm
Stroom	25 A	Type stroomkabel	Double and Three Phase
Spanning	220-240 V	Frequentie	50/60 Hz
Electric cable	Installed, Single phase	Aansluitkast	5 polig

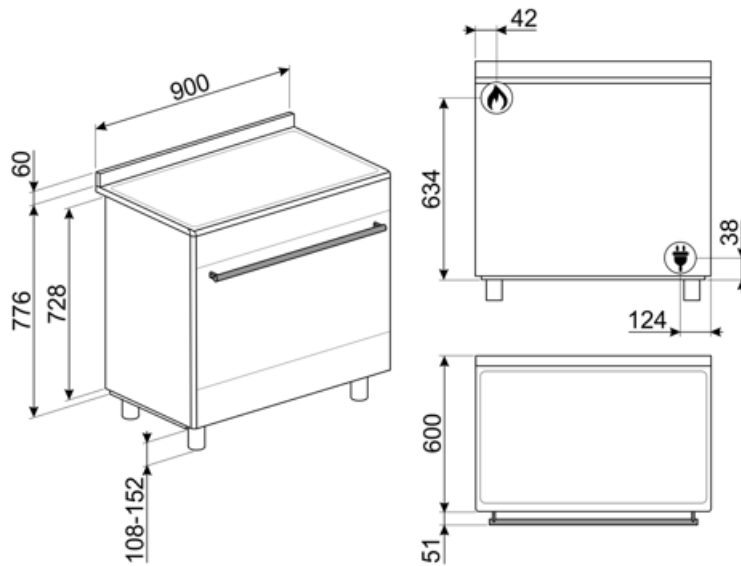

## Accessoires niet inbegrepen

### AIRFRY9

Air fryer rack AIRFRY . Ideal for recreating traditional frying in the oven, but with fewer calories and less fat. It allows you to cook quickly and simply dishes such as French fries, fried vegetables and fish, ensuring perfect browning and crispiness.



### GTP

Gedeeltelijk uittrekbare telescopische geleiders (1 niveau)



### KIT600SNL-9

Cover strip for hob back side, depth 60mm, suitable for 90cm single oven Concerto cookers



### KIT90X9-1

Splashback, stainless steel, 90cm, for Concerto cookers with single MF or gas oven

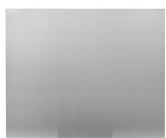

### KITPDQ

Height reduction feet (850mm), stainless steel, for Concerto cookers (850-881mm)



### PPR9

Refractory pizza stone without handles. Squared shaped stone: L64xH2,3xP37,5 cm Suitable also for gas ovens, to be put on the griddle.



### SFLK1

Kinderslot



### BBQ9



### GTT

Volledig uittrekbare telescopische geleiders (1 niveau)



### KIT90N9

Splashback black , 90 cm, suitable for BU & BM cookers



### KITH95

Hoogte uitbreidingsset (min.13cm - max.19,5cm), roestvrij staal

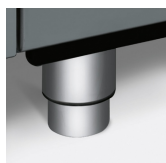

### PALPZ

Pizzaschep met inklapbare handgreep breedte: 315 mm lengte: 325 mm



### PRTX

Ronde pizzasteen met handvaten, diameter 35 cm







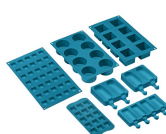

















### SMOLD

Set van 7 siliconen vormpjes voor ijsjes, ijslolly's, pralines, ijsblokjes of om etenswaren te portioneren. Bruikbaar van -60 ° C tot + 230 ° C



## Symbols glossary (TT)

 <p>Heavy duty gietijzeren pannendragers: voor maximale stabiliteit en sterkte.</p>	 <p>A: Droogprestaties van het product, gemeten vanaf A +++ tot D / G afhankelijk van de productfamilie</p>
 <p>Installation in column: Installation in column</p>	 <p>Luchtkoelsysteem: om een veilig oppervlak te garanderen temperaturen.</p>
 <p>Deuren met driedubbele beglazing: aantal glazen deuren.</p>	 <p>Geëmailleerde binnenkant: De geëmailleerde binnenkant van alle Smeg-ovens heeft een speciale antacidumvoering die helpt om de binnenkant schoon te houden door de hoeveelheid kookvet te verminderen.</p>
 <p>Fan assisted base: the mix of fan and lower heating element alone allows to finish cooking foods already cooked on the surface but not internally more quickly. This system is recommended to finish cooking foods that are already well cooked on the surface, but not internally, which therefore require a moderate higher heat. Ideal for any type of food.</p>	 <p>Ventilator met bovenste en onderste elementen: de elementen in combinatie met de ventilator zijn bedoeld om een meer gelijkmatige warmte te bieden, een methode die vergelijkbaar is met conventioneel koken, dus voorverwarmen is vereist. Het meest geschikt voor items die langzaam koken vereisen.</p>
 <p>De ovenruimte wordt tegelijk door het onder- en bovenelement verwarmt. De hitteverdeling over het gerecht is afhankelijk van het niveau waarop men dit plaatst. Geschikt voor bakken op 1 niveau. Gerechten: alle ovenschotels, vlees, gevogelte, brood, (gevulde) taarten. Speciaal: gans en eend (bevatten veel vet).</p>	 <p>Circulaire: it is the perfect function for cooking all types of dishes in a more delicate way. The heat comes from the back of the oven and is distributed quickly and evenly The fan is active. It is also ideal for cooking on multiple levels without mixing smells and flavors.</p>
 <p>ECO: low energy consumption cooking: this function is particularly suitable for cooking on a single shelf with low energy consumption. It is recommended for all types of food except those that can generate a lot of moisture (for example vegetables). To achieve maximum energy savings and reduce time, it is recommended to put the food in the oven without preheating the cooking compartment</p>	 <p>De warmte wordt geproduceerd door het grill- en bovenelement. Verhitting over het volledige oppervlak. De thermostaat wordt, afhankelijk van het gerecht, in de regel op de maximale stand gezet. Bij een korte baktijd kan de ovendeur gesloten blijven; bij langere baktijd blijft deze gedeeltelijk geopend. Voor vleesgerechten (klein- en middelgroot), vleespennen, vis, groenten, gratineren etc.</p>
 <p>De warmte is alleen afkomstig van het grill-element. Verhitting over een kleiner oppervlak. Te gebruiken als de grote vlak-grill, maar voor kleinere hoeveelheden</p>	 <p>Ventilator met grillelement: De ventilator vermindert de felle hitte van de grill en biedt een uitstekende methode om verschillende soorten voedsel, karbonades, steaks, worstjes enz. Te grillen, waardoor het gelijkmatig bruin wordt en de warmte wordt verdeeld, zonder het voedsel uit te drogen. De bovenste twee niveaus die voor gebruik worden aanbevolen, en het onderste deel van de oven kunnen worden gebruikt om gerechten tegelijkertijd warm te houden, een uitstekende mogelijkheid bij het bereiden van een gegrild ontbijt. Halve grill (alleen middengedeelte) is ideaal voor kleine hoeveelheden voedsel.</p>

- 
- |   |   |
|---|---|
|  All glass inner door: All glass inner door, a single flat surface which is simple to keep clean. |  The inner door glass: can be removed with a few quick movements for cleaning.   |
|  verlichting  |  Automatic opening: some models have Automatic opening door when the cycle is finished which is a perfect solution for handle-less kitchen units as no handle is needed. For safety reasons, the door locks automatically when the machine is in use to avoid it being opened inadvertently. |
|  The oven cavity has 5 different cooking levels.  |  Ultrasnelle branders: Krachtige ultrasnelle branders bieden tot 5kw vermogen.   |
|  Vapor Clean: a simple cleaning function using steam to loosen deposits in the oven cavity.       |  The capacity indicates the amount of usable space in the oven cavity in litres.   |
|  Knobs control  |   |

## Benefit (TT)

---

### **True-convection**

The best cooking performances guaranteed by ventilated circular flow

Multiple fans and heating elements guarantee the perfect aerodynamic heat flow, allowing homogeneous and quicker cooking inside the cavity.

### **Vapor Clean**

By inserting water into a recess at the bottom of the cavity, steam is generated, which softens the residue and facilitates its removal

By inserting water into a recess at the bottom of the cavity, steam is generated, which softens the residue and facilitates its removal.

### **Isothermic Cavity**

The best cooking performance at the highest energy efficiency

### **Tangential cooling**

New cooling system with tangential fan and airflow from the door to the splashback

### **Multilevel halogen light**

Internal halogen lighting on different levels guarantees excellent visibility

### **Adjustable height**

Cooker top flushed with the working area thanks to adjustable feet

### **Removable inner glass**

Internal door glasses are easily removable for complete cleaning

### **Multilevel cooking**

Several cooking levels allow maximum flexibility of use

### **Cold door**

During any function, the external door glass is cold, avoiding any risk of burns

### **AirFry (AIRFRY optional accessory)**

Lighter and tastier food thanks to airfry basket (optional accessory)

### **BBQ (optional accessory)**

Barbeque cooking directly in the oven with the double-sided grill (BBQ optional accessory)

### **Pizza stone (optional accessory)**

Baking with refractory stone for soft and crispy pizza and yeast products (STONE optional accessory)

### **Knobs control**

Easy and intuitive timer setting with a elegant knobs

### **Storage compartment**

More space thanks to the lower compartment, ideal for storing accessories or cooking utensils