

# ST211D



Product Family	Dishwashers
Commercial width	60 cm
Commercial height	82 cm
Installation	Fully-integrated built-in
Kitchen panel	Not supplied
N° baskets	2
EAN code	8017709310516



## Programs



N. of programmes	5	ECO	Yes
Washing temperatures	45, 50, 65, 75 °C	Mix	Yes
Crystal	Yes	Hygiene 99,9%	Yes
Full express - 60 minutes	Yes		

## Options



Delay timer option	3-6-9 hours	Extra dry option	Yes
--------------------	-------------	------------------	-----

## Baskets



Basket colour	Grey	Lower Basket	With fixed racks
Basket components colour	Grey	Lower basket with anti-drip inserts	Yes
Upper Basket	With central fixed racks	Largest loadable dish in lower basket	30,0 cm
Glass holder	Yes	Colour Inner Components	Green
Height adjustment of the upper basket	On three levels (5 cm)	Cutlery basket	Yes
Largest loadable dish in upper basket	25,0 cm		

## Technical Features



<b>Width (mm)</b>	598 mm	<b>Max water hardness</b>	90°FH; 50°dH
<b>Depth (mm)</b>	545 mm	<b>Drying system</b>	Natural condenser drying, with Dry Assist + automatic door opening system at the end of the cycle
<b>Product Height (mm)</b>	818 mm	<b>Steam protection</b>	In plastic
<b>Controls</b>	Electronic	<b>Tube material</b>	Stainless steel
<b>Programme graphics</b>	Symbols	<b>Filter</b>	Stainless steel
<b>On/off indicator</b>	Yes	<b>Concealed heating element</b>	Yes
<b>Salt light indicator</b>	Light	<b>Hinges</b>	Self balancing with fixed hinges
<b>Rinse aid indicator</b>	Light	<b>Min. and max. frontal panel weight</b>	2 - 9 kg
<b>End of cycle indicator</b>	Acoustic signal	<b>Min. and max plinth height</b>	100 - 228 mm
<b>Washing system</b>	Orbital	<b>Adjustable feet</b>	7cm, from 820 to 890 mm
<b>Third spray arm</b>	Single	<b>Back cover</b>	Yes
<b>Water softener</b>	With electronic setting	<b>Depth of dishwasher with open door (mm)</b>	1146
<b>Flood protection system</b>	Single Acquastop	<b>Back feet adjustable from front</b>	Yes
<b>Water supply</b>	Single; cold/hot water max. 60°C - energysave with hot water up to 35%	<b>Top cover</b>	In plastic

## Performance / Energy Label - Reg. 2019



<b>Energy Efficiency Class</b>	D	<b>Programme duration</b>	3:35 h:min
<b>Energy consumption [per 100 cycles, based on the eco programme]</b>	84 KWh	<b>Airborne acoustical noise emissions</b>	51 dB(A) re 1 pW
<b>Rated capacity (ps)</b>	13	<b>Airborne acoustical noise emission class</b>	D
<b>Water consumption [per cycle]</b>	12,0 litres	<b>Energy efficiency Index (EEI)</b>	49,9

## Electrical Connection

<b>Plug</b>	(F;E) Schuko	<b>Frequency (Hz)</b>	50 Hz
<b>Connected power</b>	1800 W	<b>Type of connection</b>	Single-phase
<b>Current</b>	10 A	<b>Power supply cable length</b>	140 cm
<b>Voltage</b>	220-240 V		

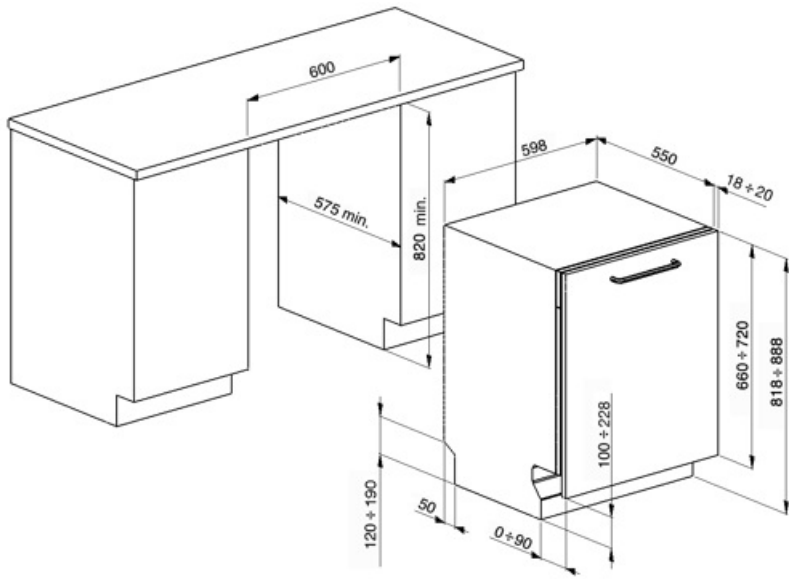

---

## Not included accessories

---



**KIT82CN**



**KIT82CX**

**KITPL60FABB**

Toekick Kit in White colour with adjustable height. Can be fitted over all the fully integrated and underbench models with Fixed Fulcrum. Can be installed also on the models with variable fulcrum or flexifit hinges.



**KITPL60FABX**

Toekick Kit in Stainless Steel with adjustable height. Can be fitted over all the fully integrated and underbench models with Fixed Fulcrum. Can be installed also on the models with variable fulcrum or flexifit hinges.



**KITPL60FABN**

Toekick Kit in Black colour with adjustable height. Can be fitted over all the fully integrated and underbench models with Fixed Fulcrum. Can be installed also on the models with variable fulcrum or flexifit hinges.

















**KITPLV2**

Kit extension for dishwasher and washing machine: lenght mt. 2



## Symbols glossary (TT)

 <p>Acquastop: Some Smeg dishwashers are equipped with a simple Acquastop: float sensor in the bottom which is necessary to prevent an accidental leakage of water inside the appliance.</p>	 <p>To improve the drying of dishes without leaving stains.</p>
 <p>82 cm high</p>	 <p>Delay Timer: Option to postpone the start of the desired programme by up to 24 hours in order to programme the dishwasher to run at the desired time.</p>
 <p>Orbital wash system distributes water evenly throughout the 60cm dishwasher cavity, directing water with precision to ensure an excellent wash.</p>	 <p>Crystals: The Crystals programme is dedicated to delicate dishes such as glasses and china.</p>
 <p>Eco: Eco, this economic wash programme uses a low amount of water and energy in order to provide the most environmentally friendly cleaning option.</p>	 <p>Mix: The Mix programme is suitable for mixed crockery and everyday pots and pans, without any particular incrustation.</p>
 <p>13 place settings: Number of place settings.</p>	 <p>System WaterSave ensures the best washing results with minimal water consumption depending on the model of dishwasher.</p>
 <p>EXTRA DRY This option adds a hot rinse cycle that ensures improved drying.</p>	 <p>Quick wash cycle for normally soiled mixed loads such as dishes and pans, even with dried-on residues. Dishes are washed and dried in 60 minutes.</p>
 <p>Energy efficiency class D</p>	 <p>HYGIENE 99.9% High-temperature washing programme. The 75° rinse guarantees the removal of 99.9% of germs and bacteria.</p>