

ST291D



Product Family	Dishwashers
Commercial width	60 cm
Commercial height	82 cm
Installation	Fully-integrated built-in
Kitchen panel	Not supplied
N° baskets	2
EAN code	8017709306823



Programs



N. of programmes	5	ECO	Yes
Washing temperatures	45, 50, 65, 75 °C	Mix	Yes
Crystal	Yes	Hygiene 99,9%	Yes
Full express - 60 minutes	Yes		

Options



Delay timer option	3-6-9 hours	Extra dry option	Yes
--------------------	-------------	------------------	-----

Baskets



Basket colour	Grey	Lower Basket	With fixed racks
Basket components colour	Grey	Lower basket with anti-drip inserts	Yes
Upper Basket	With central fixed racks	Basket with anti-drip system	Yes
Glass holder	Yes	Largest loadable dish in lower basket	30,0 cm
Height adjustment of the upper basket	On three levels (5 cm)	Colour Inner Components	Green
Largest loadable dish in upper basket	25,0 cm	Cutlery basket	Yes

Technical Features



Width (mm)	598 mm	Max water hardness	100°fH;58°dH
Depth (mm)	545 mm	Drying system	Natural condenser drying, with Dry Assist + automatic door opening system at the end of the cycle
Product Height (mm)	818 mm	Steam protection	In plastic
Controls	Electronic	Tube material	Stainless steel
Programme graphics	Symbols	Filter	Stainless steel
On/off indicator	Yes	Concealed heating element	Yes
Salt light indicator	Light	Hinges	Self balancing with fixed hinges
Rinse aid indicator	Light	Min. and max. frontal panel weight	2 - 9 kg
End of cycle indicator	Acoustic signal	Min. and max plinth height	100 - 228 mm
Washing system	Orbital	Adjustable feet	7cm, from 820 to 890 mm
Third spray arm	Single	Back cover	Yes
Water softener	With electronic setting	Depth of dishwasher with open door (mm)	1168
Flood protection system	Total Acquastop	Back feet adjustable from front	Yes
Water supply	Single; cold/hot water max. 60°C - energysave with hot water up to 35%	Top cover	In plastic

Performance / Energy Label - Reg. 2019



Energy Efficiency Class	D	Programme duration	4:10 h:min
Energy consumption [per 100 cycles, based on the eco programme]	84 KWh	Airborne acoustical noise emissions	49 dB(A) re 1 pW
Rated capacity (ps)	13	Airborne acoustical noise emission class	C
Water consumption [per cycle]	12,0 litres	Energy efficiency Index (EEI)	49,9

Electrical Connection

Plug	(F;E) Schuko	Frequency (Hz)	50 Hz
Connected power	1900 W	Type of connection	Single-phase
Current	10 A	Power supply cable length	140 cm
Voltage	220-230 V		

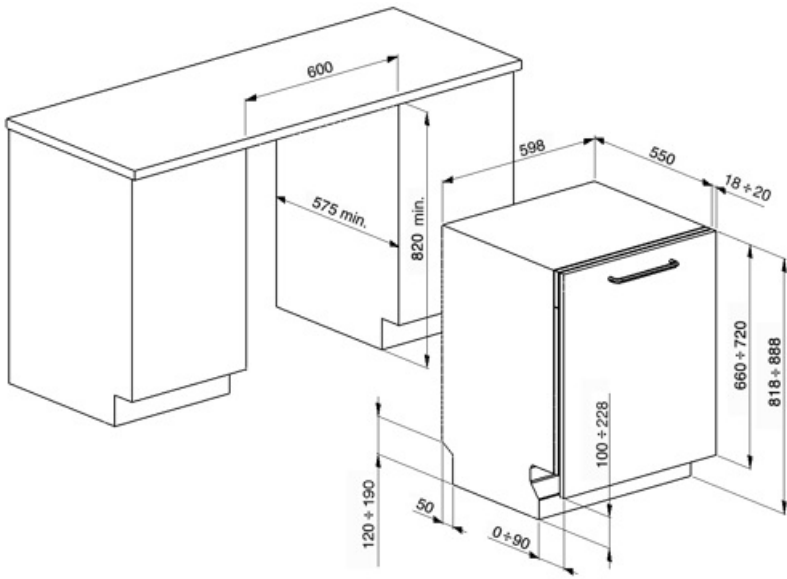

Not included accessories

KITPL60FABB

Toeckick Kit in White colour with adjustable height. Can be fitted over all the fully integrated and underbench models with Fixed Fulcrum. Can be installed also on the models with variable fulcrum or flexifit hinges.



KITPL60FABX

Toeckick Kit in Stainless Steel with adjustable height. Can be fitted over all the fully integrated and underbench models with Fixed Fulcrum. Can be installed also on the models with variable fulcrum or flexifit hinges.



KIT82CX



KITPL60FABN

Toeckick Kit in Black colour with adjustable height. Can be fitted over all the fully integrated and underbench models with Fixed Fulcrum. Can be installed also on the models with variable fulcrum or flexifit hinges.



KITPLV2















Kit extension for dishwasher and washing machine: lenght mt. 2



KIT82CN



Symbols glossary (TT)

 To improve the drying of dishes without leaving stains.	 Energy efficiency class D
 82 cm high	 Delay Timer: Option to postpone the start of the desired programme by up to 24 hours in order to programme the dishwasher to run at the desired time.
 Noise Level: Excellent insulation and special devices keep noise to a minimum.	 Orbital wash system distributes water evenly throughout the 60cm dishwasher cavity, directing water with precision to ensure an excellent wash.
 Crystals: The Crystals programme is dedicated to delicate dishes such as glasses and china.	 Eco: Eco, this economic wash programme uses a low amount of water and energy in order to provide the most environmentally friendly cleaning option.
 Mix: The Mix programme is suitable for mixed crockery and everyday pots and pans, without any particular incrustation.	 13 place settings: Number of place settings.
 Total Acquastop: In addition to the partial Acquastop protection present in all Smeg dishwashers, some models have an electronic device fitted to the water intake hose, which monitors water levels in the machine, detects leaks in the hose and switches off the water supply immediately when necessary.	 System WaterSave ensures the best washing results with minimal water consumption depending on the model of dishwasher.
 EXTRA DRY This option adds a hot rinse cycle that ensures improved drying.	 Quick wash cycle for normally soiled mixed loads such as dishes and pans, even with dried-on residues. Dishes are washed and dried in 60 minutes.
 HYGIENE 99.9% High-temperature washing programme. The 75° rinse guarantees the removal of 99.9% of germs and bacteria.	