

# ST292D



Familie	Vaatwasser
Commerciële breedte	60 cm
Nishoogte	82 cm
Installatie	Volledig geïntegreerd
Deur paneel	Niet meegeleverd
Aantal korven	2
EAN-code	8017709306830



## Programma's / functies



Aantal programma's	10+1	Mix	Ja
Wastemperatuur	38, 45, 50, 55, 65, 70, 75 °C	Stil (-2dB)	Ja
Weken	Ja	Intensief	Ja
Snel 27'	Ja	Zelf reinigen	Ja
Krystal	Ja	Hygiëne 99,9%	Ja
Snel - Volledig 60'	Ja	Delicate vaat	Ja
Eco	Ja		

## Opties



Dry Assist + opties	Ja	FlexiZone ½ (halve beladingsmogelijkheid)	Ja
Delay timer optie	Tot 24 uur, i.c.m. automatisch spoelen	Optie speciale programma's	Ja

## Korven



Kleur korven	Grijs	Maximum afmetingen bord dat in bovenste korf kan worden geladen	25,0 cm
Kleur korfcomponenten	Grijs	Onderkorf	2 inklapbare rekken
Handgreep	Op onder- en bovenkorf		
Bovenkorf	Met vaste rekken		
Glazen houder	Ja		

In hoogte verstelbare bovenkorf 3 niveaus

Onderkorf met anti-drup inserts Ja

Maximum afmetingen bord dat in onderste korf kan worden geladen 30,0 cm

Kleur binnenonderdelen Groen

Bestekmandje Ja

## Technische specificaties



**Breedte product** 598 mm  
**Diepte product** 545 mm  
**Type display** 3 cijfers  
**Hoogte product** 818 mm  
**Bediening** Elektronisch  
**Display** Instelling Delay timer, Programma duur indicator

**Grafische weergave programma's** Symbolen

**Aan/uit indicator** Ja  
**Zout indicator** Indicator (lampje)  
**Glansspoelmiddel indicator** Indicator (lampje)  
**Indicator einde cyclus** Akoestisch signaal  
**Wassysteem** Standaard  
**Derde sproeiarm** Enkel  
**Waterontkalker** Elektronisch instelbaar  
**Overstroombeveiliging** Total Acquastop

**Watertoevoer** Enkel; koud en warm water tot 60°C - energiebesparing tot 35%

**Maximale waterhardheid** 100°fH;58°dH

**Droogstelsysteem** Natuurlijk condensor drogen met Dry Assist + automatische deuropeningssysteem aan het einde van de cyclus

**Stoombeveiliging** Van kunststof

**Materiaal kuip** Roestvrij staal

**Filter** Roestvrij staal

**Verborgen verwarmingselement** Ja

**Scharnieren** Zelfbalancerend met vast steunpunt

**Min. en max. frontaal paneelgewicht** 2 - 9 kg

**Min. en max. plinthoogte** 100 - 228 mm

**Verstelbare voetjes** 7 cm, van 820 tot 890 mm

**Back cover** Ja

**Diepte vaatwasser met open deur (mm)** 1168

**Voetjes achterzijde vanaf de voorkant regelbaar** Ja

**Bovenbedekking** Van kunststof

## Performance / Energy Label - Reg. 2019

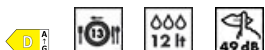

**Energie-efficiëntieklasse (wascyclus)** D

**Energy consumption [per 100 cycles, based on the eco programme]** 84 KWh

**Nominale capaciteit (ps)** 13

**Water verbruik (per cyclus)** 12,0 litres

**Programmaduur** 4:10 h:min

**Geluidsniveau** 49 dB(A) re 1 pW

**Akoestisch geluidsemissieklasse** C

**Energy efficiency Index (EEI)** 49,9

## Elektrische aansluiting

**Stekker** (F;E) Schuko  
**Aansluitwaarde** 1800 W  
**Stroom** 10 A  
**Spanning** 220-240 V

**Frequentie** 50 Hz  
**Type aansluiting** Single-phase  
**Lengte voedingskabel** 140 cm

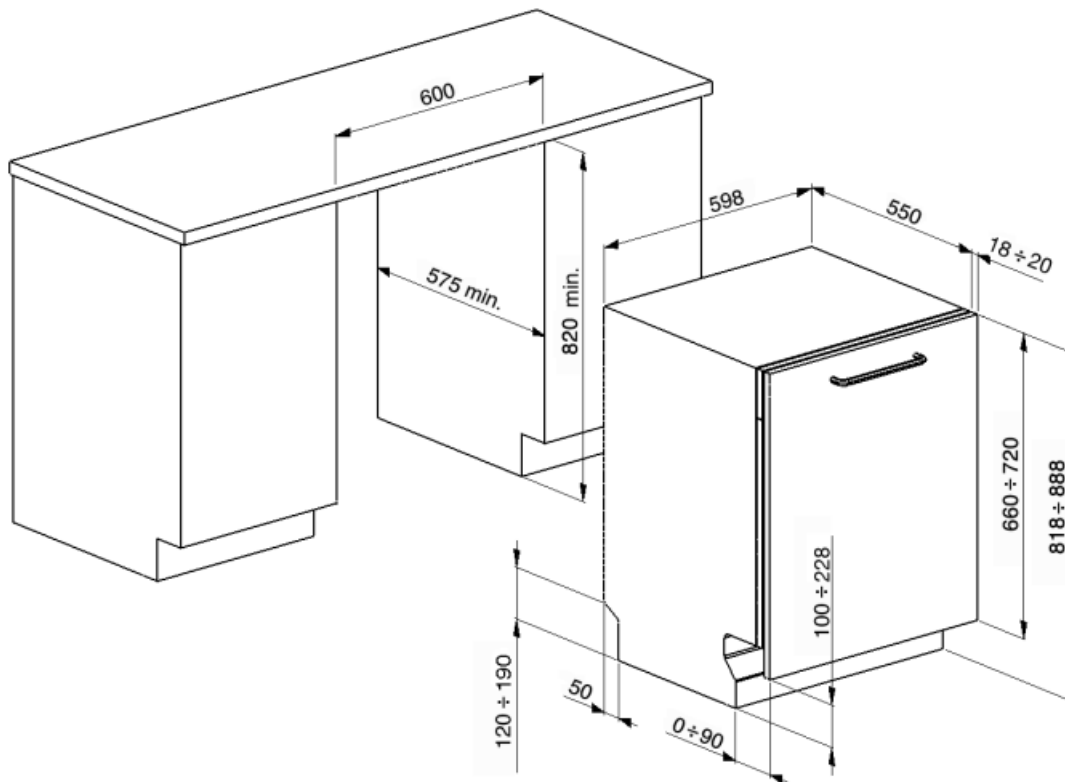

## Accessoires niet inbegrepen

### KITPL60FABB

Kit in witte kleur in hoogte verstelbaar. Kan over alle volledig geïntegreerde en onderbouwmodellen met vast steunpunt worden gemonteerd. Kan ook worden geïnstalleerd op de modellen met variabel draaipunt of flexifit-scharnieren.



### KIT82CX



### KITPLV2

Kit verlengstuk voor vaatwasser en wasmachine: lengte 2 mtr.



### KIT82CN



### KITPL60FABX

Kit in roestvrij staal in hoogte verstelbaar. Kan over alle volledig geïntegreerde en onderbouwmodellen met vast steunpunt worden gemonteerd. Kan ook worden geïnstalleerd op de modellen met variabel draaipunt of flexifit-scharnieren.

### KITPL60FABN

Kit in zwarte kleur in hoogte verstelbaar. Kan over alle volledig geïntegreerde en onderbouwmodellen met vast steunpunt worden gemonteerd. Kan ook worden geïnstalleerd op de modellen met variabel draaipunt of flexifit-scharnieren.







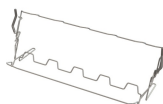

















### KITGH

Kit glazen houder. Deze moet op de eerste mand worden gemonteerd, maar alleen als er inklapbare rekken zijn



## Symbols glossary (TT)

 To improve the drying of dishes without leaving stains.	 Energy efficiency class D
 82 cm high	 Vertragingstimer: De uitgestelde timer kan de start van het programma tot 24 uur uitstellen.
 The Dry Assist + option, in addition to saving energy, ensures perfect drying of the dishes by opening the door automatically at the end of the washing cycle.	 FlexiZone: The ½ load flexizone allows you to wash a reduced load saving energy, water and time and there are no restrictions on where the items are placed.
 Noise Level: Excellent insulation and special devices keep noise to a minimum.	 Crystals: The Crystals programme is dedicated to delicate dishes such as glasses and china.
 Delicate: Delicate washing program is designed for delicate dishes which are not heavily soiled.	 Eco: Eco, this economic wash programme uses a low amount of water and energy in order to provide the most environmentally friendly cleaning option.
 Mix: The Mix programme is suitable for mixed crockery and everyday pots and pans, without any particular incrustation.	 Soak programme: The soak programme provides a rinse to prevent dirt from drying.
 Express 27': The Express 27' programme is a quick wash cycle, at low temperatures, for lightly soiled dishes.	 Ultraclean: The Ultraclean option performs a final rinse at a high temperature of 70°C eliminating virtually all bacteria.
 13 place settings: Number of place settings.	 Total Acquastop: In addition to the partial Acquastop protection present in all Smeg dishwashers, some models have an electronic device fitted to the water intake hose, which monitors water levels in the machine, detects leaks in the hose and switches off the water supply immediately when necessary.
 System WaterSave ensures the best washing results with minimal water consumption depending on the model of dishwasher.	 Quick wash cycle for normally soiled mixed loads such as dishes and pans, even with dried-on residues. Dishes are washed and dried in 60 minutes.
 Dishwasher cleaning cycle. The cycle should be started with the machine empty, without dishes. It is recommended to run the program every 2-3 months, using special dishwasher detergents.	 SILENT: Wash cycle suitable for normally soiled dishes, even with dried-on residues. Ensures maximum noise reduction and is therefore ideal if you wish to run it during the night.
 Allows you to enable additional programs when selected together with any wash cycle. After having selected the required wash cycle, press the button (	 HYGIENE 99.9% High-temperature washing programme. The 75° rinse guarantees the removal of 99.9% of germs and bacteria.