

ST311CS



Product Family	Dishwashers
Commercial width	60 cm
Commercial height	82 cm
Installation	Fully-integrated built-in
Kitchen panel	Not supplied
N° baskets	3, Flexi
EAN code	8017709306854



Programs



N. of programmes	5	Mix	Yes
Washing temperatures	50, 65, 70 °C	Intense	Yes
Soak	Yes	1/2 load	Yes
ECO	Yes		

Options



Delay timer option	3-6-9 hours	Extra dry option	Yes
--------------------	-------------	------------------	-----

Baskets



Basket colour	Grey	Largest loadable dish in upper basket	19,0 cm
Basket components colour	Grey	Lower Basket	With fixed racks
Handle	In plastic on upper and lower basket	Lower basket with anti-drip inserts	Yes
Upper Basket	With central fixed racks	Largest loadable dish in lower basket	30,0 cm
Glass holder	Yes	Colour Inner Components	Green
Height adjustment of the upper basket	On three levels (5 cm)		

Technical Features



Width (mm)	598 mm	Drying system	Natural condenser drying, with Dry Assist + automatic door opening system at the end of the cycle
Depth (mm)	545 mm	Steam protection	In plastic
Product Height (mm)	818 mm	Tube material	Stainless steel
Controls	Electronic	Filter	Stainless steel
Programme graphics	Symbols	Concealed heating element	Yes
Salt light indicator	Light	Hinges	Self balancing with fixed hinges
Rinse aid indicator	Light	Min. and max. frontal panel weight	2 - 9 kg
End of cycle indicator	Acoustic signal	Min. and max plinth height	100 - 228 mm
Washing system	Standard	Adjustable feet	7cm, from 820 to 890 mm
Third spray arm	Single	Back cover	Yes
Water softener	With electronic setting	Depth of dishwasher with open door (mm)	1146
Flood protection system	Single Acquastop	Back feet adjustable from front	Yes
Water supply	Single; cold/hot water max. 60°C - energysave with hot water up to 35%	Top cover	In plastic
Max water hardness	100°FH;58°dH		

Performance / Energy Label - Reg. 2019



Energy Efficiency Class	C	Programme duration	3:35 h:min
Energy consumption [per 100 cycles, based on the eco programme]	73 kWh	Airborne acoustical noise emissions	51 dB(A) re 1 pW
Rated capacity (ps)	13	Airborne acoustical noise emission class	D
Water consumption [per cycle]	12,0 litres	Energy efficiency Index (EEI)	43,8

Electrical Connection

Plug	(F;E) Schuko	Frequency (Hz)	50 Hz
Connected power	1800 W	Type of connection	Single-phase
Current	10 A	Power supply cable length	140 cm
Voltage	220-240 V		

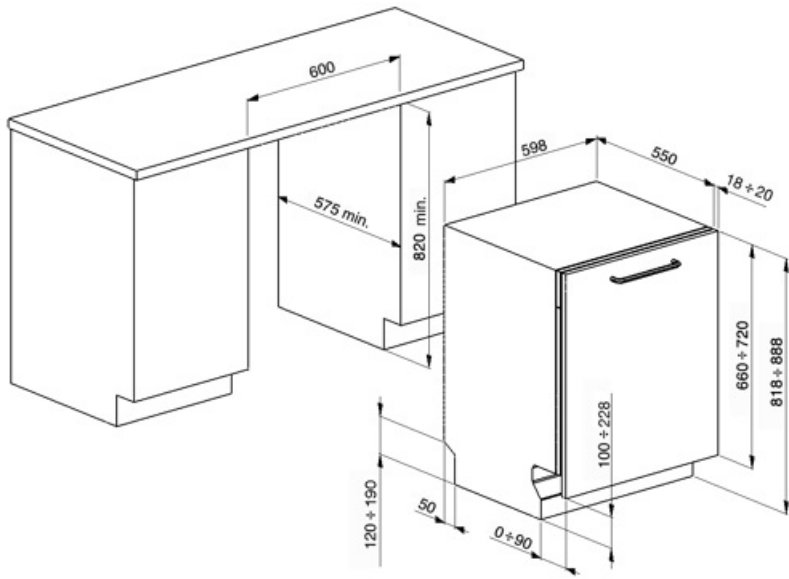

Not included accessories

KITPL60FABB

Toeckick Kit in White colour with adjustable height. Can be fitted over all the fully integrated and underbench models with Fixed Fulcrum. Can be installed also on the models with variable fulcrum or flexifit hinges.



KITPL60FABX

Toeckick Kit in Stainless Steel with adjustable height. Can be fitted over all the fully integrated and underbench models with Fixed Fulcrum. Can be installed also on the models with variable fulcrum or flexifit hinges.



KIT82CX



KITPL60FABN

Toeckick Kit in Black colour with adjustable height. Can be fitted over all the fully integrated and underbench models with Fixed Fulcrum. Can be installed also on the models with variable fulcrum or flexifit hinges.



KITPLV2













Kit extension for dishwasher and washing machine: lenght mt. 2



KIT82CN



Symbols glossary (TT)

	Acquastop: Some Smeg dishwashers are equipped with a simple Acquastop: float sensor in the bottom which is necessary to prevent an accidental leakage of water inside the appliance.		To improve the drying of dishes without leaving stains.
	82 cm high		Delay Timer: Option to postpone the start of the desired programme by up to 24 hours in order to programme the dishwasher to run at the desired time.
	1/2 load: This program is designed for washing dishes not heavily soiled with partial load of the dishwasher.		Eco: Eco, this economic wash programme uses a low amount of water and energy in order to provide the most environmentally friendly cleaning option.
	Mix: The Mix programme is suitable for mixed crockery and everyday pots and pans, without any particular incrustation.		Soak programme: The soak programme provides a rinse to prevent dirt from drying.
	Ultraclean: The Ultraclean option performs a final rinse at a high temperature of 70°C eliminating virtually all bacteria.		13 place settings: Number of place settings.
	System WaterSave ensures the best washing results with minimal water consumption depending on the model of dishwasher.		EXTRA DRY This option adds a hot rinse cycle that ensures improved drying.
	Energy efficiency class C		