

# ST323PT

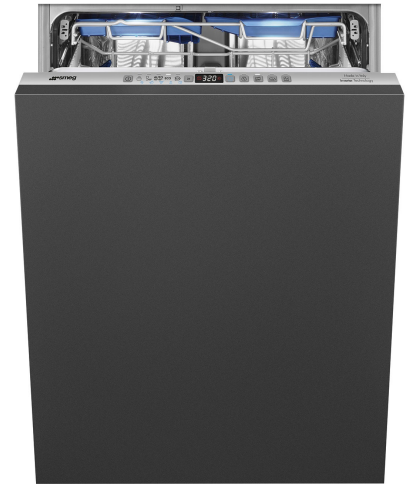

<b>Product Family</b>	Dishwashers
<b>Commercial width</b>	60 cm
<b>Commercial height</b>	82 cm
<b>Installation</b>	Fully-integrated built-in
<b>Kitchen panel</b>	Not supplied
<b>N° baskets</b>	3, FlexiDuo
<b>Motor</b>	Inverter 2.0
<b>Type</b>	Semi professional
<b>EAN code</b>	8017709305086



## Programs



<b>N. of programmes</b>	10+1	<b>Auto sensor 45-65</b>	Yes
<b>Washing temperatures</b>	45, 50, 65, 70, 75 °C	<b>Mix</b>	Yes
<b>Soak</b>	Yes	<b>Intense</b>	Yes
<b>Crystal</b>	Yes	<b>Self clean</b>	Yes
<b>Full express - 60 minutes</b>	Yes	<b>Hygiene 99,9%</b>	Yes
<b>ECO</b>	Yes	<b>Ultra Express</b>	Yes

## Professional programs



<b>Ultra rapid</b>	Yes	<b>Full express PRO</b>	Yes
<b>Mix PRO</b>	Yes	<b>Crystal Pro</b>	Yes
<b>Intensive Pro</b>	Yes		

## Options

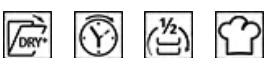

<b>Dry Assist+ option</b>	Yes	<b>Professional option</b>	Yes
<b>Delay timer option</b>	Up to 24 hours	<b>Intensive wash zone option</b>	
<b>1/2 load FlexiZone option</b>	Yes		

## Baskets



<b>Basket colour</b>	Grey	<b>Sliding Guides Extra Glide</b>	Yes
<b>Basket components colour</b>	Grey	<b>Largest loadable dish in upper basket</b>	19,0 cm
<b>Handle</b>	In plastic with stainless steel insert on upper and lower basket	<b>Lower Basket</b>	With 4 foldable racks
<b>Upper Basket</b>	With 3 foldable racks	<b>Lower basket with anti-drip inserts</b>	Yes
<b>Glass holder</b>	Yes	<b>Largest loadable dish in lower basket</b>	30,0 cm
<b>Height adjustment of the upper basket</b>	On three levels (5 cm)	<b>Colour Inner Components</b>	Blue

## Technical Features



<b>Width (mm)</b>	598 mm	<b>Water supply</b>	Single; cold/hot water max. 60°C - energysave with hot water up to 35%
<b>Depth (mm)</b>	545 mm	<b>Max water hardness</b>	100°FH;58°DH
<b>Display type</b>	LED display (3 digit)	<b>Drying system</b>	Natural condenser drying, with Dry Assist + automatic door opening system at the end of the cycle
<b>Product Height (mm)</b>	818 mm	<b>Steam protection</b>	In plastic
<b>Controls</b>	Electronic	<b>Internal light</b>	With White led
<b>Display</b>	Delayed start, Programme time indicator	<b>Tub material</b>	Stainless steel
<b>Programme graphics</b>	Symbols	<b>Filter</b>	Stainless steel
<b>On/off indicator</b>	Yes	<b>Concealed heating element</b>	Yes
<b>Salt light indicator</b>	Light	<b>Hinges</b>	Self balancing, Sliding, FLEXIFIT
<b>Rinse aid indicator</b>	Light	<b>Min. and max. frontal panel weight</b>	2,5 - 11 kg
<b>End of cycle indicator</b>	ActiveLight	<b>Min. and max plinth height</b>	50 - 215 mm
<b>Auto switch-off</b>	Yes	<b>Adjustable feet</b>	7 cm, from 820 to 890 mm
<b>Washing system</b>	Planetarium	<b>Additional gaskets</b>	Yes, with stainless steel plate
<b>Third spray arm</b>	Single	<b>Back cover</b>	Yes
<b>Water softener</b>	With electronic setting	<b>Depth of dishwasher with open door (mm)</b>	1146 mm
<b>Turbidity sensor Aquatest</b>	Yes	<b>Back feet adjustable from front</b>	Yes
<b>Flood protection system</b>	Total Acquastop	<b>Top cover</b>	In plastic

## Performance / Energy Label - Reg. 2019



<b>Energy Efficiency Class</b>	C	<b>Programme duration</b>	4:25 h:min
<b>Energy consumption [per 100 cycles, based on the eco programme]</b>	75 kWh	<b>Airborne acoustical noise emissions</b>	42 dB(A) re 1 pW
<b>Rated capacity (ps)</b>	14	<b>Airborne acoustical noise emission class</b>	B
<b>Water consumption [per cycle]</b>	10.5 litres	<b>Energy efficiency Index (EEI)</b>	43.8

## Electrical Connection

<b>Connected power</b>	5450 W	<b>Type of connection</b>	Three-phase
<b>Current</b>	16 A	<b>Power supply cable length</b>	200 cm
<b>Voltage</b>	400-415 V	<b>Plug</b>	Not present
<b>Frequency (Hz)</b>	50 Hz		

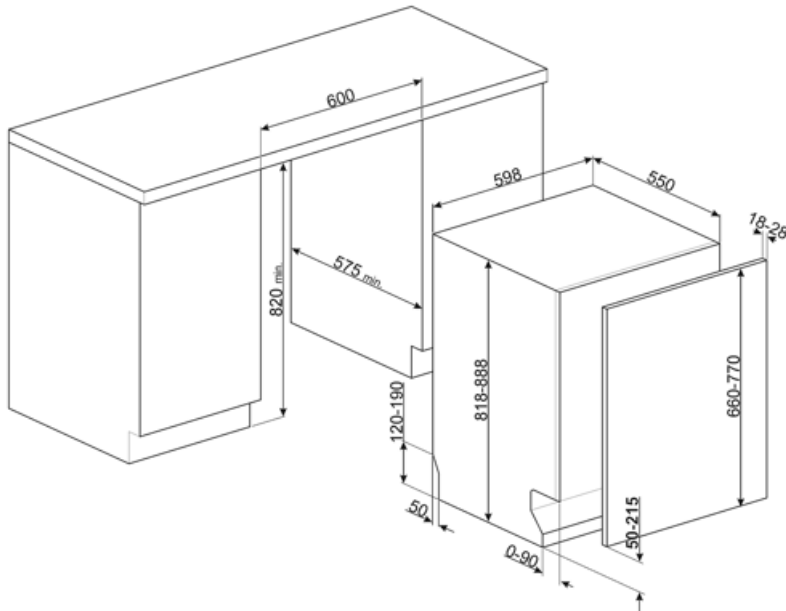

## Compatible Accessories



**KIT82CN**



**KIT82CX**



**KIT82SPRAN**



**KIT82SPRMW**



**KIT82SPRX**



**KITFLEXI**

Kit for 60cm dishwashers with FlexiFit hinges for door panel weight >11 kg (max 15 kg 82 cm and 13,5 kg 86 cm)



**KITGH**

Kit glass holder. It has to be fitted on the first basket but only if there are foldable racks



**KITPL60B**

Toe-kick Kit in White colour with adjustable height and deepness. Can be installed over all the fully integrated and underbench models with variable fulcrum or flexifit hinges.



**KITPL60N**

Toe-kick Kit in Black colour with adjustable height and deepness. Can be installed over all the fully integrated and underbench models with variable fulcrum or flexifit hinges.



**KITPL60X**























Toe-kick Kit in Stainless Steel with adjustable height and deepness. Can be fitted over all the fully integrated and underbench models with variable fulcrum or flexifit hinges.













**KITPLV2**

Kit extension for dishwasher and washing machine: lenght mt. 2

## Symbols glossary

	<p>Activelight is an led light which projects a red spot onto the floor beneath the dishwasher when the appliance is in use.</p>		<p>The Aquatest sensor is an electronic sensor that measures the degree of water transparency at the end of the initial soaking phase. Based on the values measured, the sensor sets the most suitable programme, thus obtaining the best washing results with the minimum amount of water.</p>
	<p>To improve the drying of dishes without leaving stains.</p>		<p>82 cm high</p>
	<p>Delay Timer: Option to postpone the start of the desired programme by up to 24 hours in order to programme the dishwasher to run at the desired time.</p>		<p>FlexiDuo: The FlexiDuo 3rd cutlery basket allows you to arrange cutlery or small cups, ladles, or bulky utensils however you like: it consists of two separate and moveable modules.</p>
	<p>The FlexiFit hinges allow the kitchen panel to slide over the dishwasher door, allowing a minimum kitchen plinth height of 5 cm.</p>		<p>FlexiZone: The ½ load flexizone allows you to wash a reduced load saving energy, water and time and there are no restrictions on where the items are placed.</p>
	<p>The ExtraGlide guides system makes the second basket run even smoother and softer. It facilitates movement even when fully loaded, and thanks to the increased excursion, facilitates the insertion of dishes into the basket.</p>		<p>Noise Level: Excellent insulation and special devices keep noise to a minimum.</p>
	<p>Noise Level: Excellent insulation and special devices keep noise to a minimum.</p>		<p>The Planetarium washing system, with high rotations per minute, guarantees complete coverage of the tank, thanks to the simultaneous rotation of base and sprayers, and excellent washing results.</p>
	<p>Auto 45°- 65°: The auto programme regulates the length of a cycle depending on the need for a pre-wash and the number of rinses required.</p>		<p>Crystals: The Crystals programme is dedicated to delicate dishes such as glasses and china.</p>
	<p>Eco: Eco, this economic wash programme uses a low amount of water and energy in order to provide the most environmentally friendly cleaning option.</p>		<p>IntensivoProf: The Intensive program is recommended for heavily soiled pots and pans and dry residues to be washed quickly.</p>
	<p>Mix: The Mix programme is suitable for mixed crockery and everyday pots and pans, without any particular incrustation.</p>		<p>Soak programme: The soak programme provides a rinse to prevent dirt from drying.</p>
	<p>Ultra Rapid: The program is specifically for Ultra Fast wash very quickly (16 min.). Pots and pans very dirty, even with dried residues.</p>		<p>Ultraclean: The Ultraclean option performs a final rinse at a high temperature of 70°C eliminating virtually all bacteria.</p>
	<p>Professional: Option Professional enables to convert household appliances into semiprofessional ones due to the programs which significantly reduce washing time to obtain an astonishing 16 minutes cycle.</p>		<p>Quick Time: The Quick Time option can reduce the length of the wash cycle up to 55%.</p>

-  14 place settings: Number of place settings.
-  System WaterSave ensures the best washing results with minimal water consumption depending on the model of dishwasher.
-  Dishwasher cleaning cycle. The cycle should be started with the machine empty, without dishes. It is recommended to run the program every 2-3 months, using special dishwasher detergents.
-  The Dry Assist + option, in addition to saving energy, ensures perfect drying of the dishes by opening the door automatically at the end of the washing cycle.
-  HYGIENE 99.9% High-temperature washing programme. The 75° rinse guarantees the removal of 99.9% of germs and bacteria.
-  Total Acquastop: In addition to the partial Acquastop protection present in all Smeg dishwashers, some models have an electronic device fitted to the water intake hose, which monitors water levels in the machine, detects leaks in the hose and switches off the water supply immediately when necessary.
-  Quick wash cycle for normally soiled mixed loads such as dishes and pans, even with dried-on residues. Dishes are washed and dried in 60 minutes.
-  Special quick program for washing glasses.
-  Energy efficiency class C
-  The work aimed at continuous improvement has allowed the creation of the second generation of the Inverter motor 2.0, characterised by greater efficiency and durability over time, which allows very high performance and a lower energy consumption and noise level.

---

## Benefit (TT)

---

### FlexiZone half-load option

Save water and energy with the FlexiZone Half Load option, which optimizes wash performance by adjusting water and energy consumption when washing smaller loads.

### DELAY START

Improved flexibility and convenience with the Delay Start option, which allows cycles to be scheduled up to 24 hours in advance.

### Active Light

Maximum control thanks to the light projected on the floor that indicates when the dishwasher is running and when the cycle is complete

Smeg dishwashers equipped with ActiveLight signal the appliance's activity status by projecting a light on the floor while the cycle is running. The light goes out at the end of the cycle, signalling that the dishwasher can be unloaded.

### FlexiDuo

The flexible third basket provides additional space, adapting to the load to accommodate various types of dishes, ensuring optimal organization and efficient use of interior capacity

The third FlexiDuo basket consists of two separate sections that can be handled independently of each other, stacked and/or removed, offering loading flexibility for every need. Depending on the arrangement, it allows cups, tall glasses, bulky utensils and pots and pans to be placed in the upper basket.

### Planetarium Wash System

Full and deep wash coverage thanks to the advanced movement of the spray arm, an innovation patented by Smeg

Smeg's patented Planetarium Wash System guarantees impeccable cleaning. With a simultaneous double movement of the sprayer and 65 rotations per minute, it reaches every nook and cranny for extraordinary results. Dishes, glasses and utensils will be perfectly clean in no time. An intelligent system where efficiency and style meet, delivering brilliant results effortlessly.

### Turbidity sensor Aquatest

Enhanced energy efficiency and improved cleaning performance thanks to the AquaTest turbidity sensor, which detects water clarity and helps optimize the wash cycle

### Flood protection system

Enhanced protection and peace of mind with Total Aqua Stop, an advanced leak detection system that automatically shuts off the water supply if a leak is detected beneath the drum or within the water intake hose.

### Flexifit hinge system

Smooth-running door for optimal integration into the kitchen design

The height of the plinth can vary from 5 cm to 21.5 cm, allowing it to fit perfectly into the cabinet. Thanks to this solution, the dishwasher blends harmoniously into its surroundings, with the door and plinth perfectly aligned with the other kitchen furniture.

---

## Extra Glide Telescopic Guides

Smoother and more stable loading and unloading operations

Extra Glide telescopic guides ensure smooth and safe extraction of the upper basket, even with heavy loads. The telescopic design ensures smooth, stable and silent movement, improving ergonomics and convenience. Ideal for optimising space and ease of use, they combine durability and comfort in every washing operation.

## DryAssist+

The Dry Assist+ system of automatic door opening at the end of the cycle ensures fast and energy-efficient drying