

ST382C



Product Family	Dishwashers
Commercial width	60 cm
Commercial height	82 cm
Installation	Fully-integrated built-in
Kitchen panel	Not supplied
N° baskets	3, Flexi
EAN code	8017709306861



Programs



N. of programmes	10+1	Mix	Yes
Washing temperatures	38, 45, 50, 55, 65, 70, 75 °C	Quiet (~2 dB)	Yes
Soak	Yes	Intense	Yes
Express 27'	Yes	Self clean	Yes
Crystal	Yes	Hygiene 99,9%	Yes
Full express - 60 minutes	Yes	Delicate	Yes
ECO	Yes		

Options

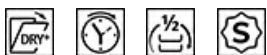

Dry Assist+ option	Yes	1/2 load FlexiZone option	Yes
Delay timer option	Up to 24 hours	Special programs option	Yes

Baskets



Basket colour	Grey	Largest loadable dish in upper basket	19,0 cm
Basket components colour	Grey	Lower Basket	With 2 foldable racks
Handle	In plastic on upper and lower basket	Lower basket with anti-drip inserts	Yes

Upper Basket	With central fixed racks	Largest loadable dish in lower basket	30,0 cm
Glass holder	Yes	Colour Inner Components	Green
Height adjustment of the upper basket	On three levels (5 cm)		

Technical Features



Width (mm)	598 mm	Max water hardness	100°fH;58°dH
Depth (mm)	545 mm	Drying system	Natural condenser drying, with Dry Assist + automatic door opening system at the end of the cycle
Display type	LED display	Steam protection	In plastic
Product Height (mm)	818 mm	Tube material	Stainless steel
Controls	Electronic	Filter	Stainless steel
Display	Delayed start, Programme time indicator	Concealed heating element	Yes
Programme graphics	Symbols	Hinges	Self balancing with fixed hinges
Salt light indicator	Light	Min. and max. frontal panel weight	2 - 9 kg
Rinse aid indicator	Light	Min. and max plinth height	100 - 228 mm
End of cycle indicator	Acoustic signal	Adjustable feet	7cm, from 820 to 890 mm
Washing system	Standard	Back cover	Yes
Third spray arm	Single	Depth of dishwasher with open door (mm)	1146
Water softener	With electronic setting	Back feet adjustable from front	Yes
Flood protection system	Total Acquastop	Top cover	In plastic
Water supply	Single; cold/hot water max. 60°C - energysave with hot water up to 35%		

Performance / Energy Label - Reg. 2019



Energy Efficiency Class	C	Programme duration	4:10 h:min
Energy consumption [per 100 cycles, based on the eco programme]	73 KWh	Airborne acoustical noise emissions	48 dB(A) re 1 pW
Rated capacity (ps)	13	Airborne acoustical noise emission class	C
Water consumption [per cycle]	12,0 litres	Energy efficiency Index (EEI)	43,8

Electrical Connection

Plug	(F;E) Schuko	Frequency (Hz)	50 Hz
Connected power	1800 W	Type of connection	Single-phase
Current	10 A	Power supply cable length	140 cm
Voltage	220-240 V		

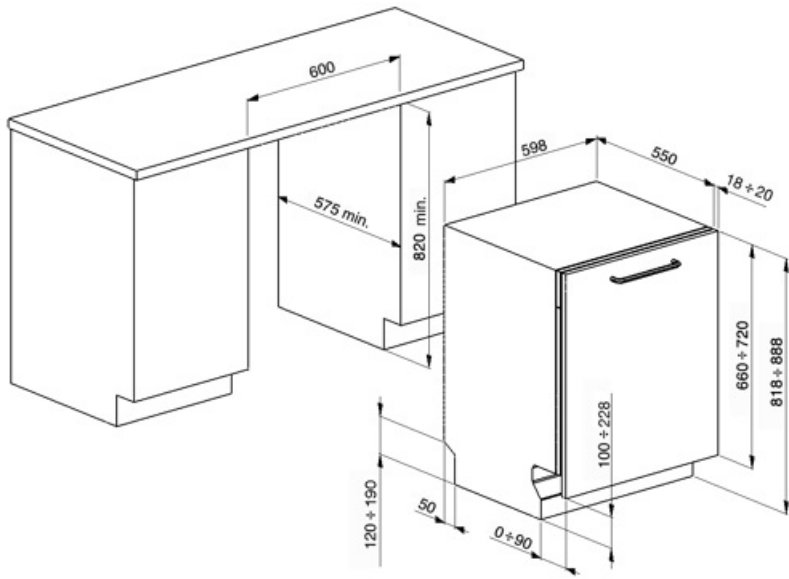

Compatible Accessories



KIT82CN



KIT82CX

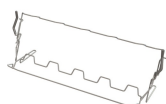

KITGH

Kit glass holder. It has to be fitted on the first basket but only if there are foldable racks



KITPL60FABB

Toe kick Kit in White colour with adjustable height. Can be fitted over all the fully integrated and underbench models with Fixed Fulcrum. Can be installed also on the models with variable fulcrum or flexifit hinges.



KITPL60FABN

Toe kick Kit in Black colour with adjustable height. Can be fitted over all the fully integrated and underbench models with Fixed Fulcrum. Can be installed also on the models with variable fulcrum or flexifit hinges.



KITPL60FABX























Toe kick Kit in Stainless Steel with adjustable height. Can be fitted over all the fully integrated and underbench models with Fixed Fulcrum. Can be installed also on the models with variable fulcrum or flexifit hinges.



KITPLV2

Kit extension for dishwasher and washing machine: lenght mt. 2

Symbols glossary

 To improve the drying of dishes without leaving stains.	 82 cm high
 Delay Timer: Option to postpone the start of the desired programme by up to 24 hours in order to programme the dishwasher to run at the desired time.	 FlexiZone: The ½ load flexizone allows you to wash a reduced load saving energy, water and time and there are no restrictions on where the items are placed.
 Noise Level: Excellent insulation and special devices keep noise to a minimum.	 Crystals: The Crystals programme is dedicated to delicate dishes such as glasses and china.
 Delicate: Delicate washing program is designed for delicate dishes which are not heavily soiled.	 Eco: Eco, this economic wash programme uses a low amount of water and energy in order to provide the most environmentally friendly cleaning option.
 Mix: The Mix programme is suitable for mixed crockery and everyday pots and pans, without any particular incrustation.	 Soak programme: The soak programme provides a rinse to prevent dirt from drying.
 Express 27': The Express 27' programme is a quick wash cycle, at low temperatures, for lightly soiled dishes.	 Ultraclean: The Ultraclean option performs a final rinse at a high temperature of 70°C eliminating virtually all bacteria.
 13 place settings: Number of place settings.	 Total Acquastop: In addition to the partial Acquastop protection present in all Smeg dishwashers, some models have an electronic device fitted to the water intake hose, which monitors water levels in the machine, detects leaks in the hose and switches off the water supply immediately when necessary.
 System WaterSave ensures the best washing results with minimal water consumption depending on the model of dishwasher.	 Quick wash cycle for normally soiled mixed loads such as dishes and pans, even with dried-on residues. Dishes are washed and dried in 60 minutes.
 Dishwasher cleaning cycle. The cycle should be started with the machine empty, without dishes. It is recommended to run the program every 2-3 months, using special dishwasher detergents.	 SILENT: Wash cycle suitable for normally soiled dishes, even with dried-on residues. Ensures maximum noise reduction and is therefore ideal if you wish to run it during the night.
 Allows you to enable additional programs when selected together with any wash cycle. After having selected the required wash cycle, press the button ( The Dry Assist + option, in addition to saving energy, ensures perfect drying of the dishes by opening the door automatically at the end of the washing cycle.
 Energy efficiency class C	 HYGIENE 99.9% High-temperature washing programme. The 75° rinse guarantees the removal of 99.9% of germs and bacteria.



The work aimed at continuous improvement has allowed the creation of the second generation of the Inverter motor 2.0, characterised by greater efficiency and durability over time, which allows very high performance and a lower energy consumption and noise level.

Benefit (TT)

DryAssist+

The Dry Assist+ system of automatic door opening at the end of the cycle ensures fast and energy-efficient drying