

ST382C



Familie	Vaatwasser
Commerciële breedte	60 cm
Nishoogte	82 cm
Installatie	Volledig geïntegreerd
Deur paneel	Niet meegeleverd
Aantal korven	3, Flexi
Motor	Inverter 2.0
EAN-code	8017709306861



Programs



Aantal programma's	10+1	Mix	Ja
Wastemperatuur	38, 45, 50, 55, 65, 70, 75 °C	Stil (-2dB)	Ja
Weken	Ja	Intensief	Ja
Snel 27'	Ja	Zelf reinigen	Ja
Krystal	Ja	Hygiëne 99,9%	Ja
Snel - Volledig 60'	Ja	Delicate vaat	Ja
Eco	Ja		

Opties



Dry Assist + opties	Ja	FlexiZone ½ (halve beladingsmogelijkheid)	Ja
Delay timer optie	Tot 24 uur, i.c.m. automatisch spoelen	Optie speciale programma's	Ja

Korven

			
Kleur korven	Grijs	Maximum afmetingen bord dat in bovenste korf kan worden geladen	19,0 cm
Kleur korfcomponenten	Grijs	Onderkorf	2 inklapbare rekken
Handgreep	Op onder- en bovenkorf		
Bovenkorf	Met vaste rekken		
Glazen houder	Ja		

In hoogte verstelbare bovenkorf	3 niveaus	Onderkorf met anti-drup inserts	Ja
		Maximum afmetingen bord dat in onderste korf kan worden geladen	30,0 cm
		Kleur binnenonderdelen	Groen

Technische specificaties



Breedte product	598 mm	Maximale waterhardheid	100°FH;58°dH
Diepte product	545 mm	Droogsysteem	Natuurlijk condensor drogen met Dry Assist + automatische deuropeningsysteem aan het einde van de cyclus
Type display	LED display	Stoombeveiliging	Van kunststof
Hoogte product	818 mm	Materiaal kuip	Roestvrij staal
Bediening	Elektronisch	Filter	Roestvrij staal
Display	Instelling Delay timer, Programma duur indicator	Verborgен verwarmingselement	Ja
Grafische weergave programma's	Symbolen	Scharnieren	Zelfbalancerend met vast steunpunt
Zout indicator	Indicator (lampje)	Min. en max. frontaal paneelgewicht	2 - 9 kg
Glansspoelmiddel indicator	Indicator (lampje)	Min. en max plinthoogte	100 - 228 mm
Indicator einde cyclus	Akoestisch signaal	Verstelbare voetjes	7 cm, van 820 tot 890 mm
Wassysteem	Standaard	Back cover	Ja
Derde sproeiarm	Enkel	Diepte vaatwasser met open deur (mm)	1146
Waterontkalker	Elektronisch instelbaar	Voetjes achterzijde vanaf de voorkant regelbaar	Ja
Overstroombeveiliging	Total Acquastop	Bovenbedekking	Van kunststof
Watertoevoer	Enkel; koud en warm water tot 60°C - energiebesparing tot 35%		

Performance / Energy Label - Reg. 2019

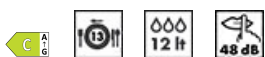

Energie-efficiëntieklasse (wascyclus)	C	Programmaduur	4:10 h:min
Energy consumption [per 100 cycles, based on the eco programme]	73 kWh	Geluidsniveau	48 dB(A) re 1 pW
Nominale capaciteit (ps)	13	Akoestisch geluidsemissieklasse	C
Water verbruik (per cyclus)	12,0 litres	Energy efficiency Index (EEI)	43,8

Elektrische aansluiting

Stekker	(F;E) Schuko	Frequentie	50 Hz
Aansluitwaarde	1800 W	Type aansluiting	Single-phase
Stroom	10 A	Lengte voedingskabel	140 cm
Spanning	220-240 V		

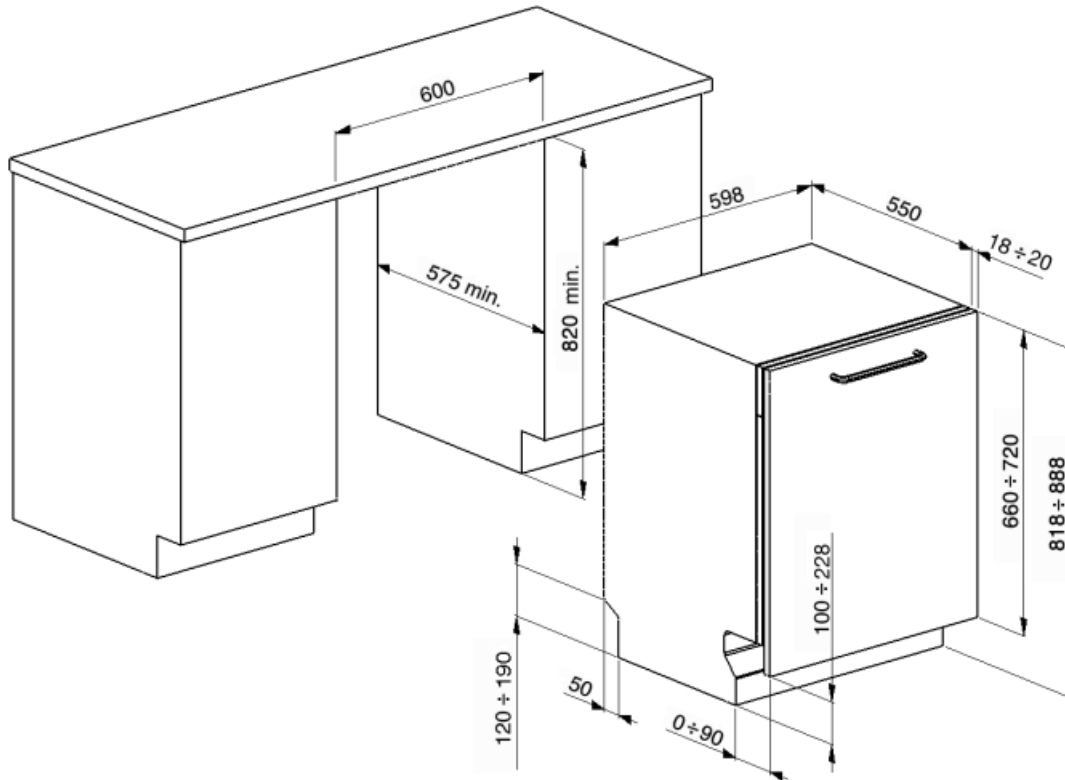

Accessoires niet inbegrepen

KITPL60FABB

Kit in witte kleur in hoogte verstelbaar. Kan over alle volledig geïntegreerde en onderbouwmodellen met vast steunpunt worden gemonteerd. Kan ook worden geïnstalleerd op de modellen met variabel draaipunt of flexifit-scharnieren.



KITPL60FABX

Kit in roestvrij staal in hoogte verstelbaar. Kan over alle volledig geïntegreerde en onderbouwmodellen met vast steunpunt worden gemonteerd. Kan ook worden geïnstalleerd op de modellen met variabel draaipunt of flexifit-scharnieren.



KIT82CX



KITPL60FABN

Kit in zwarte kleur in hoogte verstelbaar. Kan over alle volledig geïntegreerde en onderbouwmodellen met vast steunpunt worden gemonteerd. Kan ook worden geïnstalleerd op de modellen met variabel draaipunt of flexifit-scharnieren.



KITPLV2

Kit verlengstuk voor vaatwasser en wasmachine: lengte 2 mtr.



KITGH



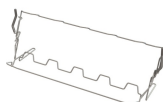



















Kit glazen houder. Deze moet op de eerste mand worden gemonteerd, maar alleen als er inklapbare rekken zijn



KIT82CN



Symbols glossary (TT)

 To improve the drying of dishes without leaving stains.	 Energy efficiency class C
 82 cm high	 Vertragingstimer: De uitgestelde timer kan de start van het programma tot 24 uur uitstellen.
 The Dry Assist + option, in addition to saving energy, ensures perfect drying of the dishes by opening the door automatically at the end of the washing cycle.	 FlexiZone: The ½ load flexizone allows you to wash a reduced load saving energy, water and time and there are no restrictions on where the items are placed.
 Noise Level: Excellent insulation and special devices keep noise to a minimum.	 Crystals: The Crystals programme is dedicated to delicate dishes such as glasses and china.
 Delicate: Delicate washing program is designed for delicate dishes which are not heavily soiled.	 Eco: Eco, this economic wash programme uses a low amount of water and energy in order to provide the most environmentally friendly cleaning option.
 Mix: The Mix programme is suitable for mixed crockery and everyday pots and pans, without any particular incrustation.	 Soak programme: The soak programme provides a rinse to prevent dirt from drying.
 Express 27': The Express 27' programme is a quick wash cycle, at low temperatures, for lightly soiled dishes.	 Quick wash cycle for normally soiled mixed loads such as dishes and pans, even with dried-on residues. Dishes are washed and dried in 60 minutes.
 Ultraclean: The Ultraclean option performs a final rinse at a high temperature of 70°C eliminating virtually all bacteria.	 13 place settings: Number of place settings.
 Total Acquastop: In addition to the partial Acquastop protection present in all Smeg dishwashers, some models have an electronic device fitted to the water intake hose, which monitors water levels in the machine, detects leaks in the hose and switches off the water supply immediately when necessary.	 System WaterSave ensures the best washing results with minimal water consumption depending on the model of dishwasher.
 Dishwasher cleaning cycle. The cycle should be started with the machine empty, without dishes. It is recommended to run the program every 2-3 months, using special dishwasher detergents.	 SILENT: Wash cycle suitable for normally soiled dishes, even with dried-on residues. Ensures maximum noise reduction and is therefore ideal if you wish to run it during the night.
 Allows you to enable additional programs when selected together with any wash cycle. After having selected the required wash cycle, press the button ( HYGIENE 99.9% High-temperature washing programme. The 75° rinse guarantees the removal of 99.9% of germs and bacteria.
 The work aimed at continuous improvement has allowed the creation of the second generation of the Inverter motor 2.0, characterised by greater efficiency and durability over time, which allows very high performance and a lower energy consumption and noise level.	