

ST4512IN



Product Family	Dishwashers
Commercial width	45 cm
Commercial height	82 cm
Installation	Fully-integrated built-in
Kitchen panel	Not supplied
N° baskets	2
Motor	Inverter
EAN code	8017709302894



Programme / Functions



N. of programmes	5	ECO	Yes
Washing temperatures	50, 60 °C	Intense 60°	Yes
Soak	Yes	Mix 60°	Yes
Express 50°	Yes		

Options



Delay timer option	3 hours
--------------------	---------

Baskets



Basket colour	Grey	Lower Basket	With fixed racks
Basket components colour	Grey	Lower basket with anti-drip inserts	Yes
Upper Basket	With central fixed racks	Largest loadable dish in lower basket	31,5 cm
Height adjustment of the upper basket	On two levels, by extraction	Colour Inner Components	Grey
Largest loadable dish in upper basket	20,0 cm	Cutlery basket	Yes

Technical Features



Width (mm)	446 mm	Max water hardness	90°fH; 50°dH
Depth (mm)	550 mm	Drying system	Natural condenser drying, with Dry Assist automatic door opening system at the end of the cycle
Product Height (mm)	818 mm	Steam protection	In plastic
Controls	Electronic	Tube material	Stainless steel
Programme graphics	Symbols	Filter	Stainless steel
On/off indicator	Yes	Concealed heating element	Yes
Salt light indicator	Light	Hinges	Self balancing, Sliding, FLEXIFIT
Rinse aid indicator	Light	Min. and max. frontal panel weight	2 - 7,5 kg
End of cycle indicator	Acoustic signal	Min. and max plinth height	40 - 175 mm
Washing system	Standard	Adjustable feet	6 cm, from 820 to 880 mm
Water softener	With electronic setting	Additional gaskets	Yes
Flood protection system	Single Acquastop	Depth of dishwasher with open door (mm)	1200
Water supply	Single; cold/hot water max. 60°C - energysave with hot water up to 35%	Back feet adjustable from front	Yes

Performance / Energy Label NEW 2019



Energy Efficiency Class	F	Programme duration	4:00 h:min
Energy consumption [per 100 cycles, based on the eco programme]	78 kWh	Airborne acoustical noise emissions	49 dB(A) re 1 pW
Rated capacity (ps)	9	Airborne acoustical noise emission class	C
Water consumption [per cycle]	9,9 litres	Energy efficiency Index (EEI)	61,8

Electrical Connection

Plug	(F;E) Schuko	Frequency (Hz)	50 Hz
Connected power	1950 W	Type of connection	Single-phase
Current	10 A	Power supply cable length	150 cm
Voltage	220-240 V		

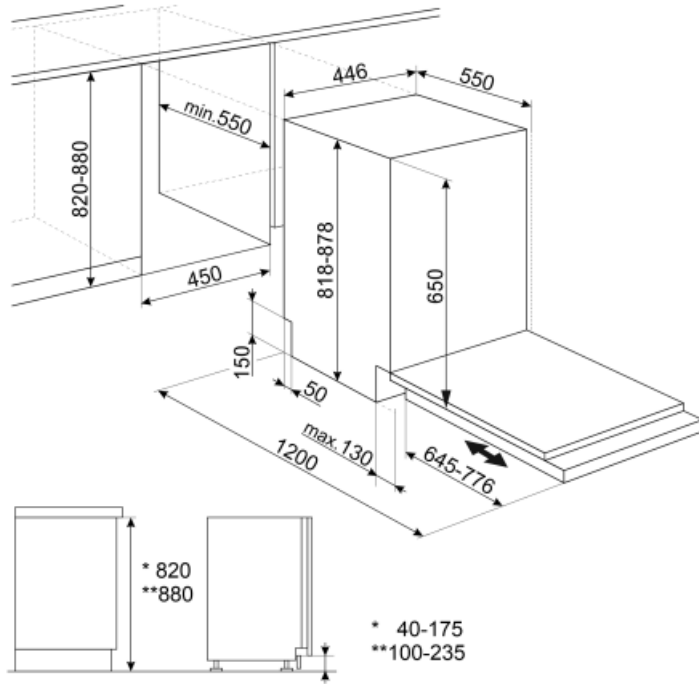















Not included accessories

KITPLV2

Kit extension for dishwasher and washing machine: lenght mt. 2



Symbols glossary (TT)

 <p>Acquastop: Some Smeg dishwashers are equipped with a simple Acquastop: float sensor in the bottom which is necessary to prevent an accidental leakage of water inside the appliance.</p>	 <p>To improve the drying of dishes without leaving stains.</p>
 <p>82 cm high</p>	 <p>Delay Timer: Option to postpone the start of the desired programme by up to 24 hours in order to programme the dishwasher to run at the desired time.</p>
 <p>The FlexiFit hinges allow the kitchen panel to slide over the dishwasher door, allowing a minimum kitchen plinth height of 5 cm.</p>	 <p>Smeg's evolution towards more intelligent and eco-friendly models has led to the choice of Inverter technology, which significantly reduces consumption.</p>
 <p>Noise Level: Excellent insulation and special devices keep noise to a minimum.</p>	 <p>Eco: Eco, this economic wash programme uses a low amount of water and energy in order to provide the most environmentally friendly cleaning option.</p>
 <p>Soak programme: The soak programme provides a rinse to prevent dirt from drying.</p>	 <p>A quick programme suitable for washing a load with fresh and light soil.</p>
 <p>Programme suitable for washing and drying heavily soiled items with encrusted residues.</p>	 <p>Programme suitable for washing and drying normally soiled items.</p>
 <p>Energy efficiency class F</p>	 <p>System WaterSave ensures the best washing results with minimal water consumption depending on the model of dishwasher.</p>
 <p>The symbols show the number of plate settings of the dishwasher.</p>	