

# ST4523IN



Familie	Vaatwasser
Commerciële breedte	45 cm
Nishoogte	82 cm
Installatie	Volledig geïntegreerd
Deur paneel	Niet meegeleverd
Aantal korven	3, Flexi
Motor	Inverter
EAN-code	8017709302917



## Programma's / functies

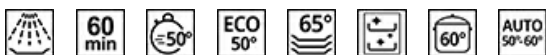

Aantal programma's	8	Eco	Ja
Wastemperatuur	50, 60 °C	Mix	Ja
Weken	Ja	Zelf reinigen	Ja
Snel - Volledig 60'	Ja	Intensief 60°	Ja
Snel 50°	Ja	Auto 50°-60°	Ja

## Opties



Delay timer optie	Tot 24 uur, i.c.m. automatisch spoelen	Crystal option	Ja
Extreme option	Ja		

## Korven

			
Kleur korven	Grijs	Maximum afmetingen bord dat in bovenste korf kan worden geladen	14,0 cm
Kleur korfcomponenten	Grijs	Onderkorf	Met vaste rekken
Handgreep	Op onder- en bovenkorf	Onderkorf met anti-drup inserts	Ja
Bovenkorf	Met vaste rekken		
In hoogte verstelbare bovenkorf	On two levels (4 cm)		

Maximum afmetingen bord dat in onderste korf kan worden geladen	31,5 cm
Kleur binnenonderdelen	Grijs

## Technische specificaties

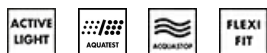

Breedte product	446 mm	Watertoevoer	Enkel; koud en warm water tot 60°C - energiebesparing tot 35%
Diepte product	550 mm	Maximale waterhardheid	90°FH; 50°dH
Type display	3 cijfers	Droogstelsysteem	Natural condenser drying, with Dry Assist automatic door opening system at the end of the cycle
Hoogte product	818 mm	Stoombeveiliging	Van kunststof
Bediening	Elektronisch	Materiaal kuip	Roestvrij staal
Display	Instelling Delay timer, Programma duur indicator	Filter	Roestvrij staal
Grafische weergave programma's	Symbolen	Verborgene verwarmingselement	Ja
Aan/uit indicator	Ja	Scharnieren	Self balancing, Sliding, FLEXIFIT
Zout indicator	Indicator (lampje)	Min. en max. frontaal paneelgewicht	2 - 7,5 kg
Glansspoelmiddel indicator	Indicator (lampje)	Min. en max. plinthoogte	40 - 175 mm
Indicator einde cyclus	ActiveLight	Verstelbare voetjes	6 cm, from 820 to 880 mm
Wassysteem	Standaard	Extra pakkingen	Ja
Waterontkalker	Elektronisch instelbaar	Diepte vaatwasser met open deur (mm)	1200
Aquatest sensor	Ja	Voetjes achterzijde vanaf de voorkant regelbaar	Ja
Overstroombeveiliging	Total Acquastop		

## Performance / Energy Label - Reg. 2019

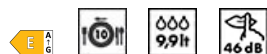

Energie-efficiëntieklasse E (wascyclus)	Programmaduur	4:00 h:min
Energy consumption [per 100 cycles, based on the eco programme]	Geluidsniveau	46 dB(A) re 1 pW
Nominale capaciteit (ps)	Akoestisch geluidsemissieklasse	C
Water verbruik (per cyclus)	Energy efficiency Index (EEI)	55.9

## Elektrische aansluiting

Stekker	(F;E) Schuko	Frequentie	50 Hz
---------	--------------	------------	-------

Aansluitwaarde	1950 W	Type aansluiting	Single-phase
Stroom	10 A	Lengte voedingskabel	150 cm
Spanning	220-240 V		

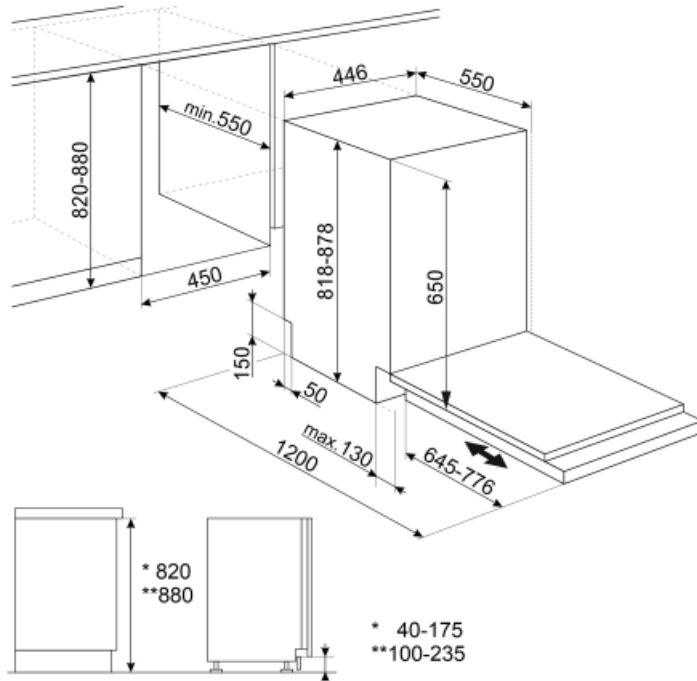

---

## Accessoires niet inbegrepen























---

### KITPLV2

Kit verlengstuk voor vaatwasser en wasmachine: lengte 2 mtr.



## Symbols glossary (TT)

	<p>Activelight is een led die een rode stip projecteert op de vloer onder de vaatwasser als het apparaat in gebruik is</p>		<p>Aquatest meet de helderheid van het water tijdens een automatisch programma en zorgt automatisch voor een minimaal verbruik van water en energie</p>
	<p>To improve the drying of dishes without leaving stains.</p>		<p>82 cm high</p>
	<p>Vertragingstimer: De uitgestelde timer kan de start van het programma tot 24 uur uitstellen.</p>		<p>The FlexiFit hinges allow the kitchen panel to slide over the dishwasher door, allowing a minimum kitchen plinth height of 5 cm.</p>
	<p>Invertertechnologie: De evolutie van Smeg's drogers naar intelligentere en milieuvriendelijkere modellen heeft geleid tot de keuze voor het gebruik van Invertertechnologie met warmtepompen, waardoor het energieverbruik aanzienlijk wordt verminderd.</p>		<p>Noise Level: Excellent insulation and special devices keep noise to a minimum.</p>
	<p>Eco: Eco, this economic wash programme uses a low amount of water and energy in order to provide the most environmentally friendly cleaning option.</p>		<p>Mix: The Mix programme is suitable for mixed crockery and everyday pots and pans, without any particular incrustation.</p>
	<p>Soak programme: The soak programme provides a rinse to prevent dirt from drying.</p>		<p>10 place settings: Number of place settings.</p>
	<p>Total Acquastop: In addition to the partial Acquastop protection present in all Smeg dishwashers, some models have an electronic device fitted to the water intake hose, which monitors water levels in the machine, detects leaks in the hose and switches off the water supply immediately when necessary.</p>		<p>A quick programme suitable for washing a load with fresh and light soil.</p>
	<p>Quick wash cycle for normally soiled mixed loads such as dishes and pans, even with dried-on residues. Dishes are washed and dried in 60 minutes.</p>		<p>Dishwasher cleaning cycle. The cycle should be started with the machine empty, without dishes. It is recommended to run the program every 2-3 months, using special dishwasher detergents.</p>
	<p>Wash cycle for normally soiled mixed loads such as dishes and pans, even with dried-on residues. When this program is selected, the dishwasher recognises the type of dirt and automatically adjusts the washing parameters as appropriate.</p>		<p>This option provides special care for a delicate load. It prevents rapid changes in the wash temperature of the selected programme and reduces it to 4</p>
	<p>Programme suitable for washing and drying heavily soiled items with encrusted residues.</p>		<p>Option which improves the washing results of the selected programme. It increases the wash temperature and duration.</p>
	<p>Energy efficiency class E</p>		<p>System WaterSave ensures the best washing results with minimal water consumption depending on the model of dishwasher.</p>