

STA4507



Product Family	Dishwashers
Width	45 cm
Commercial height	82 cm
Installation	Fully-integrated built-in
EAN code	8017709232320



Programmes



No. of programmes	5	ECO	Yes
Washing temperatures	45, 50, 65, 70 °C	Normal	Yes
Soak	Yes	Ultraclean	Yes
Glass	Yes		

Options



Delay timer option	3-6-9 hours, with automatic soak	Options for tabs FlexiTabs	Yes
--------------------	----------------------------------	----------------------------	-----

Baskets



Basket colour	Grey	Lower Basket	With fixed racks
Basket components colour	Grey	Lower basket with anti-drip inserts	Yes
Upper Basket	With central fixed racks	Largest loadable dish in lower basket	30,0 cm
Height adjustment of the upper basket	On three levels	Cutlery basket	10 place settings
Largest loadable dish in upper basket	18,5 cm		

Technical Features



Width (mm)	448 mm	Max water hardness	90°fH; 50°dH
Depth (mm)	545 mm	Drying system	Natural condenser drying
Product Height (mm)	818 mm	Steam protection	In plastic
Controls	Electronic	Tank material	Stainless steel
Programme graphics	Symbols	Filter	Stainless steel
On/off indicator	Yes	Concealed heating element	Yes
Salt light indicator	Light	Hinges	Self balancing with fixed hinges
Rinse aid indicator	Light	Min. and max. frontal panel weight	2 - 9 kg
End of cycle indicator	Acoustic signal	Adjustable feet	7cm, from 820 to 890 mm
Washing system	SwingWash	Back cover	Yes
Third spray arm	Single	Depth of dishwasher with open door (mm)	1146
Water softener	With electronic setting	Back feet adjustable from front	Yes
Flood protection system	Total Acquastop	Top cover	In plastic
Water supply	Single; cold/hot water max. 60°C - energysave with hot water up to 35%		

Electrical Connection

Plug	(F;E) Schuko	Frequency (Hz)	50 Hz
Connected power	1300 W	Type of connection	Single-phase
Current	10 A	Power supply cable length	140 cm
Voltage	220-240 V		

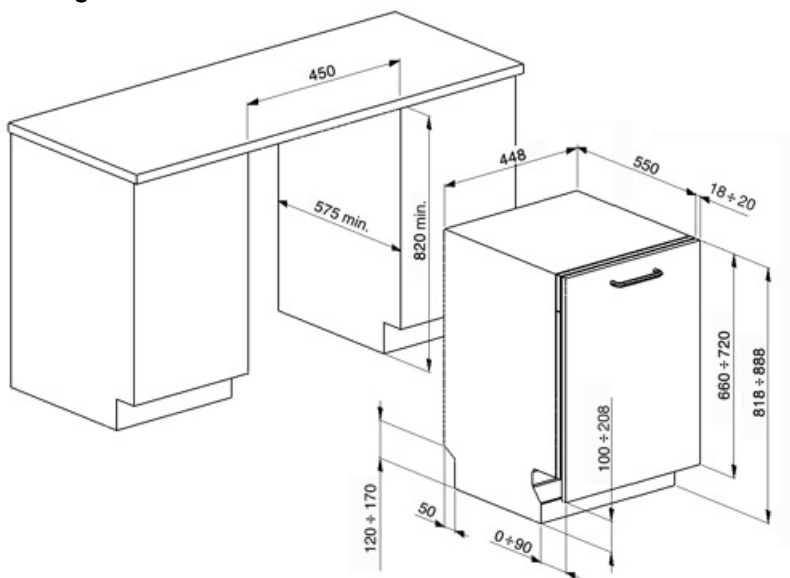













Not included accessories

KITPLV2

Kit extension for dishwasher and washing machine: length mt. 2



Symbols glossary

	A+: Energy efficiency class A+ helps to save up to 10% energy compared to class A. Maximum performance with minimum consumption is guaranteed.		Anti-drip: Some models of dishwashers are equipped with special polymer nozzles anti-drip, that improve the process of drying.
	COMM_HEIGHT_82_72dpi		Delay Timer: The delay timer can postpone the start of the program by up to 24 hours.
	Flexitabs: Flexitabs adjusts the wash cycle to give the best possible results regardless of the type of detergent used.		Noise Level: Excellent insulation and special devices keep noise to a minimum.
	Eco: Eco, this economic wash programme uses a low amount of water and energy in order to provide the most environmentally friendly cleaning option.		Soak programme: The soak programme provides a rinse to prevent dirt from drying.
	The symbols show the number of plate settings of the dishwasher.		Swing Wash System: The Swing Wash system ensures optimum water distribution throughout 45cm dishwasher tanks to deliver excellent wash results.
	Total Acquastop: In addition to the partial Acquastop protection present in all Smeg dishwashers, some models have an electronic device fitted to the water intake hose, which monitors water levels in the machine, detects leaks in the hose and switches off the water supply immediately when necessary.		System WaterSave ensures the best washing results with minimal water consumption depending on the model of dishwasher.