

# STA4507



Familie	Vaatwasser
Commerciële breedte	45 cm
Nishoogte	82 cm
Installatie	Volledig geïntegreerd
EAN-code	8017709232320



## Programs



Aantal programma's	5	Eco	Ja
Wastemperatuur	45, 50, 65, 70 °C	Normaal	Ja
Weken	Ja	Ultraclean	Ja
Glas	Ja		

## Opties



Delay timer optie	3-6-9 uur, i.c.m. automatisch spoelen	FlexiTabs optie	Ja
-------------------	---------------------------------------	-----------------	----

## Korven



Kleur korven	Grijs	Onderkorf	Met vaste rekken
Kleur korfcomponenten	Grijs	Onderkorf met anti-drup inserts	Ja
Bovenkorf	Met vaste rekken	Maximum afmetingen bord dat in onderste korf kan worden geladen	30,0 cm
In hoogte verstelbare bovenkorf	3 niveaus	Bestekmandje	10 couverts
Maximum afmetingen bord dat in bovenste korf kan worden geladen	18,5 cm		

## Technische specificaties



<b>Breedte product</b>	448 mm	<b>Maximale waterhardheid</b>	90°fH; 50°dH
<b>Diepte product</b>	545 mm	<b>Droogstelsysteem</b>	Natuurlijke condensatie
<b>Hoogte product</b>	818 mm	<b>Stoombeveiliging</b>	Van kunststof
<b>Bediening</b>	Elektronisch	<b>Materiaal kuip</b>	Roestvrij staal
<b>Grafische weergave programma's</b>	Symbolen	<b>Filter</b>	Roestvrij staal
<b>Aan/uit indicator</b>	Ja	<b>Verborgen verwarmingselement</b>	Ja
<b>Zout indicator</b>	Indicator (lampje)	<b>Scharnieren</b>	Zelfbalancerend met vast steunpunt
<b>Glansspoelmiddel indicator</b>	Indicator (lampje)	<b>Min. en max. frontaal paneelgewicht</b>	2 - 9 kg
<b>Indicator einde cyclus</b>	Akoestisch signaal	<b>Verstelbare voetjes</b>	7 cm, van 820 tot 890 mm
<b>Wassysteem</b>	SwingWash	<b>Back cover</b>	Ja
<b>Derde sproeiarm</b>	Enkel	<b>Diepte vaatwasser met open deur (mm)</b>	1146
<b>Waterontkalker</b>	Elektronisch instelbaar	<b>Voetjes achterzijde vanaf de voorkant regelbaar</b>	Ja
<b>Overstroombeveiliging</b>	Total Acquastop	<b>Bovenbedekking</b>	Van kunststof
<b>Watertoevoer</b>	Enkel; koud en warm water tot 60°C - energiebesparing tot 35%		

## Elektrische aansluiting

<b>Stekker</b>	(F;E) Schuko	<b>Frequentie</b>	50 Hz
<b>Aansluitwaarde</b>	1300 W	<b>Type aansluiting</b>	Single-phase
<b>Stroom</b>	10 A	<b>Lengte voedingskabel</b>	140 cm
<b>Spanning</b>	220-240 V		

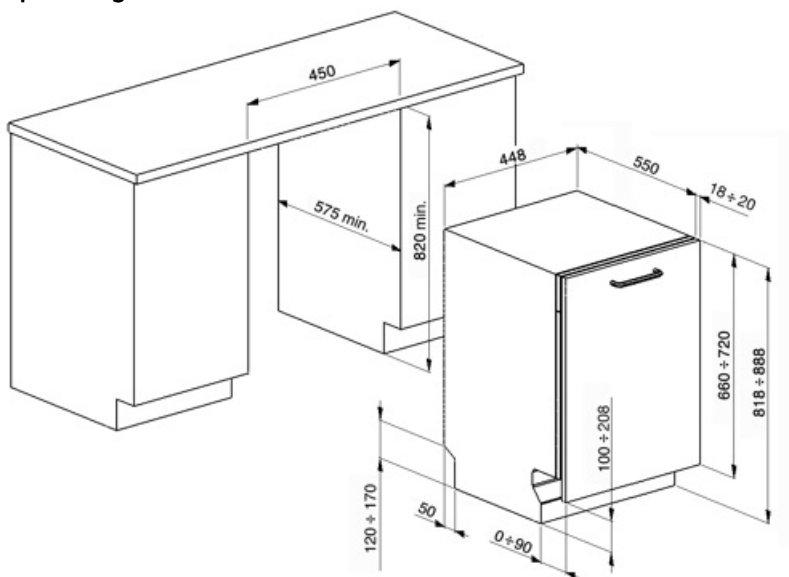

---

## Accessoires niet inbegrepen













---

### KITPLV2

Kit verlengstuk voor vaatwasser en wasmachine: lengte 2 mtr.



## Symbols glossary (TT)

	A +: Energie-efficiëntieklasse A + helpt om tot 10% energie te besparen in vergelijking met klasse A. Maximale prestaties bij minimaal verbruik zijn gegarandeerd.		To improve the drying of dishes without leaving stains.
	82 cm high		Vertragingstimer: De uitgestelde timer kan de start van het programma tot 24 uur uitstellen.
	Ideal for multi-function detergents, this option allows washing to be optimised, with full benefits from the combined-action tablets. When this option is activated, any salt and rinse aid is used.		Noise Level: Excellent insulation and special devices keep noise to a minimum.
	Eco: Eco, this economic wash programme uses a low amount of water and energy in order to provide the most environmentally friendly cleaning option.		Soak programme: The soak programme provides a rinse to prevent dirt from drying.
	10 place settings: Number of place settings.		Swing Wash System: The Swing Wash system ensures optimum water distribution throughout 45cm dishwasher tanks to deliver excellent wash results.
	Total Acquastop: In addition to the partial Acquastop protection present in all Smeg dishwashers, some models have an electronic device fitted to the water intake hose, which monitors water levels in the machine, detects leaks in the hose and switches off the water supply immediately when necessary.		System WaterSave ensures the best washing results with minimal water consumption depending on the model of dishwasher.