

STD413



Familie	Vaatwasser
Commerciële breedte	45 cm
Nishoogte	82 cm
Installatie	Volledig geïntegreerd
Deur paneel	Niet meegeleverd
Motor	Eenfasig
EAN-code	8017709183882



Programs

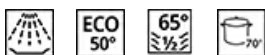

Aantal programma's	5	Eco	Ja
Wastemperatuur	45, 50, 65, 70 °C	Dagelijks ½ lading	Ja
Weken	Ja	Mix Express	Ja
Glas	Ja	Super	Ja

Opties



Delay timer optie	3-6-9 uur, i.c.m. automatisch spoelen	FlexiTabs optie	Ja
-------------------	---------------------------------------	-----------------	----

Korven



Kleur korven	Grijs	Onderkorf	Met vaste rekken
Kleur korfcomponenten	Grijs	Onderkorf met anti-drup inserts	Ja
Bovenkorf	Met vaste rekken	Maximum afmetingen bord dat in onderste korf kan worden geladen	30,0 cm
In hoogte verstelbare bovenkorf	3 niveaus	Bestekmandje	10 couverts
Maximum afmetingen bord dat in bovenste korf kan worden geladen	18,5 cm		

Technische specificaties



Breedte product	448 mm	Droogstelsysteem	Natuurlijke condensatie
Diepte product	545 mm	Stoombeveiliging	Van kunststof
Hoogte product	818 mm	Materiaal kuip	Roestvrij staal
Bediening	Elektronisch	Filter	Roestvrij staal
Grafische weergave programma's	Symbolen	Verborgen verwarmingselement	Ja
Aan/uit indicator	Ja	Scharnieren	Zelfbalancerend met vast steunpunt
Zout indicator	Indicator (lampje)	Min. en max. frontaal paneelgewicht	2 - 9 kg
Glansspoelmiddel indicator	Indicator (lampje)	Min. en max. plinthoogte	100 - 208 mm
Indicator einde cyclus	Akoestisch signaal	Verstelbare voetjes	7 cm, van 820 tot 890 mm
Wassysteem	SwingWash	Geluidsisolatie niveau	lper
Derde sproeiarm	Enkel	Back cover	Ja
Waterontkalker	Elektronisch instelbaar	Diepte vaatwasser met open deur (mm)	1146
Overstroombeveiliging	Total Acquastop	Voetjes achterzijde vanaf de voorkant regelbaar	Ja
Watertoevoer	Enkel; koud en warm water tot 60°C - energiebesparing tot 35%	Bovenbedekking	Van kunststof
Maximale waterhardheid	90°FH; 50°dH		

Elektrische aansluiting

Stekker	(F;E) Schuko	Frequentie	50 Hz
Aansluitwaarde	1300 W	Type aansluiting	Single-phase
Stroom	10 A	Lengte voedingskabel	140 cm
Spanning	220-240 V		

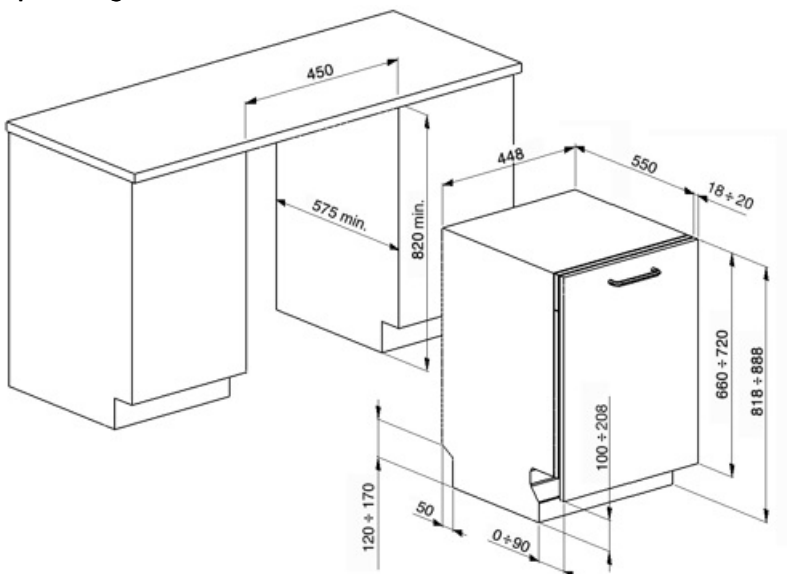















Accessoires niet inbegrepen

KITPLV2

Kit verlengstuk voor vaatwasser en wasmachine: lengte 2 mtr.



Symbols glossary (TT)

 <p>A +: Energie-efficiëntieklasse A + helpt om tot 10% energie te besparen in vergelijking met klasse A. Maximale prestaties bij minimaal verbruik zijn gegarandeerd.</p>	 <p>To improve the drying of dishes without leaving stains.</p>
 <p>82 cm high</p>	 <p>Vertragingstimer: De uitgestelde timer kan de start van het programma tot 24 uur uitstellen.</p>
 <p>Ideal for multi-function detergents, this option allows washing to be optimised, with full benefits from the combined-action tablets. When this option is activated, any salt and rinse aid is used.</p>	 <p>Noise Level: Excellent insulation and special devices keep noise to a minimum.</p>
 <p>1/2 load: This program is designed for washing dishes not heavily soiled with partial load of the dishwasher.</p>	 <p>Eco: Eco, this economic wash programme uses a low amount of water and energy in order to provide the most environmentally friendly cleaning option.</p>
 <p>Soak programme: The soak programme provides a rinse to prevent dirt from drying.</p>	 <p>PRG_STRONG_72dpi</p>
 <p>10 place settings: Number of place settings.</p>	 <p>Swing Wash System: The Swing Wash system ensures optimum water distribution throughout 45cm dishwasher tanks to deliver excellent wash results.</p>
 <p>Total Acquastop: In addition to the partial Acquastop protection present in all Smeg dishwashers, some models have an electronic device fitted to the water intake hose, which monitors water levels in the machine, detects leaks in the hose and switches off the water supply immediately when necessary.</p>	 <p>System WaterSave ensures the best washing results with minimal water consumption depending on the model of dishwasher.</p>