

# STE8639L



<b>Product Family</b>	Dishwashers
<b>Width</b>	60 cm
<b>Commercial height</b>	Maxi, 86cm
<b>Installation</b>	Fully-integrated built-in
<b>Kitchen panel</b>	Not supplied
<b>N° baskets</b>	3, FlexiDuo
<b>Motor</b>	Inverter
<b>EAN code</b>	8017709224042



## Programmes



<b>No. of programmes</b>	5+5 quick programmes	<b>Auto sensor 45-65</b>	Yes
<b>Washing temperatures</b>	38, 45, 50, 55, 65, 70 °C	<b>Ultraclean</b>	Yes
<b>Soak</b>	Yes	<b>ECO Quick</b>	Yes
<b>Rapid 27'</b>	Yes	<b>Delicate and Quick</b>	Yes
<b>Glass</b>	Yes	<b>Mix Express</b>	Yes
<b>ECO</b>	Yes	<b>Strong and fast</b>	Yes

## Options

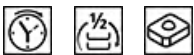

<b>Energy saving option EnerSave</b>	Yes	<b>Options for tabs FlexiTabs</b>	Yes
<b>Delay timer option</b>	Up to 24 hours, with automatic soak	<b>Quick Time option</b>	Yes
<b>1/2 load FlexiZone option (varied distribution)</b>	Yes		

## Baskets



<b>Basket colour</b>	Stainless Steel	<b>Largest loadable dish in upper basket</b>	18,0 cm
<b>Basket components colour</b>	Blue	<b>Lower Basket</b>	With completely foldable racks and glass holder

<b>Handle</b>	In plastic with stainless steel insert on upper and lower basket	<b>Lower basket with anti-drip inserts</b>	Yes
<b>Upper Basket</b>	With central fixed racks and glass holder	<b>Largest loadable dish in lower basket</b>	35,0 cm
<b>Height adjustment of the upper basket</b>	On three levels	<b>Colour Inner Components</b>	Blue anti drop inserts, Blue handles, Grey pastic plate for regulation second basket on three levels, Grey Flexiduo, Blue Planetarium, Blue plastic plate support for glass holder
<b>Sliding Guides Extra Glide</b>	Yes	<b>Cutlery basket</b>	13 place settings sliding

## Technical Features



<b>Width (mm)</b>	598 mm	<b>Max water hardness</b>	100°FH;58°dH
<b>Depth (mm)</b>	550 mm	<b>Drying system</b>	Natural condenser drying, with EnerSave automatic door opening system at the end of the cycle
<b>Display type</b>	3 digit	<b>Steam protection</b>	In plastic
<b>Product Height (mm)</b>	858 mm	<b>Internal light</b>	With White led
<b>Watersave system</b>	Yes	<b>Tank material</b>	Stainless steel
<b>Controls</b>	Electronic	<b>Filter</b>	Stainless steel
<b>Display</b>	Delayed start, Programme time indicator, Time to end indication	<b>Concealed heating element</b>	Yes
<b>Programme graphics</b>	Symbols	<b>Hinges</b>	Self balancing, Sliding, FLEXIFIT
<b>On/off indicator</b>	Yes	<b>Min. and max. frontal panel weight</b>	2 - 10 kg
<b>Salt light indicator</b>	Light	<b>Min. and max plinth height</b>	50 - 215 mm
<b>Rinse aid indicator</b>	Light	<b>Can be installed in-column</b>	Yes
<b>End of cycle indicator</b>	ActiveLight	<b>Adjustable feet</b>	7cm, from 860 to 930 mm
<b>Washing system</b>	Planetarium	<b>Insulation level</b>	Top
<b>Third spray arm</b>	Single	<b>Additional gaskets</b>	Yes, with stainless steel plate
<b>Water softener</b>	With electronic setting	<b>Back cover</b>	Yes
<b>Turbidity sensor</b>	Yes	<b>Depth of dishwasher with open door (mm)</b>	1146 mm
<b>Aquatest</b>		<b>Back feet adjustable from front</b>	Yes
<b>Flood protection system</b>	Total Acquastop	<b>Top cover</b>	In plastic
<b>Water supply</b>	Single; cold/hot water max. 60°C - energysave with hot water up to 35%		

## Performance / Energy Label

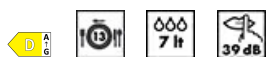

<b>Energy Efficiency Class (Washing cycle)</b>	D	<b>Airborne acoustical noise emissions (spinning phase)</b>	39 dB(A) re 1 pW
--	---	---	------------------

**Energy consumption** 81 kWh  
 [per 100 cycles, based  
 on the eco programme]  
**Rated capacity (ps)** 13  
**Water consumption [per  
 cycle]** 7,0 litres

**Airborne acoustical  
 noise emission class** B  
**Energy efficiency Index  
 (EEI) (Washing cycle)** 48,4

## Electrical Connection

**Connected power** 1800 W  
**Current** 10 A  
**Voltage** 220-240 V  
**Frequency (Hz)** 50 Hz

**Type of connection** Single-phase  
**Power supply cable  
 length** 140 cm  
**Plug** (F;E) Schuko

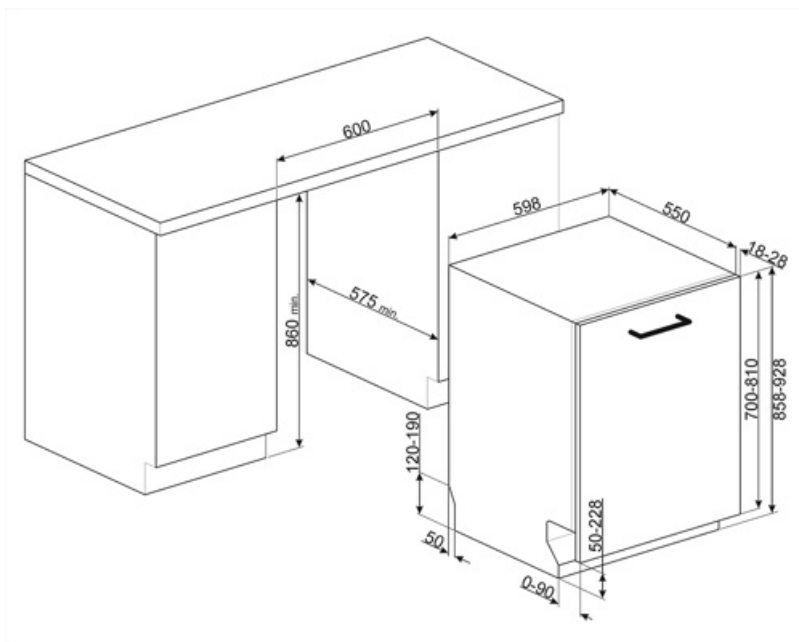

## Compatible Accessories



### KITFLEXI

Kit for 60cm dishwashers with FlexiFit hinges for door panel weight >11 kg (max 15 kg 82 cm and 13,5 kg 86 cm)



### KITPL60B

Toekick Kit in White colour with adjustable height and deepness. Can be installed over all the fully integrated and underbench models with variable fulcrum or flexifit hinges.



### KITPL60X

Toekick Kit in Stainless Steel with adjustable height and deepness. Can be fitted over all the fully integrated and underbench models with variable fulcrum or flexifit hinges.

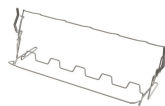

### KITGH

Kit glass holder. It has to be fitted on the first basket but only if there are foldable racks



### KITPL60N























Toekick Kit in Black colour with adjustable height and deepness. Can be installed over all the fully integrated and underbench models with variable fulcrum or flexifit hinges.



### KITPLV2

Kit extension for dishwasher and washing machine: length mt. 2

## Symbols glossary

 <p><b>A+++:</b> Appliances with this symbol can reduce energy consumption by a further 30% from the standard A energy rating.</p>	 <p><b>Activelight</b> is an led light which projects a red spot onto the floor beneath the dishwasher when the appliance is in use.</p>
 <p><b>Aquatest</b> measures the clarity of the water during an auto program, and automatically ensures the minimum consumption of water and energy.</p>	 <p><b>Anti-drip:</b> Some models of dishwashers are equipped with special polymer nozzles anti-drip, that improve the process of drying.</p>
 <p><b>Installation in column:</b> Installation in column</p>	 <p><b>COMM_HEIGHT_86_72dpi</b></p>
 <p><b>Delay Timer:</b> The delay timer can postpone the start of the program by up to 24 hours.</p>	 <p><b>Fingerprint proof stainless steel:</b> Fingerprint proof stainless steel keeps stainless steel looking as good as new.</p>
 <p><b>FlexiDuo:</b> The FlexiDuo 3rd cutlery basket allows you to arrange cutlery or small cups, ladles, or bulky utensils however you like: it consists of two separate and moveable modules.</p>	 <p>Models with new Flexi Fit hinges are able to be installed in kitchens with a plinth of just 5cms. With this new hinge design, the panel has a sliding movement from the bottom to the top, avoiding any possible interference of the panel with the plinth.</p>
 <p><b>Flexitabs:</b> Flexitabs adjusts the wash cycle to give the best possible results regardless of the type of detergent used.</p>	 <p><b>FlexiZone:</b> The ½ load flexizone allows you to wash a reduced load saving energy, water and time and there are no restrictions on where the items are placed.</p>
 <p>The new ExtraGlide guide system, available on top of the range models, makes the second basket even smoother and softer. In fact, it facilitates the extraction of the introduction, even at full load and, for the greater excursion, the insertion of crockery is also facilitated in the rear part.</p>	 <p><b>Inverter technology:</b> The evolution of Smeg's driers towards more intelligent and environmentally sustainable models has led to the choice of using Inverter technology with heat pumps, which reduces significantly energy consumption.</p>
 <p><b>Noise Level:</b> Excellent insulation and special devices keep noise to a minimum.</p>	 <p><b>PLANETARIUM_WASHING_SYSTEM_72dpi</b></p>
 <p><b>Auto 45°- 65°:</b> The auto programme regulates the length of a cycle depending on the need for a pre-wash and the number of rinses required.</p>	 <p><b>Delicate Quick:</b> Program Delicate Quick is suitable for quick washing of delicate dishes.</p>
 <p><b>Eco:</b> Eco, this economic wash programme uses a low amount of water and energy in order to provide the most environmentally friendly cleaning option.</p>	 <p><b>Eco:</b> Eco, this economic wash programme uses a low amount of water and energy in order to provide the most environmentally friendly cleaning option.</p>
 <p><b>Soak programme:</b> The soak programme provides a rinse to prevent dirt from drying.</p>	 <p><b>Strong&amp;Fast:</b> This special programme takes less than 1 hour to eliminate the most stubborn dirt and dried on residues.</p>



The symbols show the number of plate settings of the dishwasher.



Total Acquastop: In addition to the partial Acquastop protection present in all Smeg dishwashers, some models have an electronic device fitted to the water intake hose, which monitors water levels in the machine, detects leaks in the hose and switches off the water supply immediately when necessary.



System WaterSave ensures the best washing results with minimal water consumption depending on the model of dishwasher.



System WaterSave ensures the best washing results with minimal water consumption depending on the model of dishwasher.



Energy efficiency class D