

# STL233CLH



<b>Product Family</b>	Dishwashers
<b>Commercial width</b>	60 cm
<b>Commercial height</b>	86 cm
<b>Installation</b>	Fully-integrated built-in
<b>Kitchen panel</b>	Not supplied
<b>N° baskets</b>	2
<b>Motor</b>	Inverter 2.0
<b>EAN code</b>	8017709307424



## Programs



<b>N. of programmes</b>	10+1	<b>Auto sensor 45-65</b>	Yes
<b>Washing temperatures</b>	38, 45, 50, 55, 65, 70, 75 °C	<b>Mix</b>	Yes
<b>Soak</b>	Yes	<b>Quiet (-2 dB)</b>	Yes
<b>Express 27'</b>	Yes	<b>Intense</b>	Yes
<b>Crystal</b>	Yes	<b>Self clean</b>	Yes
<b>Full express - 60 minutes</b>	Yes	<b>Hygiene 99,9%</b>	Yes
<b>ECO</b>	Yes		

## Options



<b>Dry Assist+ option</b>	Yes	<b>Intensive wash zone option</b>	
<b>Delay timer option</b>	Up to 24 hours	<b>Special programs option</b>	Yes
<b>1/2 load FlexiZone option</b>	Yes		

## Baskets



<b>Basket colour</b>	Grey	<b>Largest loadable dish in upper basket</b>	25,0 cm
<b>Basket components colour</b>	Grey	<b>Lower Basket</b>	With 2 foldable racks

<b>Handle</b>	In plastic on upper and lower basket	<b>Lower basket with anti-drip inserts</b>	Yes
<b>Upper Basket</b>	With 1 foldable rack	<b>Largest loadable dish in lower basket</b>	35,0 cm
<b>Glass holder</b>	Yes	<b>Colour Inner Components</b>	Blue
<b>Height adjustment of the upper basket</b>	On three levels (5 cm)	<b>Cutlery basket</b>	Yes
<b>Upper basket with EasyGlide System</b>	Yes		

## Technical Features



<b>Width (mm)</b>	598 mm	<b>Water supply</b>	Single; cold/hot water max. 60°C - energysave with hot water up to 35%
<b>Depth (mm)</b>	550 mm	<b>Max water hardness</b>	100°FH;58°dH
<b>Display type</b>	LED display (3 digit)	<b>Drying system</b>	Natural condenser drying, with Dry Assist + automatic door opening system at the end of the cycle
<b>Product Height (mm)</b>	858 mm	<b>Steam protection</b>	In plastic
<b>Controls</b>	Electronic	<b>Tube material</b>	Stainless steel
<b>Display</b>	Delayed start, Programme time indicator	<b>Filter</b>	Stainless steel
<b>Programme graphics</b>	Symbols	<b>Concealed heating element</b>	Yes
<b>Salt light indicator</b>	Light	<b>Hinges</b>	Self balancing, Sliding, FLEXIFIT
<b>Rinse aid indicator</b>	Light	<b>Min. and max. frontal panel weight</b>	2,5 - 10 kg
<b>End of cycle indicator</b>	ActiveLight	<b>Min. and max plinth height</b>	50 - 215 mm
<b>Auto switch-off</b>	Yes	<b>Adjustable feet</b>	7 cm, from 860 to 930 mm
<b>Washing system</b>	Planetarium	<b>Additional gaskets</b>	Yes, with stainless steel plate
<b>Third spray arm</b>	Single	<b>Back cover</b>	Yes
<b>Water softener</b>	With electronic setting	<b>Depth of dishwasher with open door (mm)</b>	1186 mm
<b>Turbidity sensor</b>	Yes	<b>Back feet adjustable from front</b>	Yes
<b>Aquatest</b>		<b>Top cover</b>	In plastic
<b>Flood protection system</b>	Total Acquastop		

## Performance / Energy Label - Reg. 2019

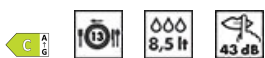

<b>Energy Efficiency Class</b>	C	<b>Programme duration</b>	4:40 h:min
<b>Energy consumption [per 100 cycles, based on the eco programme]</b>	73 kWh	<b>Airborne acoustical noise emissions</b>	43 dB(A) re 1 pW
<b>Rated capacity (ps)</b>	13	<b>Airborne acoustical noise emission class</b>	B
<b>Water consumption [per cycle]</b>	8,5 litres		

Energy efficiency Index (EEI) 43,8

## Electrical Connection

Connected power	1800 W	Type of connection	Single-phase
Current	10 A	Power supply cable length	140 cm
Voltage	220-240 V	Plug	(F;E) Schuko
Frequency (Hz)	50 Hz		

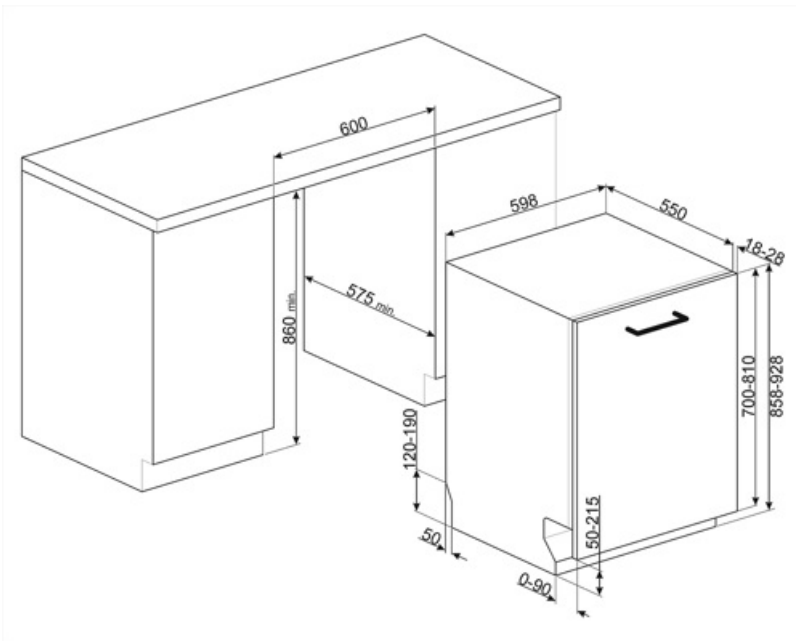

## Compatible Accessories



### KIT86CX-1

Door kit, stainless steel, Canali handle, fully integrated dishwasher h.86 cm  
Compatible with models with Flexifit and fixed fulcrum hinges.



### KIT86PORTRD



### KIT86PORTX-1



### KIT86SPRMW



### KIT86PORTAN-1



### KIT86PORTWH-1



### KIT86SPRAN



### KIT86SPRX



### KITFLEXI

Kit for 60cm dishwashers with FlexiFit hinges for door panel weight >11 kg (max 15 kg 82 cm and 13,5 kg 86 cm)

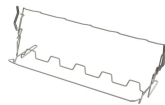

### KITGH

Kit glass holder. It has to be fitted on the first basket but only if there are foldable racks



### KITPL60B

Toekick Kit in White colour with adjustable height and deepness. Can be installed over all the fully integrated and underbench models with variable fulcrum or flexifit hinges.



### KITPL60N

Toekick Kit in Black colour with adjustable height and deepness. Can be installed over all the fully integrated and underbench models with variable fulcrum or flexifit hinges.



### KITPL60X























Toekick Kit in Stainless Steel with adjustable height and deepness. Can be fitted over all the fully integrated and underbench models with variable fulcrum or flexifit hinges.



### KITPLV2

Kit extension for dishwasher and washing machine: lenght mt. 2

## Symbols glossary

 <p>Activelight is an led light which projects a red spot onto the floor beneath the dishwasher when the appliance is in use.</p>	 <p>The Aquatest sensor is an electronic sensor that measures the degree of water transparency at the end of the initial soaking phase. Based on the values measured, the sensor sets the most suitable programme, thus obtaining the best washing results with the minimum amount of water.</p>
 <p>To improve the drying of dishes without leaving stains.</p>	 <p>86 cm high</p>
 <p>Delay Timer: Option to postpone the start of the desired programme by up to 24 hours in order to programme the dishwasher to run at the desired time.</p>	 <p>EasyGlide: Convenient EasyGlide system for easy unloading of the appliance that allows reaching maximum flexibility of load of the machine.</p>
 <p>The FlexiFit hinges allow the kitchen panel to slide over the dishwasher door, allowing a minimum kitchen plinth height of 5 cm.</p>	 <p>FlexiZone: The ½ load flexizone allows you to wash a reduced load saving energy, water and time and there are no restrictions on where the items are placed.</p>
 <p>Noise Level: Excellent insulation and special devices keep noise to a minimum.</p>	 <p>The Planetarium washing system, with high rotations per minute, guarantees complete coverage of the tank, thanks to the simultaneous rotation of base and sprayers, and excellent washing results.</p>
 <p>Auto 45°- 65°: The auto programme regulates the length of a cycle depending on the need for a pre-wash and the number of rinses required.</p>	 <p>Crystals: The Crystals programme is dedicated to delicate dishes such as glasses and china.</p>
 <p>Eco: Eco, this economic wash programme uses a low amount of water and energy in order to provide the most environmentally friendly cleaning option.</p>	 <p>Mix: The Mix programme is suitable for mixed crockery and everyday pots and pans, without any particular incrustation.</p>
 <p>Soak programme: The soak programme provides a rinse to prevent dirt from drying.</p>	 <p>Express 27': The Express 27' programme is a quick wash cycle, at low temperatures, for lightly soiled dishes.</p>
 <p>Ultraclean: The Ultraclean option performs a final rinse at a high temperature of 70°C eliminating virtually all bacteria.</p>	 <p>13 place settings: Number of place settings.</p>
 <p>Total Acquastop: In addition to the partial Acquastop protection present in all Smeg dishwashers, some models have an electronic device fitted to the water intake hose, which monitors water levels in the machine, detects leaks in the hose and switches off the water supply immediately when necessary.</p>	 <p>System WaterSave ensures the best washing results with minimal water consumption depending on the model of dishwasher.</p>
 <p>Quick wash cycle for normally soiled mixed loads such as dishes and pans, even with dried-on residues. Dishes are washed and dried in 60 minutes.</p>	 <p>Dishwasher cleaning cycle. The cycle should be started with the machine empty, without dishes. It is recommended to run the program every 2-3 months, using special dishwasher detergents.</p>



**SILENT:** Wash cycle suitable for normally soiled dishes, even with dried-on residues. Ensures maximum noise reduction and is therefore ideal if you wish to run it during the night.



The Dry Assist + option, in addition to saving energy, ensures perfect drying of the dishes by opening the door automatically at the end of the washing cycle.



**HYGIENE 99.9%** High-temperature washing programme. The 75° rinse guarantees the removal of 99.9% of germs and bacteria.



Allows you to enable additional programs when selected together with any wash cycle.



Energy efficiency class C



The work aimed at continuous improvement has allowed the creation of the second generation of the Inverter motor 2.0, characterised by greater efficiency and durability over time, which allows very high performance and a lower energy consumption and noise level.

