

STL281DS



Product Family	Dishwashers
Commercial width	60 cm
Commercial height	82 cm
Installation	Totalmente-integrado embutido
N° cestos	2
EAN code	8017709306915



Programas



N. of programmes	5	Mistura	Sim
Washing temperatures	50, 65, 70 °C	Intenso	Sim
Soak	Yes	1/2 load	Yes
ECO	Yes		

Options



Delay timer option	3-6-9 hours	Intensive wash zone option	
Extra dry option	Yes		

Baskets



Basket colour	Grey	Sliding Guides Extra Glide	No
Basket components colour	Grey	Largest loadable dish in upper basket	25,0 cm
Handle	No	Lower Basket	With fixed racks
Upper Basket	With central fixed racks	Lower basket with anti-drip inserts	Yes
Suporte de copo	Sim	Largest loadable dish in lower basket	30,0 cm
Height adjustment of the upper basket	On three levels	Colour Inner Components	Blue
Upper basket with EasyGlide System	No		

Cutlery basket

Sim

Technical Features



Largura do produto (mm)	598 mm
Profundidade do produto (mm)	545 mm
Altura do produto (mm)	818 mm
Watersave system	No
Controls	Electronic
Display	No
Gráfico dos programas	Símbolos
On/off indicator	Yes
Salt light indicator	Light
Rinse aid indicator	Light
Progress indicator	No
End of cycle indicator	Acoustic signal
Washing system	Standard
Third spray arm	Single
Water softener	With electronic setting
Turbidity sensor Aquatest	No
Flood protection system	Single Acquastop
Water supply	Single; cold/hot water max. 60°C - energysave with hot water up to 35%
Max water hardness	100°FH;58°dH

Drying system

Secagem por condensador natural, com sistema automático de abertura de portas Dry Assist no final do ciclo

Steam protection

In plastic

Child safety system (door lock)

No

Internal light

No

Push-pull opening system without handle

No

Tube material

Stainless steel

Filter

Stainless steel

Concealed heating element

Yes

Hinges

Self balancing, Sliding, FLEXIFIT

Peso mínimo e máximo do painel frontal

2 - 11 kg

Altura mínima e máxima do plinto

50 - 215 mm

Can be installed in-column

No

Adjustable feet

7cm, from 820 to 890 mm

Adjustable door

No

Tampo traseiro

Sim

profundidade da máquina de lavar louça com porta aberta (mm)

1168

Back feet adjustable from front

Yes

Tampo superior

Tampo superior em plástico

Etiqueta de Desempenho / Energia - Reg. 2019



Classe de eficiência energética	D
Consumo de energia [por 100 ciclos, com base no programa eco]	84 kWh
Capacidade nominal (ps)	13
Consumo de água [por ciclo]	12.0 litres

Duração do programa	3:35 h:min
Emissões de ruído acústico aerotransportado	48 dB(A) re 1 pW
Classe de emissão de ruído acústico aerotransportado	C
Índice de eficiência energética (IEE)	49.9

Electrical Connection

Plug	(F;E) Schuko	Frequency (Hz)	50 Hz
Connected power	1800 W	Type of connection	Single-phase
Current	10 A	Power supply cable length	140 cm
Voltage	220-240 V		

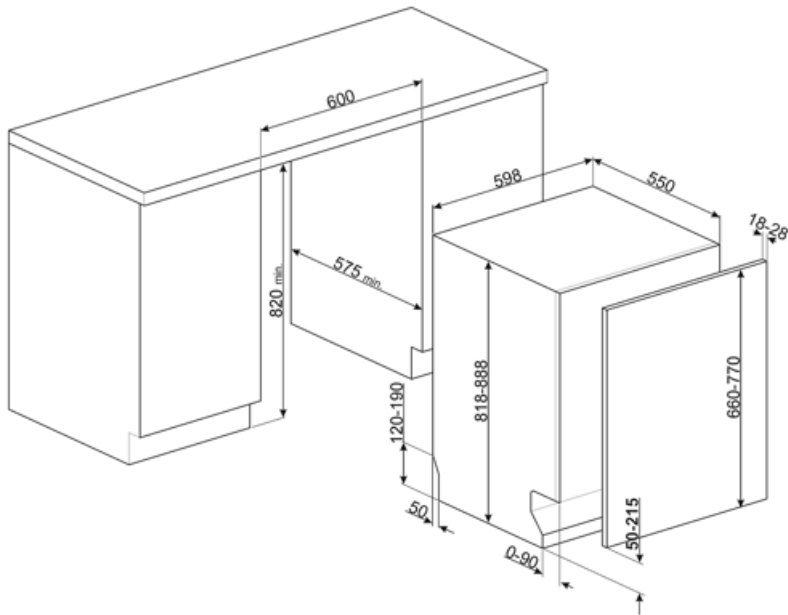

Compatible Accessories



KIT82CN



KIT82CX



KITFLEXI

Kit for 60cm dishwashers with FlexiFit hinges for door panel weight >11 kg (max 15 kg 82 cm and 13,5 kg 86 cm)



KITPL60B

Kit Toekick na cor branca com altura e profundidade ajustáveis. Pode ser instalado em todos os modelos totalmente integrados e sob bancada com dobradiças flexíveis ou de fulcro variável.



KITPL60N

Toekick Kit na cor preta com altura e profundidade ajustáveis. Pode ser instalado em todos os modelos totalmente integrados e sob bancada com dobradiças flexíveis ou de fulcro variável.



KITPL60X

















Kit Toekick em Aço Inoxidável com altura e profundidade ajustáveis. Pode ser montado em todos os modelos totalmente integrados e sob bancada com fulcro variável ou dobradiças flexíveis.



KITPLV2

Extensão do kit para máquina lava-louça e máquina de lavar: comprimento mt. 2

Symbols glossary

	<p>Aquastop: Algumas máquinas lava-louças Smeg estão equipadas com um sensor Aquastop: boia simples na parte inferior, que é necessária para evitar um vazamento acidental de água dentro do aparelho.</p>		<p>Anti-gotejamento: Alguns modelos de máquinas lava-louças são equipados com bicos de polímero especiais anti-gotejamento, que melhoram o processo de secagem.</p>
	<p>Classe de eficiência energética D</p>		<p>COMM_HEIGHT_82_72dpi</p>
	<p>Temporizador de atraso: O temporizador de atraso pode adiar o início do programa por até 24 horas.</p>		<p>Modelos com novas dobradiças Flexi Fit podem ser instalados em cozinhas com um plinto de apenas 5cms. Com este novo design de dobradiça, o painel tem um movimento deslizante da parte inferior para a parte superior, evitando qualquer possível interferência do painel com o plinto.</p>
	<p>Nível de ruído: O excelente isolamento e os dispositivos especiais mantêm o ruído ao mínimo.</p>		<p>1/2 carga: Este programa é projetado para lavar pratos não muito sujos com carga parcial da máquina lava-louça.</p>
	<p>Eco: Eco, este programa de lavagem económica utiliza uma baixa quantidade de água e energia para proporcionar a opção de limpeza mais ecológica.</p>		<p>Programa normal: O programa normal é adequado para graus normais de sujidade para uso diário.</p>
	<p>Programa de imersão: O programa de imersão fornece um enxágue para evitar que a sujeira seque.</p>		<p>Ultralimpo: A opção Ultralimpo realiza um enxágue final a uma temperatura elevada de 70° C eliminando praticamente todas as bactérias.</p>
	<p>Os símbolos mostram o número de configurações da placa da máquina lava-louça.</p>		<p>O sistema Economia de água garante os melhores resultados de lavagem com um consumo mínimo de água, dependendo do modelo da máquina lava-louça.</p>
	<p>...</p>		

Benefit (TT)

Flexifit hinge system

Smooth-running door for optimal integration into the kitchen design

The height of the plinth can vary from 5 cm to 21.5 cm, allowing it to fit perfectly into the cabinet.

Thanks to this solution, the dishwasher blends harmoniously into its surroundings, with the door and plinth perfectly aligned with the other kitchen furniture.