

# STL323DALH

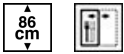

<b>Product Family</b>	Dishwashers
<b>Commercial width</b>	60 cm
<b>Commercial height</b>	86 cm
<b>Installation</b>	Fully-integrated built-in
<b>Kitchen panel</b>	Not supplied
<b>N° baskets</b>	3, FlexiDuo
<b>EAN code</b>	8017709309589



## Programs



<b>N. of programmes</b>	10+1	<b>Auto sensor 45-65</b>	Yes
<b>Washing temperatures</b>	38, 45, 50, 55, 65, 70, 75 °C	<b>Mix</b>	Yes
<b>Soak</b>	Yes	<b>Quiet (-2 dB)</b>	Yes
<b>Express 27'</b>	Yes	<b>Intense</b>	Yes
<b>Crystal</b>	Yes	<b>Self clean</b>	Yes
<b>Full express - 60 minutes</b>	Yes	<b>Hygiene 99,9%</b>	Yes
<b>ECO</b>	Yes		

## Options



<b>Dry Assist+ option</b>	Yes	<b>1/2 load FlexiZone option</b>	Yes
<b>Delay timer option</b>	Up to 24 hours	<b>Special programs option</b>	Yes

## Baskets



<b>Basket colour</b>	Grey	<b>Sliding Guides Extra Glide</b>	Yes
<b>Basket components colour</b>	Grey	<b>Largest loadable dish in upper basket</b>	19,0 cm
<b>Handle</b>	In plastic on upper and lower basket	<b>Lower Basket</b>	With 2 foldable racks

<b>Upper Basket</b>	With 1 foldable rack	<b>Lower basket with anti-drip inserts</b>	Yes
<b>Glass holder</b>	Yes	<b>Largest loadable dish in lower basket</b>	35,0 cm
<b>Height adjustment of the upper basket</b>	On three levels (5 cm)	<b>Colour Inner Components</b>	Blue

## Technical Features



<b>Width (mm)</b>	598 mm	<b>Water supply</b>	Single; cold/hot water max. 60°C - energysave with hot water up to 35%
<b>Depth (mm)</b>	550 mm	<b>Max water hardness</b>	100°FH;58°dH
<b>Display type</b>	LED display (3 digit)	<b>Drying system</b>	Natural condenser drying, with Dry Assist + automatic door opening system at the end of the cycle
<b>Product Height (mm)</b>	858 mm	<b>Steam protection</b>	In plastic
<b>Watersave system</b>	Yes	<b>Tube material</b>	Stainless steel
<b>Controls</b>	Electronic	<b>Filter</b>	Stainless steel
<b>Display</b>	Delayed start, Programme time indicator	<b>Concealed heating element</b>	Yes
<b>Programme graphics</b>	Symbols	<b>Hinges</b>	Self balancing, Sliding, FLEXIFIT
<b>Salt light indicator</b>	Light	<b>Min. and max. frontal panel weight</b>	2,5 - 10 kg
<b>Rinse aid indicator</b>	Light	<b>Min. and max plinth height</b>	50 - 215 mm
<b>End of cycle indicator</b>	ActiveLight	<b>Adjustable feet</b>	7cm, from 860 to 930 mm
<b>Washing system</b>	Planetarium	<b>Additional gaskets</b>	Yes, with stainless steel plate
<b>Third spray arm</b>	Single	<b>Back cover</b>	Yes
<b>Water softener</b>	With electronic setting	<b>Depth of dishwasher with open door (mm)</b>	1168
<b>Turbidity sensor</b>	Yes	<b>Back feet adjustable from front</b>	Yes
<b>Aquatest</b>		<b>Top cover</b>	In plastic
<b>Flood protection system</b>	Total Acquastop		

## Performance / Energy Label - Reg. 2019

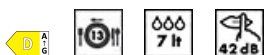

<b>Energy Efficiency Class</b>	D	<b>Programme duration</b>	3:40 h:min
<b>Energy consumption [per 100 cycles, based on the eco programme]</b>	81 kWh	<b>Airborne acoustical noise emissions</b>	42 dB(A) re 1 pW
<b>Rated capacity (ps)</b>	13	<b>Airborne acoustical noise emission class</b>	B
<b>Water consumption [per cycle]</b>	7.0 litres	<b>Energy efficiency Index (EEI)</b>	48.4

## Electrical Connection

---

<b>Plug</b>	(F;E) Schuko	<b>Frequency (Hz)</b>	50 Hz
<b>Connected power</b>	1800 W	<b>Type of connection</b>	Single-phase
<b>Current</b>	10 A	<b>Power supply cable length</b>	140 cm
<b>Voltage</b>	220-240 V		

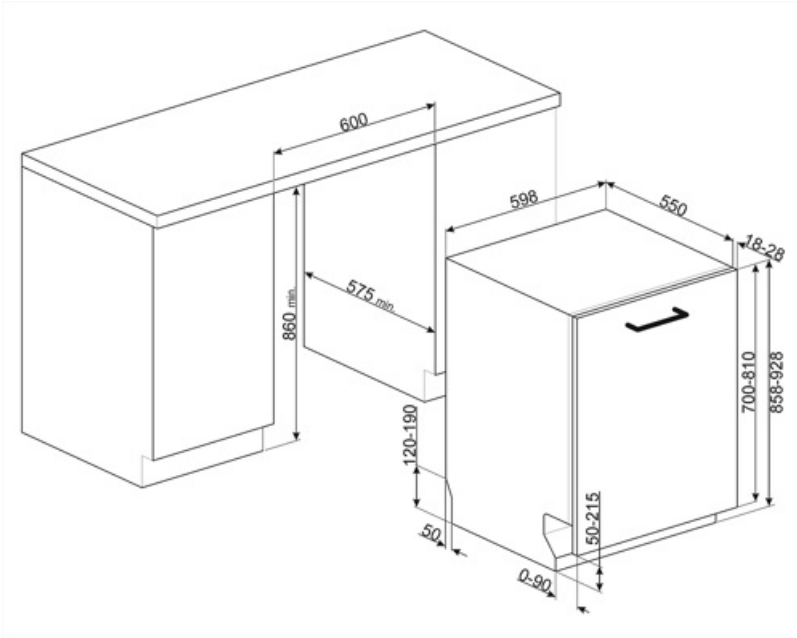

## Compatible Accessories



**KIT86PORTAN-1**



**KIT86PORTX-1**



**KIT86PORTWH-1**



**KITFLEXI**

Kit for 60cm dishwashers with FlexiFit hinges for door panel weight >11 kg (max 15 kg 82 cm and 13,5 kg 86 cm)

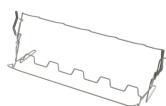

**KITGH**

Kit glass holder. It has to be fitted on the first basket but only if there are foldable racks



**KITPL60B**

Toe-kick Kit in White colour with adjustable height and deepness. Can be installed over all the fully integrated and underbench models with variable fulcrum or flexifit hinges.



**KITPL60N**

Toe-kick Kit in Black colour with adjustable height and deepness. Can be installed over all the fully integrated and underbench models with variable fulcrum or flexifit hinges.



**KITPL60X**





















Toe-kick Kit in Stainless Steel with adjustable height and deepness. Can be fitted over all the fully integrated and underbench models with variable fulcrum or flexifit hinges.













**KITPLV2**

Kit extension for dishwasher and washing machine: lenght mt. 2

## Symbols glossary

 <p>Activelight is an led light which projects a red spot onto the floor beneath the dishwasher when the appliance is in use.</p>	 <p>The Aquatest sensor is an electronic sensor that measures the degree of water transparency at the end of the initial soaking phase. Based on the values measured, the sensor sets the most suitable programme, thus obtaining the best washing results with the minimum amount of water.</p>
 <p>To improve the drying of dishes without leaving stains.</p>	 <p>86 cm high</p>
 <p>Delay Timer: Option to postpone the start of the desired programme by up to 24 hours in order to programme the dishwasher to run at the desired time.</p>	 <p>FlexiDuo: The FlexiDuo 3rd cutlery basket allows you to arrange cutlery or small cups, ladles, or bulky utensils however you like: it consists of two separate and moveable modules.</p>
 <p>The FlexiFit hinges allow the kitchen panel to slide over the dishwasher door, allowing a minimum kitchen plinth height of 5 cm.</p>	 <p>FlexiZone: The ½ load flexizone allows you to wash a reduced load saving energy, water and time and there are no restrictions on where the items are placed.</p>
 <p>The ExtraGlide guides system makes the second basket run even smoother and softer. It facilitates movement even when fully loaded, and thanks to the increased excursion, facilitates the insertion of dishes into the basket.</p>	 <p>Noise Level: Excellent insulation and special devices keep noise to a minimum.</p>
 <p>The Planetarium washing system, with high rotations per minute, guarantees complete coverage of the tank, thanks to the simultaneous rotation of base and sprayers, and excellent washing results.</p>	 <p>Auto 45°- 65°: The auto programme regulates the length of a cycle depending on the need for a pre-wash and the number of rinses required.</p>
 <p>Crystals: The Crystals programme is dedicated to delicate dishes such as glasses and china.</p>	 <p>Eco: Eco, this economic wash programme uses a low amount of water and energy in order to provide the most environmentally friendly cleaning option.</p>
 <p>Mix: The Mix programme is suitable for mixed crockery and everyday pots and pans, without any particular incrustation.</p>	 <p>Soak programme: The soak programme provides a rinse to prevent dirt from drying.</p>
 <p>Express 27': The Express 27' programme is a quick wash cycle, at low temperatures, for lightly soiled dishes.</p>	 <p>Ultraclean: The Ultraclean option performs a final rinse at a high temperature of 70°C eliminating virtually all bacteria.</p>
 <p>13 place settings: Number of place settings.</p>	 <p>Total Acquastop: In addition to the partial Acquastop protection present in all Smeg dishwashers, some models have an electronic device fitted to the water intake hose, which monitors water levels in the machine, detects leaks in the hose and switches off the water supply immediately when necessary.</p>

-  System WaterSave ensures the best washing results with minimal water consumption depending on the model of dishwasher.
-  Dishwasher cleaning cycle. The cycle should be started with the machine empty, without dishes. It is recommended to run the program every 2-3 months, using special dishwasher detergents.
-  Allows you to enable additional programs when selected together with any wash cycle. After having selected the required wash cycle, press the button (
-  Energy efficiency class D
-  The work aimed at continuous improvement has allowed the creation of the second generation of the Inverter motor 2.0, characterised by greater efficiency and durability over time, which allows very high performance and a lower energy consumption and noise level.
-  Quick wash cycle for normally soiled mixed loads such as dishes and pans, even with dried-on residues. Dishes are washed and dried in 60 minutes.
-  SILENT: Wash cycle suitable for normally soiled dishes, even with dried-on residues. Ensures maximum noise reduction and is therefore ideal if you wish to run it during the night.
-  The Dry Assist + option, in addition to saving energy, ensures perfect drying of the dishes by opening the door automatically at the end of the washing cycle.
-  HYGIENE 99.9% High-temperature washing programme. The 75° rinse guarantees the removal of 99.9% of germs and bacteria.
- 

## Benefit (TT)

---

### Active Light

Maximum control thanks to the light projected on the floor that indicates when the dishwasher is running and when the cycle is complete

Smeg dishwashers equipped with ActiveLight signal the appliance's activity status by projecting a light on the floor while the cycle is running. The light goes out at the end of the cycle, signalling that the dishwasher can be unloaded.

### FlexiDuo

The flexible third basket provides additional space, adapting to the load to accommodate various types of dishes, ensuring optimal organization and efficient use of interior capacity

The third FlexiDuo basket consists of two separate sections that can be handled independently of each other, stacked and/or removed, offering loading flexibility for every need. Depending on the arrangement, it allows cups, tall glasses, bulky utensils and pots and pans to be placed in the upper basket.

### Planetarium Wash System

Full and deep wash coverage thanks to the advanced movement of the spray arm, an innovation patented by Smeg

Smeg's patented Planetarium Wash System guarantees impeccable cleaning. With a simultaneous double movement of the sprayer and 65 rotations per minute, it reaches every nook and cranny for extraordinary results. Dishes, glasses and utensils will be perfectly clean in no time. An intelligent system where efficiency and style meet, delivering brilliant results effortlessly.

### Flexifit hinge system

Smooth-running door for optimal integration into the kitchen design

The height of the plinth can vary from 5 cm to 21.5 cm, allowing it to fit perfectly into the cabinet. Thanks to this solution, the dishwasher blends harmoniously into its surroundings, with the door and plinth perfectly aligned with the other kitchen furniture.

### Extra Glide Telescopic Guides

Smoother and more stable loading and unloading operations

Extra Glide telescopic guides ensure smooth and safe extraction of the upper basket, even with heavy loads. The telescopic design ensures smooth, stable and silent movement, improving ergonomics and convenience. Ideal for optimising space and ease of use, they combine durability and comfort in every washing operation.

### DryAssist+

The Dry Assist+ system of automatic door opening at the end of the cycle ensures fast and energy-efficient drying