

STL324AQLH

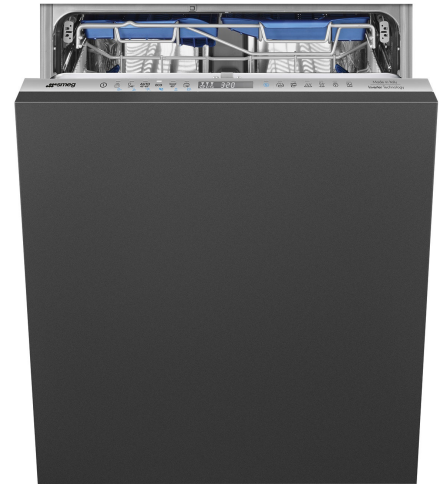

Product Family	Dishwashers
Commercial width	60 cm
Commercial height	86 cm
Installation	Fully-integrated built-in
Kitchen panel	Not supplied
N° baskets	3, FlexiDuo with Easy Glide
Motor	Inverter 2.0
EAN code	8017709338824



Programs



N. of programmes	12+2	Auto sensor 45-65	Yes
Washing temperatures	38, 45, 50, 55, 65, 70, 75 °C	Mix	Yes
Soak	Yes	Quiet (-2 dB)	Yes
Express 27'	Yes	Intense	Yes
Crystal	Yes	Self clean	Yes
Full express - 60 minutes	Yes	Hygiene 99,9%	Yes
ECO	Yes	Delicate	Yes
Green express	Yes	Trays	Yes

Options



Dry Assist+ option	Yes	Special programs option	Yes
Delay timer option	Up to 24 hours	Clean&Shine option	Yes
1/2 load FlexiZone option	Yes		

Baskets



Basket colour	Grey	Sliding Guides Extra	Yes
Basket components colour	Grey	Glide	

Handle	In plastic with stainless steel insert on upper and lower basket	Largest loadable dish in upper basket	19,0 cm
Upper Basket	With 3 foldable racks	Lower Basket	With 4 foldable racks
Glass holder	Yes	Lower basket with anti-drip inserts	Yes
Height adjustment of the upper basket	On three levels (5 cm)	Largest loadable dish in lower basket	35,0 cm
		Colour Inner Components	Blue

Technical Features



Width (mm)	598 mm	Max water hardness	100°fH;58°dH
Depth (mm)	550 mm	Drying system	Natural condenser drying, with Dry Assist + automatic door opening system at the end of the cycle
Display type	LED display	Steam protection	In plastic
Product Height (mm)	858 mm	Tube material	Stainless steel
Controls	Electronic touch control	Filter	Stainless steel
Display	Delayed start, Programme time indicator, Consumptions	Concealed heating element	Yes
Programme graphics	Symbols	Hinges	Self balancing, Sliding, FLEXIFIT
Salt light indicator	Light	Min. and max. frontal panel weight	2,5 - 10 kg
Rinse aid indicator	Light	Min. and max plinth height	50 - 215 mm
End of cycle indicator	ActiveLight	Can be installed in-column	Yes, with siphon
Auto switch-off	Yes	Adjustable feet	7 cm, from 860 to 930 mm
Washing system	Planetarium	Additional gaskets	Yes, with stainless steel plate
Third spray arm	Single	Back cover	Yes
Water softener	With electronic setting	Depth of dishwasher with open door (mm)	1168 mm
Turbidity sensor Aquatest	Yes	Back feet adjustable from front	Yes
Flood protection system	Total Acquastop	Top cover	In plastic
Water supply	Single; cold/hot water max. 60°C - energysave with hot water up to 35%		

Performance / Energy Label - Reg. 2019



Energy Efficiency Class	A	Programme duration	4:35 h:min
Energy consumption [per 100 cycles, based on the eco programme]	54 kWh	Airborne acoustical noise emissions	42 dB(A) re 1 pW
Rated capacity (ps)	14	Airborne acoustical noise emission class	B
Water consumption [per cycle]	10.5 litres	Energy efficiency Index (EEI)	31.8

Electrical Connection

Connected power	1800 W	Type of connection	Single-phase
Current	10 A	Power supply cable length	140 cm
Voltage	220-240 V	Plug	(F;E) Schuko
Frequency (Hz)	50 Hz		

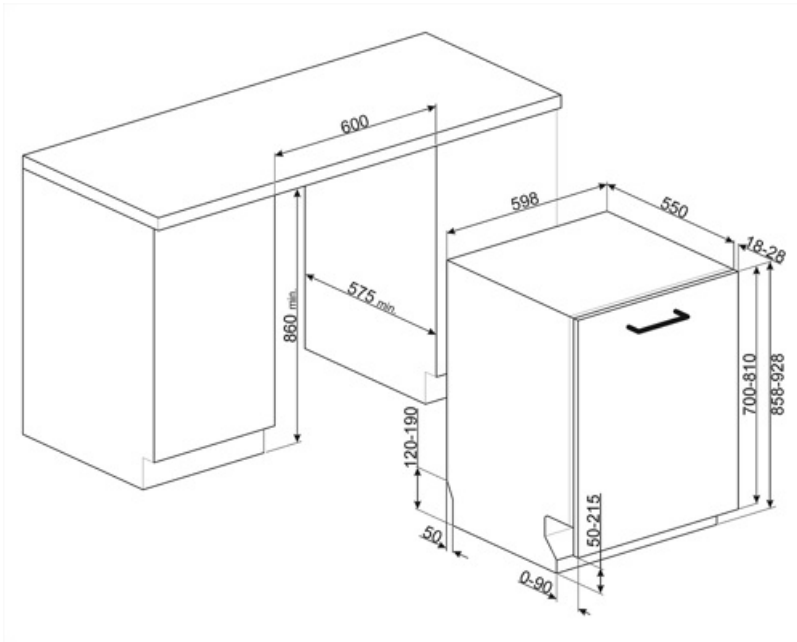

Compatible Accessories



KIT86CX-1

Door kit, stainless steel, Canali handle, fully integrated dishwasher h.86 cm
Compatible with models with Flexifit and fixed fulcrum hinges.



KIT86PORTRD



KIT86PORTX-1



KIT86SPRMW



KIT86PORTAN-1



KIT86PORTWH-1



KIT86SPRAN



KIT86SPRX



KITFLEXI

Kit for 60cm dishwashers with FlexiFit hinges for door panel weight >11 kg (max 15 kg 82 cm and 13,5 kg 86 cm)

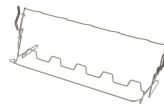

KITGH

Kit glass holder. It has to be fitted on the first basket but only if there are foldable racks



KITPL60B

Toekick Kit in White colour with adjustable height and deepness. Can be installed over all the fully integrated and underbench models with variable fulcrum or flexifit hinges.



KITPL60N

Toekick Kit in Black colour with adjustable height and deepness. Can be installed over all the fully integrated and underbench models with variable fulcrum or flexifit hinges.



KITPL60X























Toekick Kit in Stainless Steel with adjustable height and deepness. Can be fitted over all the fully integrated and underbench models with variable fulcrum or flexifit hinges.

















KITPLV2

Kit extension for dishwasher and washing machine: lenght mt. 2

Symbols glossary

 <p>Activelight is an led light which projects a red spot onto the floor beneath the dishwasher when the appliance is in use.</p>	 <p>The Aquatest sensor is an electronic sensor that measures the degree of water transparency at the end of the initial soaking phase. Based on the values measured, the sensor sets the most suitable programme, thus obtaining the best washing results with the minimum amount of water.</p>
 <p>To improve the drying of dishes without leaving stains.</p>	 <p>Energy efficiency class A</p>
 <p>Clean&Shine option: For perfect cleaning results, this option adds an extra rinse to the wash cycle, which also gives the dishes a higher gloss.</p>	 <p>Installation in column: Installation in column.</p>
 <p>86 cm high</p>	 <p>Delay Timer: Option to postpone the start of the desired programme by up to 24 hours in order to programme the dishwasher to run at the desired time.</p>
 <p>The Dry Assist + option, in addition to saving energy, ensures perfect drying of the dishes by opening the door automatically at the end of the washing cycle.</p>	 <p>FlexiDuo: The FlexiDuo 3rd cutlery basket allows you to arrange cutlery or small cups, ladles, or bulky utensils however you like: it consists of two separate and moveable modules.</p>
 <p>The FlexiFit hinges allow the kitchen panel to slide over the dishwasher door, allowing a minimum kitchen plinth height of 5 cm.</p>	 <p>FlexiZone: The ½ load flexizone allows you to wash a reduced load saving energy, water and time and there are no restrictions on where the items are placed.</p>
 <p>The ExtraGlide guides system makes the second basket run even smoother and softer. It facilitates movement even when fully loaded, and thanks to the increased excursion, facilitates the insertion of dishes into the basket.</p>	 <p>Noise Level: Excellent insulation and special devices keep noise to a minimum.</p>
 <p>The Planetarium washing system, with high rotations per minute, guarantees complete coverage of the tank, thanks to the simultaneous rotation of base and sprayers, and excellent washing results.</p>	 <p>Auto 45°- 65°: The auto programme regulates the length of a cycle depending on the need for a pre-wash and the number of rinses required.</p>
 <p>Crystals: The Crystals programme is dedicated to delicate dishes such as glasses and china.</p>	 <p>Delicate: Delicate washing program is designed for delicate dishes which are not heavily soiled.</p>
 <p>Eco: Eco, this economic wash programme uses a low amount of water and energy in order to provide the most environmentally friendly cleaning option.</p>	 <p>Mix: The Mix programme is suitable for mixed crockery and everyday pots and pans, without any particular incrustation.</p>
 <p>Soak programme: The soak programme provides a rinse to prevent dirt from drying.</p>	 <p>Express 27': The Express 27' programme is a quick wash cycle, at low temperatures, for lightly soiled dishes.</p>

-
- | | |
|--|---|
|  <p>Ultraclean: The Ultraclean option performs a final rinse at a high temperature of 70°C eliminating virtually all bacteria.</p> |  <p>14 place settings: Number of place settings.</p> |
|  <p>Total Acquastop: In addition to the partial Acquastop protection present in all Smeg dishwashers, some models have an electronic device fitted to the water intake hose, which monitors water levels in the machine, detects leaks in the hose and switches off the water supply immediately when necessary.</p> |  <p>Touch controls: Easy to use touch controls allow the appliance to be programmed at the touch of a button.</p> |
|  <p>System WaterSave ensures the best washing results with minimal water consumption depending on the model of dishwasher.</p> |  <p>GREEN EXPRESS Washing programme with low water and energy consumption.</p> |
|  <p>Quick wash cycle for normally soiled mixed loads such as dishes and pans, even with dried-on residues. Dishes are washed and dried in 60 minutes.</p> |  <p>Dishwasher cleaning cycle. The cycle should be started with the machine empty, without dishes. It is recommended to run the program every 2-3 months, using special dishwasher detergents.</p> |
|  <p>SILENT: Wash cycle suitable for normally soiled dishes, even with dried-on residues. Ensures maximum noise reduction and is therefore ideal if you wish to run it during the night.</p> |  <p>Allows you to enable additional programs when selected together with any wash cycle.</p> |
|  <p>Baking tray programme: for intensive cleaning of the oven trays. Place the trays in the lower basket of the dishwasher.</p> |  <p>HYGIENE 99.9% High-temperature washing programme. The 75° rinse guarantees the removal of 99.9% of germs and bacteria.</p> |
|  <p>The work aimed at continuous improvement has allowed the creation of the second generation of the Inverter motor 2.0, characterised by greater efficiency and durability over time, which allows very high performance and a lower energy consumption and noise level.</p> |  <p>B,7</p> |