

STL62124FR



| | |
|---------------------|-----------------------|
| Familie | Vaatwasser |
| Commerciële breedte | 60 cm |
| Nishoogte | 82 cm |
| Installatie | Volledig geïntegreerd |
| Aantal korven | 2 |
| EAN-code | 8017709244156 |



Programs



| | | | |
|--------------------|--|---------------------|----|
| Aantal programma's | 5 standaard + 4 Quick Time programma's | Normaal | Ja |
| Wastemperatuur | 38, 45, 50, 55, 65, 70 °C | ECO Quick | Ja |
| Weken | Ja | Delicate vaat, snel | Ja |
| Snel 27' | Ja | Normaal snel | Ja |
| Glas | Ja | Sterk en snel | Ja |
| Eco | Ja | Super | Ja |

Opties



| | | | |
|---|--|--------------------------------|----|
| Delay timer optie | Tot 24 uur, i.c.m. automatisch spoelen | Quick Time option | Ja |
| FlexiZone ½ (halve beladingsmogelijkheid) | Ja | Hyclean optie (Intensief 70°C) | Ja |
| FlexiTabs optie | Ja | | |

Korven



| | | | |
|-----------------------|------------------------|---------------------------------|---------------------|
| Kleur korven | Grijs | Onderkorf | 2 inklapbare rekken |
| Kleur korfcomponenten | Grijs | Onderkorf met anti-drup inserts | Ja |
| Handgreep | Op onder- en bovenkorf | | |
| Bovenkorf | Met vaste rekken | | |

| | | | |
|--|-----------|--|--|
| In hoogte verstelbare bovenkorf | 3 niveaus | Maximum afmetingen bord dat in onderste korf kan worden geladen | 30,0 cm |
| Maximum afmetingen bord dat in bovenste korf kan worden geladen | 23,5 cm | Kleur binnenonderdelen | Grijze inzetstukken voor valbescherming, grijzen handgrepen, rijs kunststof plaat voor plaatsing tweede mandje op drie niveaus, Groene sproeiarm |
| | | Bestekmandje | 13 couverts, schuivend |

Technische specificaties



| | | | |
|---------------------------------------|--|--|---|
| Breedte product | 598 mm | Overstroombeveiliging | Single Acquastop |
| Diepte product | 545 mm | Watertoevoer | Enkel; koud en warm water tot 60°C - energiebesparing tot 35% |
| Type display | 3 cijfers | | 100°FH;58°dH |
| Hoogte product | 818 mm | Maximale waterhardheid | |
| Bediening | Elektronisch | Droogsysteem | Natuurlijke condensatie |
| Display | Instelling Delay timer, Programma duur indicator, Resttijd indicatie | Stoombeveiliging | Van kunststof |
| | | Materiaal kuip | Roestvrij staal |
| Grafische weergave programma's | Symbolen | Filter | Roestvrij staal |
| Aan/uit indicator | Ja | Verborgene verwarmingselement | Ja |
| Zout indicator | Indicator (lampje) | Scharnieren | Self balancing, Sliding, FLEXIFIT |
| Glansspoelmiddel indicator | Indicator (lampje) | Min. en max. frontaal paneelgewicht | 2,5 - 11 kg |
| Indicator einde cyclus | Akoestisch signaal | Verstelbare voetjes | 7 cm, van 820 tot 890 mm |
| Wassysteem | Orbital | Diepte vaatwasser met open deur (mm) | 1146 |
| Derde sproeiarm | Enkel | Voetjes achterzijde vanaf de voorkant regelbaar | Ja |
| Waterontkalker | Elektronisch instelbaar | Bovenbedekking | Van kunststof |

Elektrische aansluiting

| | | | |
|-----------------------|--------------|-----------------------------|--------------|
| Stekker | (F;E) Schuko | Frequentie | 50 Hz |
| Aansluitwaarde | 1800 W | Type aansluiting | Single-phase |
| Stroom | 10 A | Lengte voedingskabel | 140 cm |
| Spanning | 220-240 V | | |

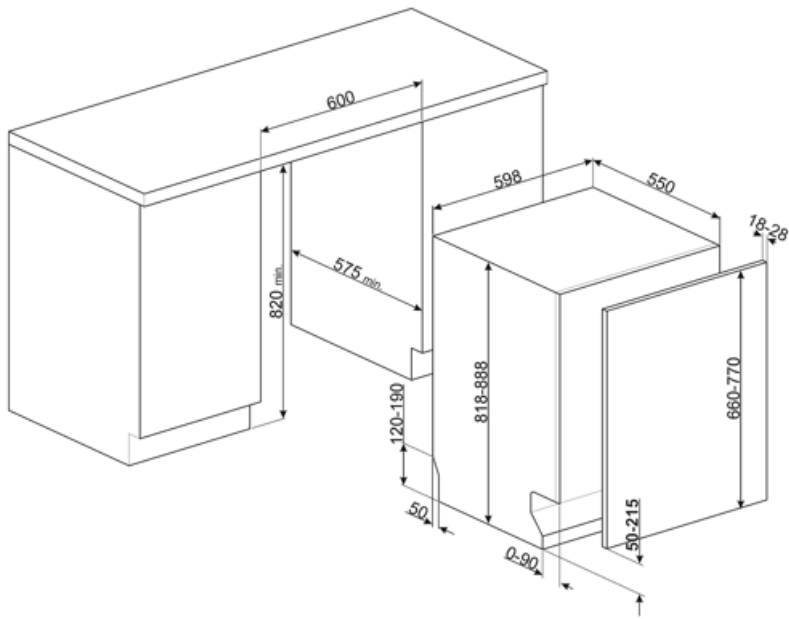

Accessoires niet inbegrepen



KITFLEXI

Kit for 60cm dishwashers with FlexiFit hinges for door panel weight >11 kg (max 15 kg 82 cm and 13,5 kg 86 cm)



KITPL60B

Toekick Kit in witte kleur met verstelbare hoogte en diepte. Kan worden geïnstalleerd over alle volledig geïntegreerde modellen en modellen onderbouw met variabel draaipunt of flexifit-scharnieren.

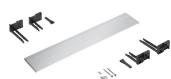

KITPL60X

Toekick Kit in roestvrij staal met verstelbare hoogte en diepte. Kan worden gemonteerd over alle volledig geïntegreerde modellen en onderbouw modellen met variabel draaipunt of flexifit-scharnieren.

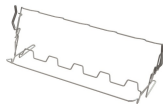

KITGH

Kit glazen houder. Deze moet op de eerste mand worden gemonteerd, maar alleen als er inklapbare rekken zijn



KITPL60N





















Toekick Kit in zwarte kleur met verstelbare hoogte en diepte. Kan worden geïnstalleerd over alle volledig geïntegreerde modellen en onderbouw modellen met variabel draaipunt of flexifit-scharnieren.



KITPLV2

Kit verlengstuk voor vaatwasser en wasmachine: lengte 2 mtr.

Symbols glossary (TT)

| | |
|---|---|
|  <p>A +: Energie-efficiëntieklasse A + helpt om tot 10% energie te besparen in vergelijking met klasse A. Maximale prestaties bij minimaal verbruik zijn gegarandeerd.</p> |  <p>Aquastop: Sommige vaatwassers van Smeg zijn uitgerust met een eenvoudige Aquastop: vlottersensor in de bodem die nodig is om te voorkomen dat er per ongeluk water in het apparaat lekt.</p> |
|  <p>To improve the drying of dishes without leaving stains.</p> |  <p>82 cm high</p> |
|  <p>Vertragingstimer: De uitgestelde timer kan de start van het programma tot 24 uur uitstellen.</p> |  <p>The FlexiFit hinges allow the kitchen panel to slide over the dishwasher door, allowing a minimum kitchen plinth height of 5 cm.</p> |
|  <p>Ideal for multi-function detergents, this option allows washing to be optimised, with full benefits from the combined-action tablets. When this option is activated, any salt and rinse aid is used.</p> |  <p>FlexiZone: The ½ load flexizone allows you to wash a reduced load saving energy, water and time and there are no restrictions on where the items are placed.</p> |
|  <p>Hyclean: When the HYCLEAN option is selected, the dishwasher performs a final 10 minute rinse at a high temperature of 70°C, eliminating virtually all bacteria to achieve the highest possible standards of cleanliness. The Hyclean option can be selected with almost all cycles at temperatures above 50°C.</p> |  <p>Noise Level: Excellent insulation and special devices keep noise to a minimum.</p> |
|  <p>Orbital wash system distributes water evenly throughout the 60cm dishwasher cavity, directing water with precision to ensure an excellent wash.</p> |  <p>Delicate Quick: Program Delicate Quick is suitable for quick washing of delicate dishes.</p> |
|  <p>Eco: Eco, this economic wash programme uses a low amount of water and energy in order to provide the most environmentally friendly cleaning option.</p> |  <p>Eco: Eco, this economic wash programme uses a low amount of water and energy in order to provide the most environmentally friendly cleaning option.</p> |
|  <p>Normal Quick: Program Normal Quick is suitable for quick washing of mixed dishes, for everyday use.</p> |  <p>Soak programme: The soak programme provides a rinse to prevent dirt from drying.</p> |
|  <p>PRG_STRONG_72dpi</p> |  <p>Strong&Fast: This special programme takes less than 1 hour to eliminate the most stubborn dirt and dried on residues.</p> |
|  <p>13 place settings: Number of place settings.</p> |  <p>System WaterSave ensures the best washing results with minimal water consumption depending on the model of dishwasher.</p> |