

STL7322BL



Familie	Vaatwasser
Commerciële breedte	60 cm
Nishoogte	82 cm
Installatie	Volledig geïntegreerd
Deur paneel	Niet meegeleverd
Aantal korven	3, FlexiDuo
Motor	Inverter 2.0
EAN-code	8017709357382



Programs



Aantal programma's	10+1	Auto sensor 45-65	Ja
Wastemperatuur	38, 45, 50, 55, 65, 70, 75 °C	Mix	Ja
Weken	Ja	Stil (-2dB)	Ja
Snel 27'	Ja	Intensief	Ja
Krystal	Ja	Zelf reinigen	Ja
Snel - Volledig 60'	Ja	Hygiëne 99,9%	Ja
Eco	Ja		

Opties



Dry Assist + opties	Ja	FlexiZone ½ (halve beladingsmogelijkheid)	Ja
Delay timer optie	Tot 24 uur, i.c.m. automatisch spoelen	Optie speciale programma's	Ja

Korven



Kleur korven	Grijs	Onderkorf	2 inklapbare rekken
Kleur korfcomponenten	Grijs	Lower basket accessories	MultiLoad
Handgreep	Op onder- en bovenkorf	Onderkorf met anti-drup inserts	Ja
Bovenkorf	Met 1 opvouwbaar rek		
In hoogte verstelbare bovenkorf	3 niveaus		

Maximum afmetingen
bord dat in bovenste
korf kan worden
geladen 19,0 cm

Maximum afmetingen
bord dat in onderste
korf kan worden
geladen 30,0 cm
Kleur binnenonderdelen Sage Leaf

Technische specificaties



Breedte product 598 mm
Diepte product 545 mm
Type display 3 cijfers
Hoogte product 818 mm
Bediening Elektronisch
Display Instelling Delay timer,
Programma duur indicator
**Grafische weergave
programma's** Symbolen
Aan/uit indicator Ja
Zout indicator Indicator (lampje)
**Glansspoelmiddel
indicator** Indicator (lampje)
Indicator einde cyclus ActiveLight
Auto switch-off Yes
Wassysteem Orbital
Derde sproeiarm Enkel
Waterontkalker Elektronisch instelbaar
Aquatest sensor Ja

Overstroombeveiliging Total Acquastop
Watertoevoer Enkel; koud en warm water
tot 60°C - energiebesparing
tot 35%
**Maximale
waterhardheid** 100°FH;58°dH
Droogstelsysteem Natuurlijk condensor drogen
met Dry Assist +
automatische
deuropeningssysteem aan
het einde van de cyclus
Stoombeveiliging Van kunststof
Materiaal kuip Roestvrij staal
Filter Roestvrij staal
**Verborgen
verwarmingselement** Ja
Scharnieren Self balancing, Sliding,
FLEXIFIT
**Min. en max. frontaal
paneelgewicht** 2,5 - 11 kg
Min. en max plintheogte 50 - 215 mm
Verstelbare voetjes 7 cm, van 820 tot 890 mm
Back cover Ja
**Diepte vaatwasser met
open deur (mm)** 1146 mm
**Voetjes achterzijde
vanaf de voorkant
regelbaar** Ja
Bovenbedekking Van kunststof

Performance / Energy Label - Reg. 2019

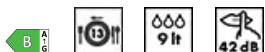

**Energie-efficiëntieklasse B
(wascyclus)**
**Energy consumption
[per 100 cycles, based
on the eco programme]** 63 kWh
Nominale capaciteit (ps) 13
**Water verbruik (per
cyclus)** 9.0 litres

Programmaduur 4:25 h:min
Geluidsniveau 42 dB(A) re 1 pW
**Akoestisch
geluidsemissieklasse** B
**Energy efficiency Index
(EEI)** 37.9

Elektrische aansluiting

Aansluitwaarde 1800 W
Stroom 10 A
Spanning 220-240 V
Frequentie 50 Hz

Type aansluiting Single-phase
Lengte voedingskabel 140 cm
Stekker (F;E) Schuko



Compatibele Accessoires



KIT82CN



KIT82SPRAN



KIT82SPRX



KIT82CX



KIT82SPRMW



KITFLEXI

Kit for 60cm dishwashers with FlexiFit hinges for door panel weight >11 kg (max 15 kg 82 cm and 13,5 kg 86 cm)



KITGH

Kit glazen houder. Deze moet op de eerste mand worden gemonteerd, maar alleen als er inklapbare rekken zijn



KITPL60B

Toekick Kit in witte kleur met verstelbare hoogte en diepte. Kan worden geïnstalleerd over alle volledig geïntegreerde modellen en modellen onderbouw met variabel draaipunt of flexifit-scharnieren.



KITPL60N

Toekick Kit in zwarte kleur met verstelbare hoogte en diepte. Kan worden geïnstalleerd over alle volledig geïntegreerde modellen en onderbouw modellen met variabel draaipunt of flexifit-scharnieren.



KITPL60X























Toekick Kit in roestvrij staal met verstelbare hoogte en diepte. Kan worden gemonteerd over alle volledig geïntegreerde modellen en onderbouw modellen met variabel draaipunt of flexifit-scharnieren.



KITPLV2

Kit verlengstuk voor vaatwasser en wasmachine: lengte 2 mtr.

Symbols glossary

	<p>Activelight is een led die een rode stip projecteert op de vloer onder de vaatwasser als het apparaat in gebruik is</p>		<p>Aquatest meet de helderheid van het water tijdens een automatisch programma en zorgt automatisch voor een minimaal verbruik van water en energie</p>
	<p>To improve the drying of dishes without leaving stains.</p>		<p>82 cm high</p>
	<p>Vertragingstimer: De uitgestelde timer kan de start van het programma tot 24 uur uitstellen.</p>		<p>FlexiDuo: The FlexiDuo 3rd cutlery basket allows you to arrange cutlery or small cups, ladles, or bulky utensils however you like: it consists of two separate and moveable modules.</p>
	<p>The FlexiFit hinges allow the kitchen panel to slide over the dishwasher door, allowing a minimum kitchen plinth height of 5 cm.</p>		<p>FlexiZone: The ½ load flexizone allows you to wash a reduced load saving energy, water and time and there are no restrictions on where the items are placed.</p>
	<p>Noise Level: Excellent insulation and special devices keep noise to a minimum.</p>		<p>Orbital wash system distributes water evenly throughout the 60cm dishwasher cavity, directing water with precision to ensure an excellent wash.</p>
	<p>Auto 45°- 65°: The auto programme regulates the length of a cycle depending on the need for a pre-wash and the number of rinses required.</p>		<p>Crystals: The Crystals programme is dedicated to delicate dishes such as glasses and china.</p>
	<p>Eco: Eco, this economic wash programme uses a low amount of water and energy in order to provide the most environmentally friendly cleaning option.</p>		<p>Mix: The Mix programme is suitable for mixed crockery and everyday pots and pans, without any particular incrustation.</p>
	<p>Soak programme: The soak programme provides a rinse to prevent dirt from drying.</p>		<p>Express 27': The Express 27' programme is a quick wash cycle, at low temperatures, for lightly soiled dishes.</p>
	<p>Ultraclean: The Ultraclean option performs a final rinse at a high temperature of 70°C eliminating virtually all bacteria.</p>		<p>13 place settings: Number of place settings.</p>
	<p>Total Acquastop: In addition to the partial Acquastop protection present in all Smeg dishwashers, some models have an electronic device fitted to the water intake hose, which monitors water levels in the machine, detects leaks in the hose and switches off the water supply immediately when necessary.</p>		<p>System WaterSave ensures the best washing results with minimal water consumption depending on the model of dishwasher.</p>
	<p>Quick wash cycle for normally soiled mixed loads such as dishes and pans, even with dried-on residues. Dishes are washed and dried in 60 minutes.</p>		<p>Dishwasher cleaning cycle. The cycle should be started with the machine empty, without dishes. It is recommended to run the program every 2-3 months, using special dishwasher detergents.</p>



SILENT: Wash cycle suitable for normally soiled dishes, even with dried-on residues. Ensures maximum noise reduction and is therefore ideal if you wish to run it during the night.



The Dry Assist + option, in addition to saving energy, ensures perfect drying of the dishes by opening the door automatically at the end of the washing cycle.



HYGIENE 99.9% High-temperature washing programme. The 75° rinse guarantees the removal of 99.9% of germs and bacteria.



Allows you to enable additional programs when selected together with any wash cycle.



Energy efficiency class B



The work aimed at continuous improvement has allowed the creation of the second generation of the Inverter motor 2.0, characterised by greater efficiency and durability over time, which allows very high performance and a lower energy consumption and noise level.

