

STL7324AQL



| | |
|-------------------|-----------------------------|
| Product Family | Dishwashers |
| Commercial width | 60 cm |
| Commercial height | 82 cm |
| Installation | Fully-integrated built-in |
| Kitchen panel | Not supplied |
| N° baskets | 3, FlexiDuo with Easy Glide |
| Motor | Inverter 2.0 |
| EAN code | 8017709357405 |



Programs



| | | | |
|---------------------------|-------------------------------|-------------------|-----|
| N. of programmes | 12+2 | Auto sensor 45-65 | Yes |
| Washing temperatures | 38, 45, 50, 55, 65, 70, 75 °C | Mix | Yes |
| Soak | Yes | Quiet (-2 dB) | Yes |
| Express 27' | Yes | Intense | Yes |
| Crystal | Yes | Self clean | Yes |
| Full express - 60 minutes | Yes | Hygiene 99,9% | Yes |
| ECO | Yes | Delicate | Yes |
| Green express | Yes | Trays | Yes |

Options



| | | | |
|---------------------------|----------------|----------------------------|-----|
| Dry Assist+ option | Yes | Intensive wash zone option | |
| Delay timer option | Up to 24 hours | Special programs option | Yes |
| 1/2 load FlexiZone option | Yes | Clean&Shine option | Yes |

Baskets



| | | | |
|--------------------------|------|---------------------------------------|-----------------------|
| Basket colour | Grey | Largest loadable dish in upper basket | 19,0 cm |
| Basket components colour | Grey | Lower Basket | With 4 foldable racks |

| | | | |
|--|--|--|------------------------------------|
| Handle | In plastic with stainless steel insert on upper and lower basket | Lower basket accessories | MultiLoad, ProFlex Holder, WinePro |
| Upper Basket | With 3 foldable racks | Lower basket with anti-drip inserts | Yes |
| Height adjustment of the upper basket | On three levels (5 cm) | Largest loadable dish in lower basket | 30,0 cm |
| Sliding Guides Extra Glide | Yes | Colour Inner Components | Sage Leaf |

Technical Features



| | | | |
|----------------------------------|---|--|---|
| Width (mm) | 598 mm | Water supply | Single; cold/hot water max. 60°C - energysave with hot water up to 35% |
| Depth (mm) | 545 mm | Max water hardness | 100°FH;58°dH |
| Display type | LED display | Drying system | Natural condenser drying, with Dry Assist + automatic door opening system at the end of the cycle |
| Product Height (mm) | 818 mm | Steam protection | In plastic |
| Controls | Electronic touch control | Tube material | Stainless steel |
| Display | Delayed start, Programme time indicator, Consumptions | Filter | Stainless steel |
| Programme graphics | Symbols | Concealed heating element | Yes |
| On/off indicator | Yes | Hinges | Self balancing, Sliding, FLEXIFIT |
| Salt light indicator | Light | Min. and max. frontal panel weight | 2,5 - 11 kg |
| Rinse aid indicator | Light | Min. and max plinth height | 50 - 215 mm |
| End of cycle indicator | ActiveLight | Can be installed in-column | Yes, with siphon |
| Auto switch-off | Yes | Adjustable feet | 7 cm, from 820 to 890 mm |
| Washing system | Planetarium | Additional gaskets | Yes, with stainless steel plate |
| Third spray arm | Single | Back cover | Yes |
| Water softener | With electronic setting | Depth of dishwasher with open door (mm) | 1146 mm |
| Turbidity sensor Aquatest | Yes | Back feet adjustable from front | Yes |
| Flood protection system | Total Acquastop | Top cover | In plastic |

Performance / Energy Label - Reg. 2019

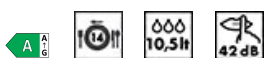

| | | | |
|--|--------|---|------------------|
| Energy Efficiency Class | A | Programme duration | 4:35 h:min |
| Energy consumption [per 100 cycles, based on the eco programme] | 54 kWh | Airborne acoustical noise emissions | 42 dB(A) re 1 pW |
| Rated capacity (ps) | 14 | Airborne acoustical noise emission class | B |

Water consumption [per 10.5 litres cycle]

Energy efficiency Index (EEI) 31.8

Electrical Connection

Connected power 1800 W
 Current 10 A
 Voltage 220-240 V
 Frequency (Hz) 50 Hz

Type of connection Single-phase
 Power supply cable length 140 cm
 Plug (F;E) Schuko

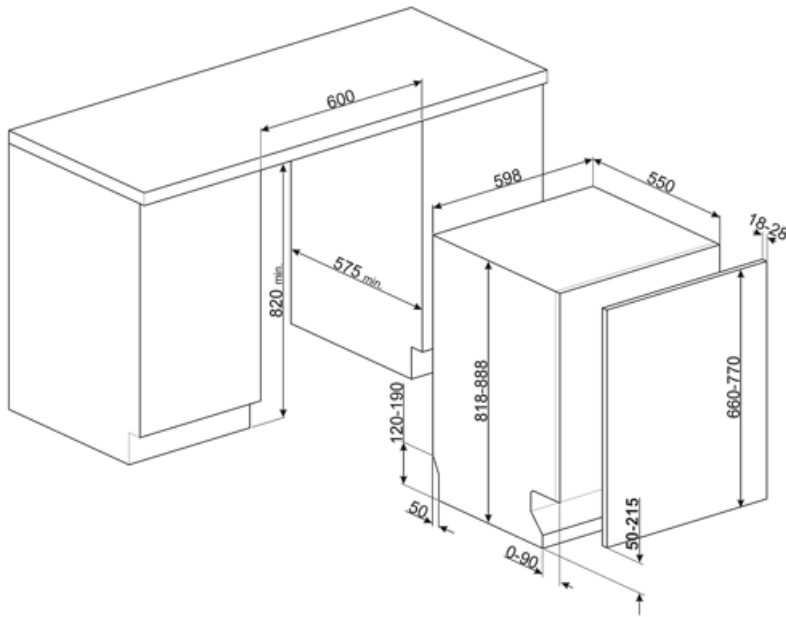

Compatible Accessories



KIT82CN



KIT82SPRAN



KIT82SPRX



KIT82CX



KIT82SPRMW



KITFLEXI

Kit for 60cm dishwashers with FlexiFit hinges for door panel weight >11 kg (max 15 kg 82 cm and 13,5 kg 86 cm)



KITGH

Kit glass holder. It has to be fitted on the first basket but only if there are foldable racks



KITPL60B

Toe-kick Kit in White colour with adjustable height and deepness. Can be installed over all the fully integrated and underbench models with variable fulcrum or flexifit hinges.



KITPL60N

Toe-kick Kit in Black colour with adjustable height and deepness. Can be installed over all the fully integrated and underbench models with variable fulcrum or flexifit hinges.



KITPL60X























Toe-kick Kit in Stainless Steel with adjustable height and deepness. Can be fitted over all the fully integrated and underbench models with variable fulcrum or flexifit hinges.

















KITPLV2

Kit extension for dishwasher and washing machine: lenght mt. 2

Symbols glossary

| | |
|--|---|
|  <p>Activelight is an led light which projects a red spot onto the floor beneath the dishwasher when the appliance is in use.</p> |  <p>The Aquatest sensor is an electronic sensor that measures the degree of water transparency at the end of the initial soaking phase. Based on the values measured, the sensor sets the most suitable programme, thus obtaining the best washing results with the minimum amount of water.</p> |
|  <p>To improve the drying of dishes without leaving stains.</p> |  <p>Energy efficiency class A</p> |
|  <p>Clean&Shine option: For perfect cleaning results, this option adds an extra rinse to the wash cycle, which also gives the dishes a higher gloss.</p> |  <p>Installation in column: Installation in column.</p> |
|  <p>82 cm high</p> |  <p>Delay Timer: Option to postpone the start of the desired programme by up to 24 hours in order to programme the dishwasher to run at the desired time.</p> |
|  <p>The Dry Assist + option, in addition to saving energy, ensures perfect drying of the dishes by opening the door automatically at the end of the washing cycle.</p> |  <p>FlexiDuo: The FlexiDuo 3rd cutlery basket allows you to arrange cutlery or small cups, ladles, or bulky utensils however you like: it consists of two separate and moveable modules.</p> |
|  <p>The FlexiFit hinges allow the kitchen panel to slide over the dishwasher door, allowing a minimum kitchen plinth height of 5 cm.</p> |  <p>FlexiZone: The 1/2 load flexizone allows you to wash a reduced load saving energy, water and time and there are no restrictions on where the items are placed.</p> |
|  |  <p>GREEN EXPRESS Washing programme with low water and energy consumption.</p> |
|  <p>The ExtraGlide guides system makes the second basket run even smoother and softer. It facilitates movement even when fully loaded, and thanks to the increased excursion, facilitates the insertion of dishes into the basket.</p> |  <p>The work aimed at continuous improvement has allowed the creation of the second generation of the Inverter motor 2.0, characterised by greater efficiency and durability over time, which allows very high performance and a lower energy consumption and noise level.</p> |
|  <p>Noise Level: Excellent insulation and special devices keep noise to a minimum.</p> |  <p>The Planetarium washing system, with high rotations per minute, guarantees complete coverage of the tank, thanks to the simultaneous rotation of base and sprayers, and excellent washing results.</p> |
|  <p>Auto 45°- 65°: The auto programme regulates the length of a cycle depending on the need for a pre-wash and the number of rinses required.</p> |  <p>Crystals: The Crystals programme is dedicated to delicate dishes such as glasses and china.</p> |
|  <p>Delicate: Delicate washing program is designed for delicate dishes which are not heavily soiled.</p> |  <p>Eco: Eco, this economic wash programme uses a low amount of water and energy in order to provide the most environmentally friendly cleaning option.</p> |

-  **Mix:** The Mix programme is suitable for mixed crockery and everyday pots and pans, without any particular incrustation.
-  **Express 27':** The Express 27' programme is a quick wash cycle, at low temperatures, for lightly soiled dishes.
-  **14 place settings:** Number of place settings.
-  **Touch controls:** Easy to use touch controls allow the appliance to be programmed at the touch of a button.
-  **Quick wash cycle:** Quick wash cycle for normally soiled mixed loads such as dishes and pans, even with dried-on residues. Dishes are washed and dried in 60 minutes.
-  **SILENT:** Wash cycle suitable for normally soiled dishes, even with dried-on residues. Ensures maximum noise reduction and is therefore ideal if you wish to run it during the night.
-  **Baking tray programme:** for intensive cleaning of the oven trays. Place the trays in the lower basket of the dishwasher.
-  **Soak programme:** The soak programme provides a rinse to prevent dirt from drying.
-  **Ultraclean:** The Ultraclean option performs a final rinse at a high temperature of 70°C eliminating virtually all bacteria.
-  **Total Acquastop:** In addition to the partial Acquastop protection present in all Smeg dishwashers, some models have an electronic device fitted to the water intake hose, which monitors water levels in the machine, detects leaks in the hose and switches off the water supply immediately when necessary.
-  **System WaterSave:** ensures the best washing results with minimal water consumption depending on the model of dishwasher.
-  **Dishwasher cleaning cycle:** The cycle should be started with the machine empty, without dishes. It is recommended to run the program every 2-3 months, using special dishwasher detergents.
-  Allows you to enable additional programs when selected together with any wash cycle.
-  **HYGIENE 99.9% High-temperature washing programme:** The 75° rinse guarantees the removal of 99.9% of germs and bacteria.