

# STU2FABCR2



<b>Product family</b>	Dishwashers
<b>Width</b>	24"
<b>Commercial height</b>	82 cm
<b>Installation</b>	Under counter built-in
<b>N° baskets</b>	3, FlexiDuo
<b>Engine</b>	Single phase
<b>EAN code</b>	8017709303624



## Programs



<b>Number of programs</b>	10	<b>Delicates</b>	Yes
<b>Washing temperatures</b>	38, 45, 50, 55, 65, 70, 75 °F	<b>Auto</b>	Yes
<b>Soak</b>	Yes	<b>Crystal &amp; China</b>	Yes
<b>Express 27'</b>	Yes	<b>Eco express</b>	Yes
<b>Mix</b>	Yes	<b>Express 60'</b>	Yes
<b>Sterilize</b>	Yes	<b>Pots &amp; Pans</b>	Yes

## Options



<b>Dry Assist option</b>	Yes	<b>Professional option</b>	
<b>Delay start</b>	Up to 9 hours	<b>Intensive washing zone option</b>	
<b>FlexiZone half-load option</b>	Yes	<b>Special programs option</b>	Yes

## Baskets



<b>Basket components finish</b>	Gray	<b>Largest loadable dish in upper basket</b>	23,5 inches
<b>Upper basket</b>	1 foldable rack	<b>Lower basket</b>	With 2 foldable racks
<b>Glass holder</b>	Yes	<b>Largest loadable dish in lower basket</b>	30,0 inches
<b>Upper basket height adjustment</b>	On 3 levels	<b>Cutlery basket</b>	Yes

Sliding Guides Extra Yes  
Glide

## Technical Features



Width	23 9/16 "
Depth	21 7/16 "
Display type	LED display (1 digit)
Height	32 3/16 "
Display	Delay start
Program symbols	Symbols
On/off indicator	Yes
Salt indicator	Light
Rinse aid indicator	Light
End-of-cycle indicator	Acoustic signal
Washing system	Planetarium
Third spray arm	Single
Water softener	With electronic setting
Turbidity sensor	Yes
Aquatest	

Flood protection system	Total Aquastop
Max water hardness	100°FH;58°dH
Drying system	Natural condenser drying, with Dry Assist automatic door opening system at the end of the cycle
Tub material	Stainless steel
Filter	Stainless steel
Concealed heating element	Yes
Hinges	Self-balancing with fixed hinges
Min. and max plinth height	3.9" - 6.6"
Adjustable feet	2 3/4", from 32 1/4" to 35"
Additional gaskets	Yes
Back cover	Yes
Depth of dishwasher with open door (mm)	1146
Top cover	Metal sheet

## Electrical Connection

Plug	(A) USA & Mexico	Frequency (Hz)	60 Hz
Connected power	1800 W	Connection type	Single-phase
Current	13 A	Power supply cable length	140 "
Voltage	115 V		

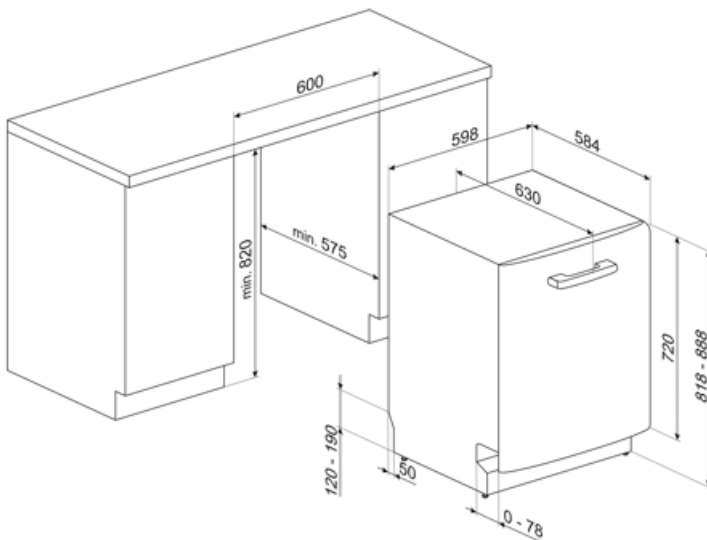

---

## Compatible Accessories

---

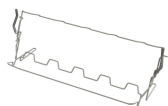

### KITGH

Kit glass holder. It has to be fitted on the first basket but only if there are foldable racks



### KITPL60FABN

Toekick Kit in Black colour with adjustable height. Can be fitted over all the fully integrated and underbench models with Fixed Fulcrum. Can be installed also on the models with variable fulcrum or flexifit hinges.



### KITPLV2

Kit extension for dishwasher and washing machine: lenght mt. 2



### KITPL60FABB



















Toekick Kit in White colour with adjustable height. Can be fitted over all the fully integrated and underbench models with Fixed Fulcrum. Can be installed also on the models with variable fulcrum or flexifit hinges.



### KITPL60FABX

Toekick Kit in Stainless Steel with adjustable height. Can be fitted over all the fully integrated and underbench models with Fixed Fulcrum. Can be installed also on the models with variable fulcrum or flexifit hinges.

## Symbols glossary

 <p>Aquatest measures the clarity of the water during an auto program, and automatically ensures the minimum consumption of water and energy.</p>	 <p>COMM_HEIGHT_82_72dpi</p>
 <p>Delay Timer: The delay timer can postpone the start of the program by up to 24 hours.</p>	 <p>Enersave: At the end of the drying cycle a special device slowly automatically opens the door a few centimeters, to ensure perfect drying and to save up to 20% of energy on some models.</p>
 <p>FlexiDuo: The FlexiDuo 3rd cutlery basket allows you to arrange cutlery or small cups, ladles, or bulky utensils however you like: it consists of two separate and moveable modules.</p>	 <p>FlexiZone: The ½ load flexizone allows you to wash a reduced load saving energy, water and time and there are no restrictions on where the items are placed.</p>
 <p>The new ExtraGlide guide system, available on top of the range models, makes the second basket even smoother and softer. In fact, it facilitates the extraction of the introduction, even at full load and, for the greater excursion, the insertion of crockery is also facilitated in the rear part.</p>	 <p>Noise Level: Excellent insulation and special devices keep noise to a minimum.</p>
 <p>PLANETARIUM_WASHING_SYSTEM_72dpi</p>	 <p>Delicate: Delicate washing program is designed for delicate dishes which are not heavily soiled.</p>
 <p>Delicate: Delicate washing program is designed for delicate dishes which are not heavily soiled.</p>	 <p>Normal programme: The normal programme is suitable for normal degrees of dirt for everyday use.</p>
 <p>Soak programme: The soak programme provides a rinse to prevent dirt from drying.</p>	 <p>Rapid 27 Mins: The rapid 27 mins quick program takes just 27 minutes to wash a load.</p>
 <p>The symbols show the number of plate settings of the dishwasher.</p>	 <p>Total Acquastop: In addition to the partial Acquastop protection present in all Smeg dishwashers, some models have an electronic device fitted to the water intake hose, which monitors water levels in the machine, detects leaks in the hose and switches off the water supply immediately when necessary.</p>
 <p>...</p>	 <p>...</p>

## Benefit (TT)

---

### FlexiDuo

The flexible third basket provides additional space, adapting to the load to accommodate various types of dishes, ensuring optimal organization and efficient use of interior capacity

The third FlexiDuo basket consists of two separate sections that can be handled independently of each other, stacked and/or removed, offering loading flexibility for every need. Depending on the arrangement, it allows cups, tall glasses, bulky utensils and pots and pans to be placed in the upper basket.

### Planetarium Wash System

Full and deep wash coverage thanks to the advanced movement of the spray arm, an innovation patented by Smeg

Smeg's patented Planetarium Wash System guarantees impeccable cleaning. With a simultaneous double movement of the sprayer and 65 rotations per minute, it reaches every nook and cranny for extraordinary results. Dishes, glasses and utensils will be perfectly clean in no time. An intelligent system where efficiency and style meet, delivering brilliant results effortlessly.

### Extra Glide Telescopic Guides

Smoother and more stable loading and unloading operations

Extra Glide telescopic guides ensure smooth and safe extraction of the upper basket, even with heavy loads. The telescopic design ensures smooth, stable and silent movement, improving ergonomics and convenience. Ideal for optimising space and ease of use, they combine durability and comfort in every washing operation.