

STU2FABRD2

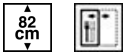

Product Family	Dishwashers
Commercial width	60 cm
Commercial height	82 cm
Installation	Under counter built-in
N° baskets	3, FlexiDuo
Motor	Single phase
EAN code	8017709303600



Programs



N. of programmes	10	Delicate	Yes
Washing temperatures	38, 45, 50, 55, 65, 70, 75 °F	Auto	Yes
Soak	Yes	Crystal & China	Yes
Express 27'	Yes	Eco express	Yes
Mix	Yes	Express 60'	Yes
Sterilise	Yes	Pots & Pans	Yes

Options



Dry Assist option	Yes	1/2 load FlexiZone option	Yes
Delay timer option	Up to 9 hours	Special programs option	Yes

Baskets



Basket components colour	Grey	Largest loadable dish in upper basket	23,5 inches
Upper Basket	With 1 foldable rack	Lower Basket	With 2 foldable racks
Glass holder	Yes	Largest loadable dish in lower basket	30,0 inches
Height adjustment of the upper basket	On three levels (5 cm)	Cutlery basket	Yes

Sliding Guides Extra Glide Yes

Technical Features



Width (mm)	23 9/16 "
Depth (mm)	21 7/16 "
Display type	LED display (1 digit)
Product Height (mm)	32 3/16 "
Display	Delayed start
Programme graphics	Symbols
On/off indicator	Yes
Salt light indicator	Light
Rinse aid indicator	Light
End of cycle indicator	Acoustic signal
Washing system	Planetarium
Third spray arm	Single
Water softener	With electronic setting
Turbidity sensor	Yes
Aquatest	

Flood protection system	Total Acquastop
Max water hardness	100°FH;58°dH
Drying system	Natural condenser drying, with Dry Assist automatic door opening system at the end of the cycle
Tub material	Stainless steel
Filter	Stainless steel
Concealed heating element	Yes
Hinges	Self balancing with fixed hinges
Min. and max plinth height	98 - 168 mm
Adjustable feet	7cm, from 820 to 890 mm
Additional gaskets	Yes
Back cover	Yes
Depth of dishwasher with open door (mm)	1146
Top cover	Metallic sheet

Electrical Connection

Plug	(A) USA e Messico	Frequency (Hz)	60 Hz
Connected power	1800 W	Type of connection	Single-phase
Current	13 A	Power supply cable length	140 "
Voltage	115 V		

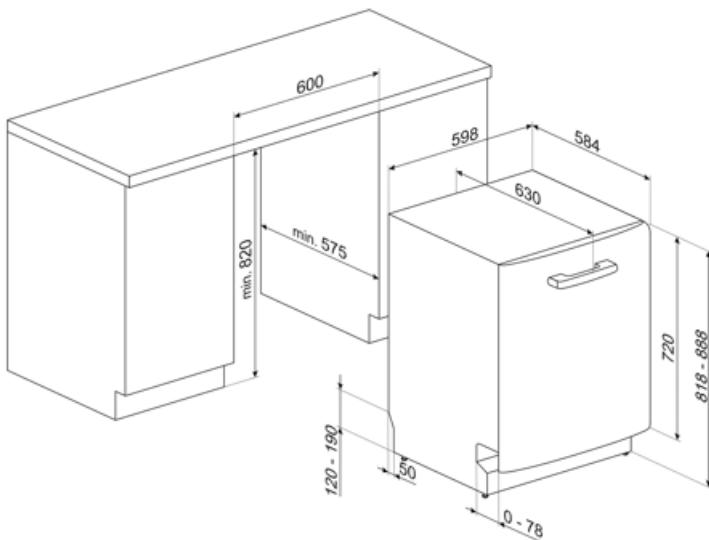

Not included accessories

KITGH

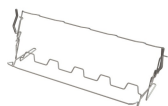

Kit glass holder. It has to be fitted on the first basket but only if there are foldable racks

KITPL60FABN



Toe kick Kit in Black colour with adjustable height. Can be fitted over all the fully integrated and underbench models with Fixed Fulcrum. Can be installed also on the models with variable fulcrum or flexifit hinges.

KITPLV2



Kit extension for dishwasher and washing machine: lenght mt. 2

KITPL60FABB





















Toe kick Kit in White colour with adjustable height. Can be fitted over all the fully integrated and underbench models with Fixed Fulcrum. Can be installed also on the models with variable fulcrum or flexifit hinges.

KITPL60FABX



Toe kick Kit in Stainless Steel with adjustable height. Can be fitted over all the fully integrated and underbench models with Fixed Fulcrum. Can be installed also on the models with variable fulcrum or flexifit hinges.

Symbols glossary (TT)

 <p>The Aquatest sensor is an electronic sensor that measures the degree of water transparency at the end of the initial soaking phase. Based on the values measured, the sensor sets the most suitable programme, thus obtaining the best washing results with the minimum amount of water.</p>	 <p>82 cm high</p>
 <p>Delay Timer: Option to postpone the start of the desired programme by up to 24 hours in order to programme the dishwasher to run at the desired time.</p>	 <p>The Dry Assist option ensures optimal drying of the dishes by automatically opening the door at the end of the wash cycle. Reducing the rinse temperature.</p>
 <p>FlexiDuo: The FlexiDuo 3rd cutlery basket allows you to arrange cutlery or small cups, ladles, or bulky utensils however you like: it consists of two separate and moveable modules.</p>	 <p>FlexiZone: The 1/2 load flexizone allows you to wash a reduced load saving energy, water and time and there are no restrictions on where the items are placed.</p>
 <p>The ExtraGlide guides system makes the second basket run even smoother and softer. It facilitates movement even when fully loaded, and thanks to the increased excursion, facilitates the insertion of dishes into the basket.</p>	 <p>Noise Level: Excellent insulation and special devices keep noise to a minimum.</p>
 <p>The Planetarium washing system, with high rotations per minute, guarantees complete coverage of the tank, thanks to the simultaneous rotation of base and sprayers, and excellent washing results.</p>	 <p>Delicate: Delicate washing program is designed for delicate dishes which are not heavily soiled.</p>
 <p>Delicate: Delicate washing program is designed for delicate dishes which are not heavily soiled.</p>	 <p>Mix: The Mix programme is suitable for mixed crockery and everyday pots and pans, without any particular incrustation.</p>
 <p>Soak programme: The soak programme provides a rinse to prevent dirt from drying.</p>	 <p>Express 27': The Express 27' programme is a quick wash cycle, at low temperatures, for lightly soiled dishes.</p>
 <p>13 place settings: Number of place settings.</p>	 <p>Total Acquastop: In addition to the partial Acquastop protection present in all Smeg dishwashers, some models have an electronic device fitted to the water intake hose, which monitors water levels in the machine, detects leaks in the hose and switches off the water supply immediately when necessary.</p>
 <p>Allows you to enable additional programs when selected together with any wash cycle. After having selected the required wash cycle, press the button (</p>	 <p>STERYL 75°: Intensive wash cycle ideal for plates, pots, pans, cutting boards, feeding bottles.</p>