

STU2FABRD2

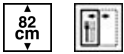

Product family	Dishwashers
Commercial height	82 cm
Installation	Under-Counter
N° baskets	3, FlexiDuo
Engine	Single phase
EAN code	8017709303600



Programs



Number of programs	10	Delicates	Yes
Washing temperatures	38, 45, 50, 55, 65, 70, 75 °F	Auto	Yes
Soak	Yes	Crystal & China	Yes
Express 27'	Yes	Eco express	Yes
Mix	Yes	Express 60'	Yes
Sterilize	Yes	Pots & Pans	Yes

Options



Dry Assist option	Yes	Professional option	
Delay start	Up to 9 hours	Intensive washing zone option	
FlexiZone half-load option	Yes	Special programs option	Yes

Baskets



Basket components finish	Gray	Largest loadable dish in upper basket	23,5 inches
Upper basket	1 foldable rack	Lower basket	With 2 foldable racks
Glass holder	Yes	Largest loadable dish in lower basket	30,0 inches
Upper basket height adjustment	On 3 levels	Cutlery basket	Yes

Sliding Guides Extra Glide Yes

Technical Features



Width	23 9/16 "
Depth	21 7/16 "
Display type	LED display (1 digit)
Height	32 3/16 "
Display	Delay start
Program symbols	Symbols
On/off indicator	Yes
Salt indicator	Light
Rinse aid indicator	Light
End-of-cycle indicator	Acoustic signal
Washing system	Planetarium
Third spray arm	Single
Water softener	With electronic setting
Turbidity sensor	Yes
Aquatest	

Flood protection system	Total Aquastop
Max water hardness	100°FH;58°dH
Drying system	Natural condenser drying, with Dry Assist automatic door opening system at the end of the cycle
Tub material	Stainless steel
Filter	Stainless steel
Concealed heating element	Yes
Hinges	Self-balancing with fixed hinges
Min. and max plinth height	3.9" - 6.6"
Adjustable feet	2 3/4", from 32 1/4" to 35"
Additional gaskets	Yes
Back cover	Yes
Depth of dishwasher with open door (mm)	1146 mm
Top cover	Metal sheet

Electrical Connection

Connected power	1800 W	Connection type	Single-phase
Current	13 A	Power supply cable length	140 "
Voltage	115 V	Plug	(A) USA & Mexico
Frequency (Hz)	60 Hz		



Compatible Accessories



KITGH

Kit glass holder. It has to be fitted on the first basket but only if there are foldable racks



KITPL60FABN

Toekick Kit in Black colour with adjustable height. Can be fitted over all the fully integrated and underbench models with Fixed Fulcrum. Can be installed also on the models with variable fulcrum or flexifit hinges.



KITPLV2

Kit extension for dishwasher and washing machine: lenght mt. 2



KITPL60FABB

Toekick Kit in White colour with adjustable height. Can be fitted over all the fully integrated and underbench models with Fixed Fulcrum. Can be installed also on the models with variable fulcrum or flexifit hinges.



KITPL60FABX

Toekick Kit in Stainless Steel with adjustable height. Can be fitted over all the fully integrated and underbench models with Fixed Fulcrum. Can be installed also on the models with variable fulcrum or flexifit hinges.

Alternative products



STU2FABCR2
Color: Cream





















STU2FABWH2
Color: White



STU2FABBL2
Color: Black

Symbols glossary

 <p>Aquatest measures the clarity of the water during an auto program, and automatically ensures the minimum consumption of water and energy.</p>	 <p>COMM_HEIGHT_82_72dpi</p>
 <p>Delay Timer: The delay timer can postpone the start of the program by up to 24 hours.</p>	 <p>Enersave: At the end of the drying cycle a special device slowly automatically opens the door a few centimeters, to ensure perfect drying and to save up to 20% of energy on some models.</p>
 <p>FlexiDuo: The FlexiDuo 3rd cutlery basket allows you to arrange cutlery or small cups, ladles, or bulky utensils however you like: it consists of two separate and moveable modules.</p>	 <p>FlexiZone: The ½ load flexizone allows you to wash a reduced load saving energy, water and time and there are no restrictions on where the items are placed.</p>
 <p>The new ExtraGlide guide system, available on top of the range models, makes the second basket even smoother and softer. In fact, it facilitates the extraction of the introduction, even at full load and, for the greater excursion, the insertion of crockery is also facilitated in the rear part.</p>	 <p>Noise Level: Excellent insulation and special devices keep noise to a minimum.</p>
 <p>PLANETARIUM_WASHING_SYSTEM_72dpi</p>	 <p>Delicate: Delicate washing program is designed for delicate dishes which are not heavily soiled.</p>
 <p>Delicate: Delicate washing program is designed for delicate dishes which are not heavily soiled.</p>	 <p>Normal programme: The normal programme is suitable for normal degrees of dirt for everyday use.</p>
 <p>Soak programme: The soak programme provides a rinse to prevent dirt from drying.</p>	 <p>Rapid 27 Mins: The rapid 27 mins quick program takes just 27 minutes to wash a load.</p>
 <p>The symbols show the number of plate settings of the dishwasher.</p>	 <p>Total Acquastop: In addition to the partial Acquastop protection present in all Smeg dishwashers, some models have an electronic device fitted to the water intake hose, which monitors water levels in the machine, detects leaks in the hose and switches off the water supply immediately when necessary.</p>
 <p>Allows you to enable additional programs when selected together with any wash cycle.</p>	 <p>STERYL 75°: Intensive wash cycle ideal for plates, pots, pans, cutting boards, feeding bottles.</p>