

STU8212



Product Family	Dishwashers
Commercial width	60 cm
Commercial height	82 cm
Installation	Fully-integrated built-in
N° baskets	2
EAN code	8017709303693



Programs



N. of programmes	5	Delicate	Yes
Washing temperatures	45, 50, 65, 70 °F	Normal	Yes
Mix	Yes	Pots & Pans	Yes
1/2 load	Yes		

Options



Delay timer option	3-6-9 hours	Intensive wash zone option	
Extra dry option	Yes		

Baskets

Basket colour	Grey	Lower Basket	With fixed racks
Upper Basket	With central fixed racks	Largest loadable dish in lower basket	35,0 inches
Height adjustment of the upper basket	On two levels, by extraction	Colour Inner Components	Blue
Largest loadable dish in upper basket	25,0 inches	Cutlery basket	13 place settings sliding

Technical Features



Width (mm)	23 9/16 "	Tub material	Stainless steel
Depth (mm)	21 7/16 "	Filter	Stainless steel
Product Height (mm)	32 3/16 "	Concealed heating element	Yes
Rinse aid indicator	Light	Hinges	Self balancing with fixed hinges
End of cycle indicator	Acoustic signal	Min. and max. frontal panel weight	2 - 9 lbs
Washing system	Standard	Min. and max plinth height	100 - 228 mm
Third spray arm	Single	Adjustable feet	7cm, from 820 to 890 mm
Flood protection system	Single Acquastop	Additional gaskets	Yes
Max water hardness	100°fH;58°dH	Back cover	Yes
Drying system	Natural condenser drying		

Electrical Connection

Connected power	1800 W	Type of connection	Single-phase
Current	13 A	Power supply cable length	140 "
Voltage	115 V	Plug	(A) USA e Messico
Frequency (Hz)	60 Hz		

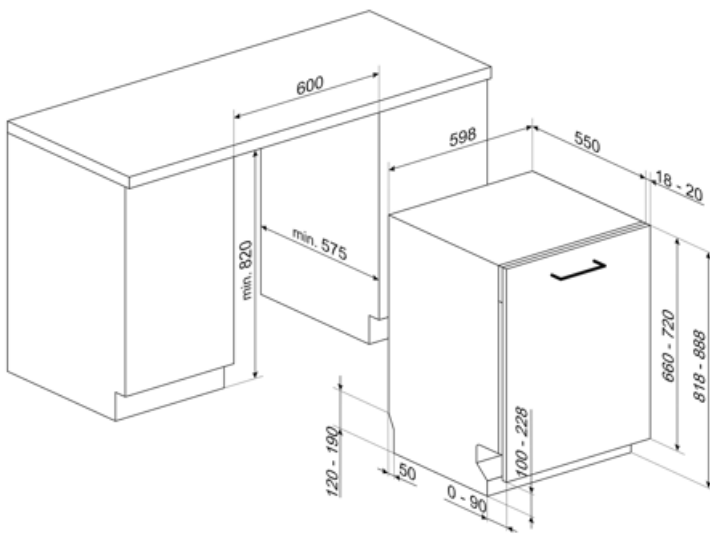

Compatible Accessories



KIT6CX

Classic aesthetics stainless steel panel with 14 mm. handle. Can be fitted on the fully integrated dishwashers.



KIT82CAN

Classic aesthetics anthracite panel with 14 mm. handle. Can be fitted on the fully integrated dishwashers.



KIT82CX



KITPL60FABB

Toekick Kit in White colour with adjustable height. Can be fitted over all the fully integrated and underbench models with Fixed Fulcrum. Can be installed also on the models with variable fulcrum or flexifit hinges.



KITPL60FABN

Toekick Kit in Black colour with adjustable height. Can be fitted over all the fully integrated and underbench models with Fixed Fulcrum. Can be installed also on the models with variable fulcrum or flexifit hinges.



KITPL60FABX











Toekick Kit in Stainless Steel with adjustable height. Can be fitted over all the fully integrated and underbench models with Fixed Fulcrum. Can be installed also on the models with variable fulcrum or flexifit hinges.



KITPLV2

Kit extension for dishwasher and washing machine: length mt. 2

Symbols glossary

	Acquastop: Some Smeg dishwashers are equipped with a simple Acquastop: float sensor in the bottom which is necessary to prevent an accidental leakage of water inside the appliance.		82 cm high
	Delay Timer: Option to postpone the start of the desired programme by up to 24 hours in order to programme the dishwasher to run at the desired time.		Noise Level: Excellent insulation and special devices keep noise to a minimum.
	1/2 load: This program is designed for washing dishes not heavily soiled with partial load of the dishwasher.		Delicate: Delicate washing program is designed for delicate dishes which are not heavily soiled.
	Mix: The Mix programme is suitable for mixed crockery and everyday pots and pans, without any particular incrustation.		13 place settings: Number of place settings.
	System WaterSave ensures the best washing results with minimal water consumption depending on the model of dishwasher.		EXTRA DRY This option adds a hot rinse cycle that ensures improved drying.