

STU8222



Product Family	Dishwashers
Commercial width	60 cm
Commercial height	82 cm
Installation	Fully-integrated built-in
N° baskets	2
EAN code	8017709303686



Programs



N. of programmes	10	1/2 load	Yes
Washing temperatures	38, 45, 50, 55, 65, 70, 75 °F	Delicate	Yes
Soak	Yes	Auto	Yes
Express 27'	Yes	Eco express	Yes
Mix	Yes	Express 60'	Yes
Sterilise	Yes	Pots & Pans	Yes

Options



Delay timer option	3-6-9 hours	Special programs option	Yes
Intensive wash zone option			

Baskets



Basket colour	Grey	Lower Basket	With 2 foldable racks
Upper Basket	With 1 foldable rack	Largest loadable dish in lower basket	35,0 inches
Height adjustment of the upper basket	On three levels (5 cm)	Colour Inner Components	Blue
Sliding Guides Extra Glide	Yes	Cutlery basket	13 place settings sliding
Largest loadable dish in upper basket	25,0 inches		

Technical Features



Width (mm)	23 9/16 "	Tube material	Stainless steel
Depth (mm)	21 7/16 "	Filter	Stainless steel
Product Height (mm)	32 3/16 "	Concealed heating element	Yes
Programme graphics	Symbols	Hinges	Self balancing with fixed hinges
Rinse aid indicator	Light	Min. and max. frontal panel weight	2 - 9 lbs
End of cycle indicator	Acoustic signal	Min. and max plinth height	100 - 228 mm
Washing system	Orbital	Adjustable feet	7cm, from 820 to 890 mm
Third spray arm	Single	Additional gaskets	Yes
Turbidity sensor Aquatest	Yes	Back cover	Yes
Flood protection system	Total Acquastop	Depth of dishwasher with open door (mm)	1186
Max water hardness	100°FH;58°dH	Top cover	Metallic sheet
Drying system	Natural condenser drying		

Performance / Energy Label - Reg. 2019



Airborne acoustical noise emissions 49 dB(A) re 1 pW

Electrical Connection

Plug	(A) USA e Messico	Frequency (Hz)	60 Hz
Connected power	1800 W	Type of connection	Single-phase
Current	13 A	Power supply cable length	140 "
Voltage	115 V		

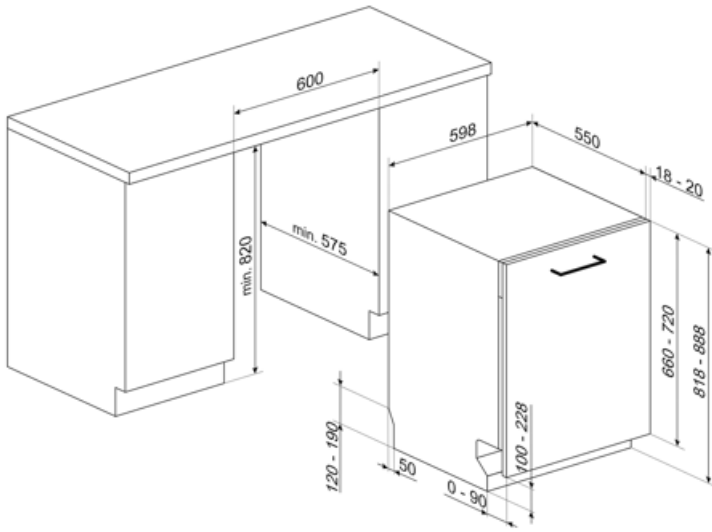

Compatible Accessories



KIT6CX

Classic aesthetics stainless steel panel with 14 mm. handle. Can be fitted on the fully integrated dishwashers.



KIT82CAN

Classic aesthetics anthracite panel with 14 mm. handle. Can be fitted on the fully integrated dishwashers.



KIT82CX

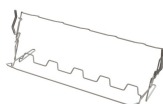

KITGH

Kit glass holder. It has to be fitted on the first basket but only if there are foldable racks



KITPL60FABB

Toe kick Kit in White colour with adjustable height. Can be fitted over all the fully integrated and underbench models with Fixed Fulcrum. Can be installed also on the models with variable fulcrum or flexifit hinges.



KITPL60FABN

Toe kick Kit in Black colour with adjustable height. Can be fitted over all the fully integrated and underbench models with Fixed Fulcrum. Can be installed also on the models with variable fulcrum or flexifit hinges.



KITPL60FABX

















Toe kick Kit in Stainless Steel with adjustable height. Can be fitted over all the fully integrated and underbench models with Fixed Fulcrum. Can be installed also on the models with variable fulcrum or flexifit hinges.



KITPLV2

Kit extension for dishwasher and washing machine: length mt. 2

Symbols glossary

 <p>The Aquatest sensor is an electronic sensor that measures the degree of water transparency at the end of the initial soaking phase. Used on the values measured, the sensor sets the most suitable programme, thus obtaining the best washing results with the minimum amount of water.</p>	 <p>82 cm high</p>
 <p>Delay Timer: Option to postpone the start of the desired programme by up to 24 hours in order to programme the dishwasher to run at the desired time.</p>	 <p>The ExtraGlide guides system makes the second basket run even smoother and softer. It facilitates movement even when fully loaded, and thanks to the increased excursion, facilitates the insertion of dishes into the basket.</p>
 <p>Noise Level: Excellent insulation and special devices keep noise to a minimum.</p>	 <p>Orbital wash system distributes water evenly throughout the 60cm dishwasher cavity, directing water with precision to ensure an excellent wash.</p>
 <p>Delicate: Delicate washing program is designed for delicate dishes which are not heavily soiled.</p>	 <p>1/2 load: This program is designed for washing dishes not heavily soiled with partial load of the dishwasher.</p>
 <p>Delicate: Delicate washing program is designed for delicate dishes which are not heavily soiled.</p>	 <p>Mix: The Mix programme is suitable for mixed crockery and everyday pots and pans, without any particular incrustation.</p>
 <p>Soak programme: The soak programme provides a rinse to prevent dirt from drying.</p>	 <p>Express 27': The Express 27' programme is a quick wash cycle, at low temperatures, for lightly soiled dishes.</p>
 <p>13 place settings: Number of place settings.</p>	 <p>Total Acquastop: In addition to the partial Acquastop protection present in all Smeg dishwashers, some models have an electronic device fitted to the water intake hose, which monitors water levels in the machine, detects leaks in the hose and switches off the water supply immediately when necessary.</p>
 <p>System WaterSave ensures the best washing results with minimal water consumption depending on the model of dishwasher.</p>	 <p>Allows you to enable additional programs when selected together with any wash cycle. After having selected the required wash cycle, press the button (</p>
 <p>STERYL 75°: Intensive wash cycle ideal for plates, pots, pans, cutting boards, feeding bottles.</p>	

Benefit (TT)

Orbital Wash System

Even water distribution, deep cleaning and low noise thanks to the dual rotating spray arms

Orbital washing system, which, thanks to its double arm, its 7 water exit points and thanks to overlapping and simultaneous rotations and 40 rotations per minute, allows ample coverage of the tank area, thus guaranteeing optimal results in any basket-loading configuration.

Extra Glide Telescopic Guides

Smoother and more stable loading and unloading operations

Extra Glide telescopic guides ensure smooth and safe extraction of the upper basket, even with heavy loads. The telescopic design ensures smooth, stable and silent movement, improving ergonomics and convenience. Ideal for optimising space and ease of use, they combine durability and comfort in every washing operation.