

STU8623



Product Family	Dishwashers
Commercial width	60 cm
Commercial height	86 cm
Installation	Fully-integrated built-in
N° baskets	3, FlexiDuo
EAN code	8017709303648



Programs



N. of programmes	10	Delicate	Yes
Washing temperatures	38, 45, 50, 55, 65, 70, 75 °F	Normal	Yes
Soak	Yes	Crystal & China	Yes
Express 27'	Yes	Eco express	Yes
Mix	Yes	Express 60'	Yes
Sterilise	Yes	Pots & Pans	Yes

Options



Dry Assist option	Yes	1/2 load FlexiZone option	Yes
Delay timer option	Up to 9 hours	Special programs option	Yes

Baskets



Basket colour	Grey	Lower Basket	With 2 foldable racks
Upper Basket	With 1 foldable rack	Largest loadable dish in lower basket	35,0 inches
Height adjustment of the upper basket	On three levels (5 cm)	Colour Inner Components	Blue
Sliding Guides Extra Glide	Yes	Cutlery basket	Yes
Largest loadable dish in upper basket	18,0 inches		

Technical Features



Width (mm)	23 9/16 "	Max water hardness	100°FH;58°dH
Depth (mm)	21 5/8 "	Drying system	Natural condenser drying, with Dry Assist automatic door opening system at the end of the cycle
Display type	LED display (3 digit)	Tub material	Stainless steel
Product Height (mm)	33 3/4 "	Filter	Stainless steel
Display	Delayed start, Programme time indicator, Time to end indication	Concealed heating element	Yes
Programme graphics	Symbols	Hinges	Self balancing with variable hinges
Salt light indicator	Light	Min. and max. frontal panel weight	2 - 9 lbs
Rinse aid indicator	Light	Min. and max plinth height	100 - 228 mm
End of cycle indicator	Led on display, with acoustic signal	Adjustable feet	7cm, from 860 to 930 mm
Washing system	Orbital	Additional gaskets	Yes
Third spray arm	Single	Back cover	Yes
Water softener	With electronic setting	Depth of dishwasher with open door (mm)	1186 mm
Flood protection system	Single Acquastop	Top cover	Metallic sheet

Electrical Connection

Connected power	1800 W	Type of connection	Single-phase
Current	13 A	Power supply cable length	140 "
Voltage	115 V	Plug	(A) USA e Messico
Frequency (Hz)	60 Hz		

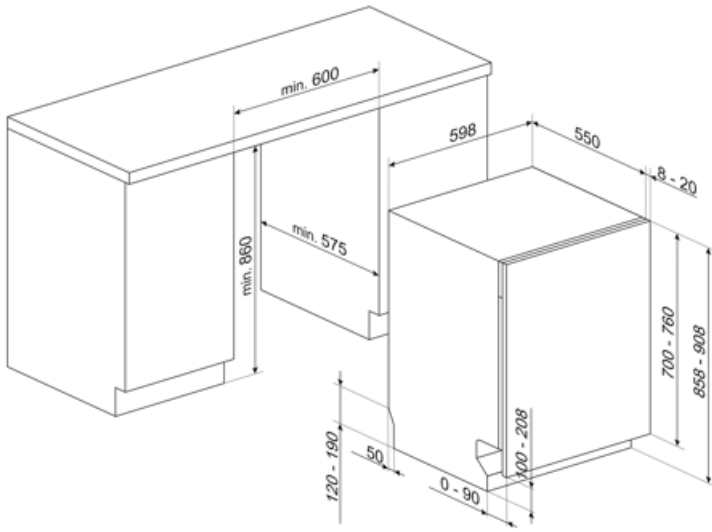

Compatible Accessories



KIT86CX-1

Door kit, stainless steel, Canali handle, fully integrated dishwasher h.86 cm
Compatible with models with Flexifit and fixed fulcrum hinges.



KIT86VX

stainless steel panel with Victoria handle. Can be fitted on the fully integrated dishwashers H86 with no Flexifit hinges. It is not possible to install it on the models with stainless steel panel

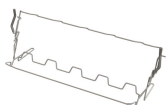

KITGH

Kit glass holder. It has to be fitted on the first basket but only if there are foldable racks



KITPL60B

Toekick Kit in White colour with adjustable height and deepness. Can be installed over all the fully integrated and underbench models with variable fulcrum or flexifit hinges.



KITPL60N

Toekick Kit in Black colour with adjustable height and deepness. Can be installed over all the fully integrated and underbench models with variable fulcrum or flexifit hinges.

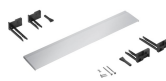

KITPL60X

















Toekick Kit in Stainless Steel with adjustable height and deepness. Can be fitted over all the fully integrated and underbench models with variable fulcrum or flexifit hinges.



KITPLV2

Kit extension for dishwasher and washing machine: length mt. 2

Symbols glossary

 <p>Acquastop: Some Smeg dishwashers are equipped with a simple Acquastop: float sensor in the bottom which is necessary to prevent an accidental leakage of water inside the appliance.</p>	 <p>86 cm high</p>
 <p>Delay Timer: Option to postpone the start of the desired programme by up to 24 hours in order to programme the dishwasher to run at the desired time.</p>	 <p>The Dry Assist option ensures optimal drying of the dishes by automatically opening the door at the end of the wash cycle. Reducing the rinse temperature</p>
 <p>FlexiDuo: The FlexiDuo 3rd cutlery basket allows you to arrange cutlery or small cups, ladles, or bulky utensils however you like: it consists of two separate and moveable modules.</p>	 <p>FlexiZone: The ½ load flexizone allows you to wash a reduced load saving energy, water and time and there are no restrictions on where the items are placed.</p>
 <p>The ExtraGlide guides system makes the second basket run even smoother and softer. It facilitates movement even when fully loaded, and thanks to the increased excursion, facilitates the insertion of dishes into the basket.</p>	 <p>Noise Level: Excellent insulation and special devices keep noise to a minimum.</p>
 <p>Orbital wash system distributes water evenly throughout the 60cm dishwasher cavity, directing water with precision to ensure an excellent wash.</p>	 <p>Delicate: Delicate washing program is designed for delicate dishes which are not heavily soiled.</p>
 <p>Mix: The Mix programme is suitable for mixed crockery and everyday pots and pans, without any particular incrustation.</p>	 <p>Soak programme: The soak programme provides a rinse to prevent dirt from drying.</p>
 <p>Express 27': The Express 27' programme is a quick wash cycle, at low temperatures, for lightly soiled dishes.</p>	 <p>13 place settings: Number of place settings.</p>
 <p>System WaterSave ensures the best washing results with minimal water consumption depending on the model of dishwasher.</p>	 <p>Allows you to enable additional programs when selected together with any wash cycle.</p>
 <p>STERYL 75°: Intensive wash cycle ideal for plates, pots, pans, cutting boards, feeding bottles.</p>	