

STU8623



Product family	Dishwashers
Width	24"
Commercial height	86 cm
Installation	Fully-Integrated
N° baskets	3, FlexiDuo
EAN code	8017709303648



Programs



Number of programs	10	Delicates	Yes
Washing temperatures	38, 45, 50, 55, 65, 70, 75 °F	Normal	Yes
Soak	Yes	Crystal & China	Yes
Express	Yes	Eco express	Yes
Mix	Yes	Express 60'	Yes
Sterilize	Yes	Pots & Pans	Yes

Options



Dry Assist option	Yes	FlexiZone half-load option	Yes
Delay start	Up to 9 hours	Special programs option	Yes

Baskets



Basket color	Gray	Lower basket	With 2 foldable racks
Upper basket	1 foldable rack	Largest loadable dish in lower basket	35,0 inches
Upper basket height adjustment	On 3 levels	Colour Inner Components	Blue
Sliding Guides Extra Glide	Yes	Cutlery basket	Yes
Largest loadable dish in upper basket	18,0 inches		

Technical Features



Width	23 9/16 "	Drying system	Dry Assist
Depth	21 5/8 "	Tube material	Stainless steel
Display type	LED display (3 digits)	Filter	Stainless steel
Height	33 3/4 "	Concealed heating element	Yes
Display	Delay start, Program progress indicator, Time-to-end indicator	Hinges	Self-balancing with variable hinges
Program symbols	Symbols	Min. and max. frontal panel weight	4.4 - 19.8 lbs
Salt indicator	Light	Min. and max plinth height	4" - 9"
Rinse aid indicator	Light	Adjustable feet	2 3/4", from 33 7/8" to 36 5/8"
End-of-cycle indicator	Light on display, with acoustic signal	Additional gaskets	Yes
Washing system	Orbital	Back cover	Yes
Third spray arm	Single	Depth of dishwasher with open door (mm)	1186 mm
Water softener	With electronic setting	Top cover	Metal sheet
Flood protection system	Single Aquastop	Energy Star	Yes
Max water hardness	100°FH;58°dH		

Electrical Connection

Connected power	1800 W	Connection type	Single-phase
Current	13 A	Power Cord Length	140 "
Voltage	115 V	Plug	(A) USA & Mexico
Frequency	60 Hz		

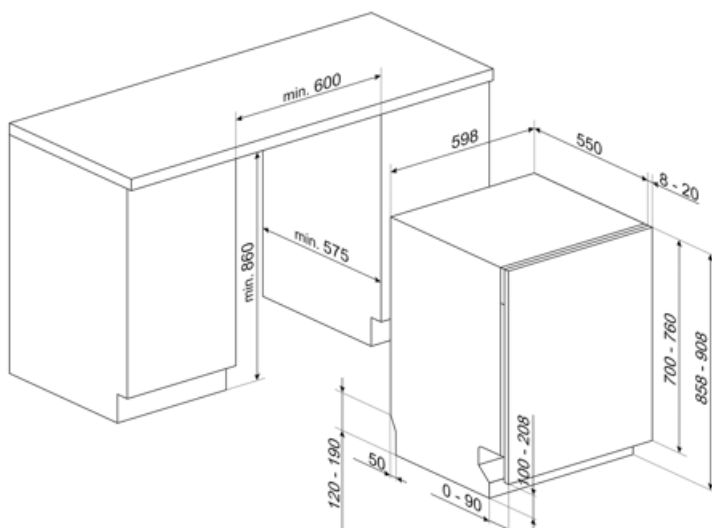

Compatible Accessories



KIT86CX-1

Door kit, stainless steel, Canali handle, fully integrated dishwasher h.86 cm
Compatible with models with Flexifit and fixed fulcrum hinges.



KIT86VX

stainless steel panel with Victoria handle. Can be fitted on the fully integrated dishwashers H86 with no Flexifit hinges. It is not possible to install it on the models with stainless steel panel

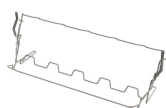

KITGH

Kit glass holder. It has to be fitted on the first basket but only if there are foldable racks



KITPL60B

Toekick Kit in White colour with adjustable height and deepness. Can be installed over all the fully integrated and underbench models with variable fulcrum or flexifit hinges.



KITPL60N

Toekick Kit in Black colour with adjustable height and deepness. Can be installed over all the fully integrated and underbench models with variable fulcrum or flexifit hinges.



KITPL60X

















Toekick Kit in Stainless Steel with adjustable height and deepness. Can be fitted over all the fully integrated and underbench models with variable fulcrum or flexifit hinges.



KITPLV2

Kit extension for dishwasher and washing machine: length mt. 2

Symbols glossary

 <p>Acquastop: Some Smeg dishwashers are equipped with a simple Acquastop: float sensor in the bottom which is necessary to prevent an accidental leakage of water inside the appliance.</p>	 <p>COMM_HEIGHT_86_72dpi</p>
 <p>Delay Timer: The delay timer can postpone the start of the program by up to 24 hours.</p>	 <p>Enersave: At the end of the drying cycle a special device slowly automatically opens the door a few centimeters, to ensure perfect drying and to save up to 20% of energy on some models.</p>
 <p>FlexiDuo: The FlexiDuo 3rd cutlery basket allows you to arrange cutlery or small cups, ladles, or bulky utensils however you like: it consists of two separate and moveable modules.</p>	 <p>FlexiZone: The ½ load flexizone allows you to wash a reduced load saving energy, water and time and there are no restrictions on where the items are placed.</p>
 <p>The new ExtraGlide guide system, available on top of the range models, makes the second basket even smoother and softer. In fact, it facilitates the extraction of the introduction, even at full load and, for the greater excursion, the insertion of crockery is also facilitated in the rear part.</p>	 <p>Noise Level: Excellent insulation and special devices keep noise to a minimum.</p>
 <p>Orbital wash system distributes water evenly throughout the 60cm dishwasher cavity, directing water with precision to ensure an excellent wash.</p>	 <p>Delicate: Delicate washing program is designed for delicate dishes which are not heavily soiled.</p>
 <p>Normal programme: The normal programme is suitable for normal degrees of dirt for everyday use.</p>	 <p>Soak programme: The soak programme provides a rinse to prevent dirt from drying.</p>
 <p>Rapid 27 Mins: The rapid 27 mins quick program takes just 27 minutes to wash a load.</p>	 <p>The symbols show the number of plate settings of the dishwasher.</p>
 <p>System WaterSave ensures the best washing results with minimal water consumption depending on the model of dishwasher.</p>	 <p>Allows you to enable additional programs when selected together with any wash cycle.</p>
 <p>STERYL 75°: Intensive wash cycle ideal for plates, pots, pans, cutting boards, feeding bottles.</p>	