

STU8633



Product family	Dishwashers
Width	24"
Commercial height	86 cm
Installation	Fully-Integrated
N° baskets	3, FlexiDuo
EAN code	8017709303655



Programs



Number of programs	10+1	Daily (half load)	Yes
Washing temperatures	38, 45, 50, 55, 65, 70, 75 °F	Delicates	Yes
Soak	Yes	Auto	Yes
Express	Yes	Crystal & China	Yes
Mix	Yes	Eco express	Yes
Self Clean	Yes	Pots & Pans	Yes
Sterilize	Yes		

Options



Dry Assist option	Yes	Intensive washing zone option	
Delay start	Up to 24 hours	Special programs option	Yes

Baskets



Basket color	Gray	Lower basket	With 4 foldable racks
Upper basket	3 foldable racks	Largest loadable dish in lower basket	35,0 inches
Upper basket height adjustment	On 3 levels	Colour Inner Components	Blue
Sliding Guides Extra Glide	Yes	Cutlery basket	Yes

Largest loadable dish in 18,0 inches upper basket

Technical Features



Width	23 9/16 "	Drying system	Dry Assist
Depth	21 5/8 "	Internal lighting	White LED
Display type	LED display (3 digits)	Tube material	Stainless steel
Height	33 3/4 "	Filter	Stainless steel
Display	Delay start, Program progress indicator, Time-to-end indicator	Concealed heating element	Yes
Program symbols	Symbols	Hinges	Self-balancing, Sliding, FLEXIFIT
Salt indicator	Light	Min. and max. frontal panel weight	4.4 - 22 lbs
Rinse aid indicator	Light	Min. and max plinth height	50 - 215 mm
End-of-cycle indicator	ActiveLight	Adjustable feet	2 3/4", from 33 7/8" to 36 5/8"
Washing system	Planetarium	Additional gaskets	Yes
Third spray arm	Single	Back cover	Yes
Water softener	With electronic setting	Depth of dishwasher with open door (mm)	1186 mm
Turbidity sensor Aquatest	Yes	Top cover	Metal sheet
Flood protection system	Total Aquastop	Energy Star	Yes
Max water hardness	100°FH;58°dH		

Electrical Connection

Connected power	1800 W	Connection type	Single-phase
Current	13 A	Power Cord Length	140 "
Voltage	115 V	Plug	(A) USA & Mexico
Frequency	60 Hz		

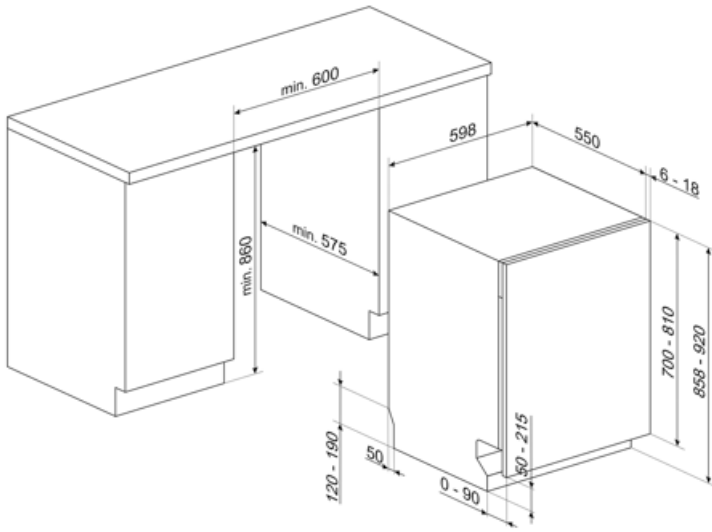

Compatible Accessories



KIT86CX-1

Door kit, stainless steel, Canali handle, fully integrated dishwasher h.86 cm
Compatible with models with Flexifit and fixed fulcrum hinges.



KITFLEXI

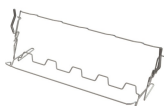

KITGH

Kit glass holder. It has to be fitted on the first basket but only if there are foldable racks



KITPL60B

Toe kick Kit in White colour with adjustable height and deepness. Can be installed over all the fully integrated and underbench models with variable fulcrum or flexifit hinges.



KITPL60N

Toe kick Kit in Black colour with adjustable height and deepness. Can be installed over all the fully integrated and underbench models with variable fulcrum or flexifit hinges.



KITPL60X























Toe kick Kit in Stainless Steel with adjustable height and deepness. Can be fitted over all the fully integrated and underbench models with variable fulcrum or flexifit hinges.



KITPLV2

Kit extension for dishwasher and washing machine: lenght mt. 2

Symbols glossary

	<p>Activelight is an led light which projects a red spot onto the floor beneath the dishwasher when the appliance is in use.</p>		<p>Aquatest measures the clarity of the water during an auto program, and automatically ensures the minimum consumption of water and energy.</p>
	<p>COMM_HEIGHT_86_72dpi</p>		<p>Delay Timer: The delay timer can postpone the start of the program by up to 24 hours.</p>
	<p>Enersave: At the end of the drying cycle a special device slowly automatically opens the door a few centimeters, to ensure perfect drying and to save up to 20% of energy on some models.</p>		<p>FlexiDuo: The FlexiDuo 3rd cutlery basket allows you to arrange cutlery or small cups, ladles, or bulky utensils however you like: it consists of two separate and moveable modules.</p>
	<p>Models with new Flexi Fit hinges are able to be installed in kitchens with a plinth of just 5cms. With this new hinge design, the panel has a sliding movement from the bottom to the top, avoiding any possible interference of the panel with the plinth.</p>		<p>The new ExtraGlide guide system, available on top of the range models, makes the second basket even smoother and softer. In fact, it facilitates the extraction of the introduction, even at full load and, for the greater excursion, the insertion of crockery is also facilitated in the rear part.</p>
	<p>Noise Level: Excellent insulation and special devices keep noise to a minimum.</p>		<p>PLANETARIUM_WASHING_SYSTEM_72dpi</p>
	<p>Delicate: Delicate washing program is designed for delicate dishes which are not heavily soiled.</p>		<p>1/2 load: This program is designed for washing dishes not heavily soiled with partial load of the dishwasher.</p>
	<p>Delicate: Delicate washing program is designed for delicate dishes which are not heavily soiled.</p>		<p>Normal programme: The normal programme is suitable for normal degrees of dirt for everyday use.</p>
	<p>Soak programme: The soak programme provides a rinse to prevent dirt from drying.</p>		<p>Rapid 27 Mins: The rapid 27 mins quick program takes just 27 minutes to wash a load.</p>
	<p>The symbols show the number of plate settings of the dishwasher.</p>		<p>Total Acquastop: In addition to the partial Acquastop protection present in all Smeg dishwashers, some models have an electronic device fitted to the water intake hose, which monitors water levels in the machine, detects leaks in the hose and switches off the water supply immediately when necessary.</p>
	<p>System WaterSave ensures the best washing results with minimal water consumption depending on the model of dishwasher.</p>		<p>Dishwasher cleaning cycle. The cycle should be started with the machine empty, without dishes. It is recommended to run the program every 2-3 months, using special dishwasher detergents.</p>
	<p>Allows you to enable additional programs when selected together with any wash cycle.</p>		<p>STERYL 75°: Intensive wash cycle ideal for plates, pots, pans, cutting boards, feeding bottles.</p>