

STX32BLLC



Familie	Vaatwasser
Commerciële breedte	60 cm
Nishoogte	82 cm
Installatie	Onderbouw
Aantal korven	3, FlexiDuo met Easy Glide
EAN-code	8017709307394



Programma's / functies



Aantal programma's	10+1	Auto sensor 45-65	Ja
Wastemperatuur	38, 45, 50, 55, 65, 70, 75 °C	Mix	Ja
Weken	Ja	Stil (-2dB)	Ja
Snel 27'	Ja	Intensief	Ja
Krystal	Ja	Zelf reinigen	Ja
Snel - Volledig 60'	Ja	Hygiëne 99,9%	Ja
Eco	Ja		

Opties



Dry Assist + opties	Ja	FlexiZone ½ (halve beladingsmogelijkheid)	Ja
Delay timer optie	Tot 24 uur, i.c.m. automatisch spoelen	Optie speciale programma's	Ja

Korven



Kleur korven	Grijs	Sliding Guides Extra Glide	Ja
Kleur korfcomponenten	Grijs	Maximum afmetingen bord dat in bovenste korf kan worden geladen	19,0 cm
Handgreep	Op onder- en bovenkorf		
Bovenkorf	Met 3 opvouwbaar rekken		
Glazen houder	Ja		

In hoogte verstelbare bovenkorf	3 niveaus	Onderkorf	Met 4 opvouwbare rekken
		Onderkorf met anti-drup inserts	Ja
		Maximum afmetingen bord dat in onderste korf kan worden geladen	30,0 cm
		Kleur binnenonderdelen	Blauw

Technische specificaties



Breedte product	598 mm	Watertoevoer	Enkel; koud en warm water tot 60°C - energiebesparing tot 35%
Diepte product	545 mm	Maximale waterhardheid	100°FH;58°dH
Type display	3 cijfers	Droogstelsysteem	Natuurlijk condensor drogen met Dry Assist + automatische deuropeningssysteem aan het einde van de cyclus
Hoogte product	818 mm	Stoombeveiliging	Van plaatstaal
Bediening	Elektronisch	Binnenverlichting	With White led
Display	Instelling Delay timer, Programma duur indicator, Resttijd indicatie	Materiaal kuip	RVS
Grafische weergave programma's	Symbolen	Filter	RVS
Aan/uit indicator	Ja	Verborgen verwarmingselement	Ja
Zout indicator	Indicator (lampje)	Scharnieren	Zelfbalancerend met variabel steunpunt
Glansspoelmiddel indicator	Indicator (lampje)	Min. en max plinthoogte	100 - 228 mm
Indicator einde cyclus	ActiveLight	Verstelbare voetjes	7 cm, van 820 tot 890 mm
Wassysteem	Planetarium	Extra pakkingen	Ja, met roestvrijstalen plaat
Derde sproeiarm	Enkel	Back cover	Ja
Waterontkalker	Elektronisch instelbaar	Diepte vaatwasser met open deur (mm)	1146
Aquatest sensor	Ja	Voetjes achterzijde vanaf de voorkant regelbaar	Ja
Overstroombeveiliging	Total Acquastop	Bovenbedekking	Van kunststof

Performance / Energy Label - Reg. 2019

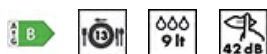

Energie-efficiëntieklasse (wascyclus)	B	Programmaduur	4:25 h:min
Energy consumption [per 100 cycles, based on the eco programme]	63 KWh	Geluidsniveau	42 dB(A) re 1 pW
Nominale capaciteit (ps)	13	Akoestisch geluidsemisatieklasse	B
Water verbruik (per cyclus)	9,0 litres	Energy efficiency Index (EEI)	37,9

Elektrische aansluiting

Stekker	(F;E) Schuko	Frequentie	50 Hz
Aansluitwaarde	1800 W	Type aansluiting	Single-phase
Stroom	10 A	Lengte voedingskabel	140 cm
Spanning	220-240 V		

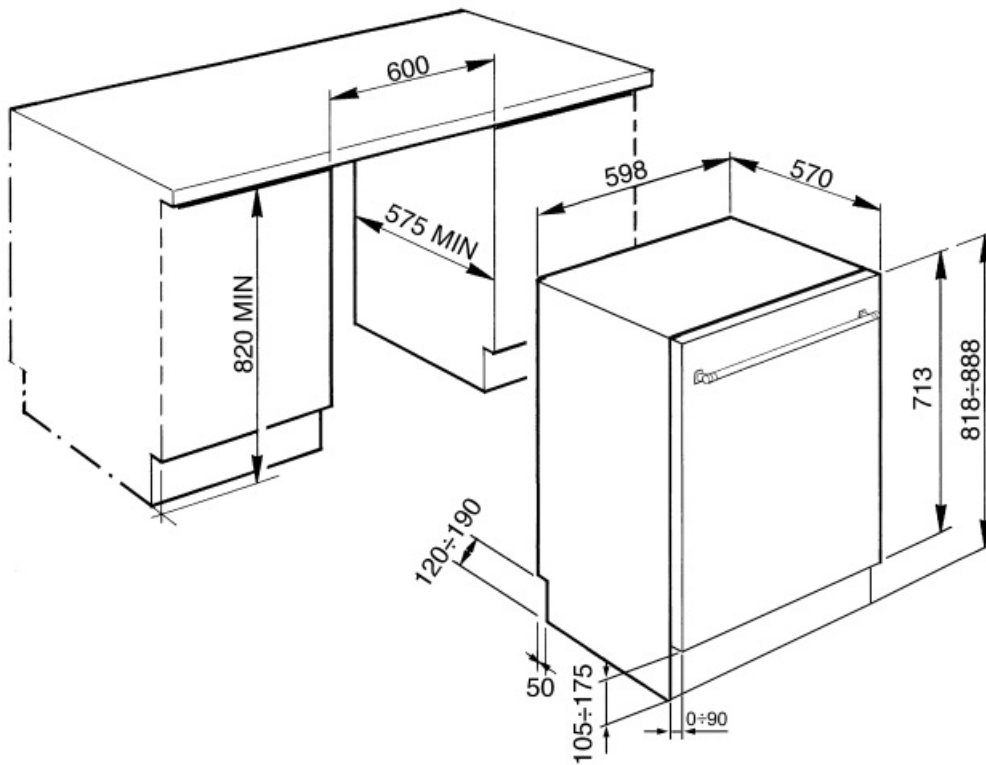

Accessoires niet inbegrepen



KITPL60N

Toekick Kit in zwarte kleur met verstelbare hoogte en diepte. Kan worden geïnstalleerd over alle volledig geïntegreerde modellen en onderbouw modellen met variabel draaipunt of flexifit-scharnieren.



KITPL60X

Toekick Kit in roestvrij staal met verstelbare hoogte en diepte. Kan worden gemonteerd over alle volledig geïntegreerde modellen en onderbouw modellen met variabel draaipunt of flexifit-scharnieren.



KITPL60B

Toekick Kit in witte kleur met verstelbare hoogte en diepte. Kan worden geïnstalleerd over alle volledig geïntegreerde modellen en modellen onderbouw met variabel draaipunt of flexifit-scharnieren.



KITPLV2



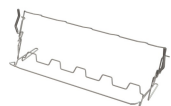





















Kit verlengstuk voor vaatwasser en wasmachine: lengte 2 mtr.



KITGH

Kit glazen houder. Deze moet op de eerste mand worden gemonteerd, maar alleen als er inklapbare rekken zijn

Symbols glossary (TT)

	<p>Activelight is een led die een rode stip projecteert op de vloer onder de vaatwasser als het apparaat in gebruik is</p>		<p>Aquatest meet de helderheid van het water tijdens een automatisch programma en zorgt automatisch voor een minimaal verbruik van water en energie</p>
	<p>To improve the drying of dishes without leaving stains.</p>		<p>82 cm high</p>
	<p>Vertragingstimer: De uitgestelde timer kan de start van het programma tot 24 uur uitstellen.</p>		<p>Energy efficiency class B</p>
	<p>The Dry Assist + option, in addition to saving energy, ensures perfect drying of the dishes by opening the door automatically at the end of the washing cycle.</p>		<p>FlexiDuo: The FlexiDuo 3rd cutlery basket allows you to arrange cutlery or small cups, ladles, or bulky utensils however you like: it consists of two separate and moveable modules.</p>
	<p>FlexiZone: The ½ load flexizone allows you to wash a reduced load saving energy, water and time and there are no restrictions on where the items are placed.</p>		<p>The ExtraGlide guides system makes the second basket run even smoother and softer. It facilitates movement even when fully loaded, and thanks to the increased excursion, facilitates the insertion of dishes into the basket.</p>
	<p>Noise Level: Excellent insulation and special devices keep noise to a minimum.</p>		<p>The Planetarium washing system, with high rotations per minute, guarantees complete coverage of the tank, thanks to the simultaneous rotation of base and sprayers, and excellent washing results.</p>
	<p>Auto 45°- 65°: The auto programme regulates the length of a cycle depending on the need for a pre-wash and the number of rinses required.</p>		<p>Crystals: The Crystals programme is dedicated to delicate dishes such as glasses and china.</p>
	<p>Eco: Eco, this economic wash programme uses a low amount of water and energy in order to provide the most environmentally friendly cleaning option.</p>		<p>Quick wash cycle for normally soiled mixed loads such as dishes and pans, even with dried-on residues. Dishes are washed and dried in 60 minutes.</p>
	<p>Mix: The Mix programme is suitable for mixed crockery and everyday pots and pans, without any particular incrustation.</p>		<p>Dishwasher cleaning cycle. The cycle should be started with the machine empty, without dishes. It is recommended to run the program every 2-3 months, using special dishwasher detergents.</p>
	<p>SILENT: Wash cycle suitable for normally soiled dishes, even with dried-on residues. Ensures maximum noise reduction and is therefore ideal if you wish to run it during the night.</p>		<p>Allows you to enable additional programs when selected together with any wash cycle. After having selected the required wash cycle, press the button (</p>
	<p>Soak programme: The soak programme provides a rinse to prevent dirt from drying.</p>		<p>Express 27': The Express 27' programme is a quick wash cycle, at low temperatures, for lightly soiled dishes.</p>
	<p>Ultraclean: The Ultraclean option performs a final rinse at a high temperature of 70°C eliminating virtually all bacteria.</p>		<p>13 place settings: Number of place settings.</p>



Total Acquastop: In addition to the partial Acquastop protection present in all Smeg dishwashers, some models have an electronic device fitted to the water intake hose, which monitors water levels in the machine, detects leaks in the hose and switches off the water supply immediately when necessary.



HYGIENE 99.9% High-temperature washing programme. The 75° rinse guarantees the removal of 99.9% of germs and bacteria.



System WaterSave ensures the best washing results with minimal water consumption depending on the model of dishwasher.