

SX91SV9

| | |
|--|-------------------|
| Cooker size | 90x60 cm |
| N.º de cavidades com rótulo energético | 1 |
| Fonte de calor da cavidade | ELECTRICITY |
| Hob type | Gas |
| Tipo de forno principal | Thermo-ventilated |
| Sistema de limpeza no forno principal | No |
| EAN code | 8017709246686 |
| Energy efficiency class | A |



Aesthetics



| | | | |
|-----------------------------|------------------------------------|--------------------------------|-------------------------|
| Aesthetic | Classica | Type of control setting | Control knobs |
| Serie | Concerto | Control knobs | Smeg Classic |
| Design | Standard | Controls colour | Stainless steel |
| Colour | Stainless steel | No. of controls | 8 |
| Acabamento | Satin | Cor da serigrafia | Serigrafia em preto |
| Command panel finish | Stainless steel | Door | Full glass |
| Logo | Logotipo embutido | Glass type | Stopsol |
| Posição do logotipo | Logotipo no painel abaixo do forno | Handle | Smeg Classic |
| Lid | Grey glass with two strips | Handle Colour | Brushed stainless steel |
| Cor da placa | Stainless steel | Storage compartment | No |
| Type of pan stands | Matt black enamelled flat | Feet | Silver |

Programs / Functions

No. of cooking functions 6

Traditional cooking functions



Static



Fan assisted



Turbo



Eco



Large grill



Fan assisted bottom

Other functions



Defrost by time

Recipes No
 Cleaning functions

 Vapor clean

Hob technical features

UR

Total no. of cook zones 5

Front left - Gas - Rapid - 2.90 kW

Rear left - Gas - Semi Rapid - 1.80 kW

Central - Gas - UR - 4.00 kW

Rear right - Gas - Semi Rapid - 1.80 kW

Front right - Gas - AUX - 1.00 kW

Type of gas burners Standard

Gas safety valves Yes

Automatic electronic ignition Yes

Burner caps Matt black enamelled

Main Oven Technical Features



No. of lights 1
Fan number 1
Net volume of the cavity 115 l
Gross volume, 1st cavity 129 l
Cavity material Ever Clean enamel
No. of shelves 5
Type of shelves Metal racks
Roof Liner No
Light type Halogen
Light Power 40 W
Cooking time setting Conta-minutos + cozimento fino
Light when oven door is open No
Door opening Flap down
Removable door Yes
Full glass inner door Yes

Removable inner door Yes
Total no. of door glasses 2
No. of thermo-reflective door glasses 1
Safety Thermostat Yes
Cooling system Tangential
Usable cavity space dimensions (HxWxD) 371x724x418 mm
Temperature control Electro-mechanical
Lower heating element power 1700 W
Upper heating element - Power 1200 W
Grill element 1700 W
Large grill - Power 2900 W
Circular heating element - Power 2000 W
Grill type Electric
Tilting grill No
Soft Close system No

Options Main Oven

Timer No
End of cooking acoustic alarm Yes

Minimum Temperature 50 °C
Maximum temperature 260 °C

Accessories included for Main Oven & Hob

| | | | |
|-------------------------------------|---|----------------|---|
| Moka stand | 1 | 40mm deep tray | 1 |
| Rack com batente traseiro e lateral | 1 | Grill mesh | 1 |

Electrical Connection

| | | | |
|------------------------------|-----------|------------------------------------|-------------------------|
| Plug | No | Electric cable | Installed, Single phase |
| Electrical connection rating | 3200 W | Comprimento do cabo de alimentação | 120 cm |
| Current | 14 A | Frequency | 50/60 Hz |
| Voltage | 220-240 V | Bloco de terminais | 3 polos |

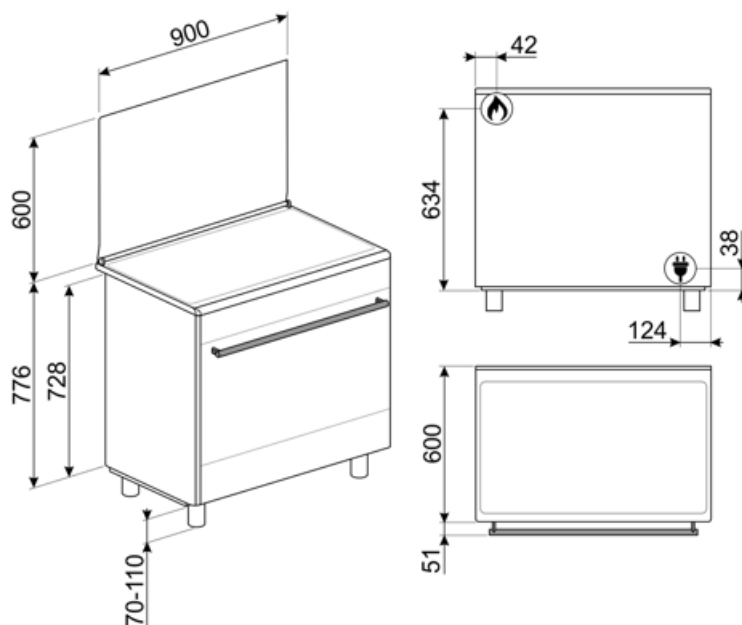

Compatible Accessories

AIRFRY9

Air fryer rack AIRFRY . Ideal for recreating traditional frying in the oven, but with fewer calories and less fat. It allows you to cook quickly and simply dishes such as French fries, fried vegetables and fish, ensuring perfect browning and crispiness.



BBQ9



BN920

GTP

** Guias telescópicas parcialmente extraíveis (1 nível)** Extração: 300 mm
Material: Aço inoxidável AISI 430 polido



KIT600SNL-9

Faixa de cobertura para placa traseira, adequado para fogões Concerto 90 centímetros



KITH95

Kit extensão de altura (950 mm), aço inoxidável



PALPZ

Pá para pizza com alça dobrável
largura: 315mm comprimento : 325mm



SFLK1

Bloqueio para crianças



AL90X9

Suporte adequado para fogões Concerto de 90 cm SX91



BG6090-1

Placa grelhadora de ferro fundido adequada para fogões Concerto



BN940

GTT

** Guias telescópicas totalmente extraíveis (1 nível)** Extração: 433 mm
Material: Aço inoxidável AISI 430 polido



KIT90X9-1

Painel anti-salpicos, 90x60 cm, aço inoxidável, para fogões Concerto



KITPDQ

Pés de redução de altura (850 mm), de aço inoxidável, para fogões



PPR9

Pedra para pizza refratária sem pegas. Pedra em forma quadrada: L64xH2,3xP37,5 cm Adequada também para fornos a gás, para ser colocada na grelha.







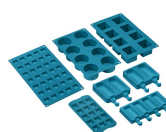













SMOLD

Conjunto de 7 moldes de silicone para sorvetes, gelados, pralinés, cubos de gelo ou para porção de alimentos. Utilizável de -60°C a +230°C



Symbols glossary

| | |
|---|---|
|  <p>R: Desempenho de secagem do produto, medido de A++ a D/G, dependendo da família de produtos</p> |  <p>Instalação em coluna: Instalação em coluna</p> |
|  <p>Sistema de arrefecimento a ar: para garantir temperaturas de superfície seguras.</p> |  <p>Descongela pelo tempo: com esta função, o tempo de descongelamento dos alimentos é determinado automaticamente.</p> |
|  <p>Portas de vidros duplos: Número de portas envidraçadas.</p> |  <p>Interior esmaltado: O interior em esmalte de todos os fornos Smeg tem um revestimento antiácido especial que ajuda a manter o interior limpo, reduzindo a quantidade de gordura de cozimento aderente a ele.</p> |
|  <p>Circogas: Em fornos a gás, o ventilador distribui o calor de forma rápida e uniforme por toda a cavidade do forno, evitando a transferência de sabor ao cozinhar vários pratos diferentes ao mesmo tempo. Em fornos elétricos, esta combinação completa o cozimento mais rapidamente de alimentos que estão prontos na superfície, mas que exigem mais cozimento no interior, sem mais escurecimento.</p> |  <p>Ventilador com elementos superiores e inferiores: Os elementos combinados com o ventilador visam fornecer calor mais uniforme, um método semelhante ao cozimento convencional, de modo que o pré-aquecimento é necessário. Mais adequado para itens que exigem métodos de cozimento lento.</p> |
|  <p>Somente elementos superior e inferior: um método de cozimento tradicional mais adequado para itens individuais localizados no centro do forno. A parte superior do forno será sempre mais quente. Ideal para assados, bolos de frutas, pão, etc.</p> |  <p>ECO: A combinação da grelha, ventilador e elemento inferior é particularmente adequada para cozinhar pequenas quantidades de alimentos.</p> |
|  <p>Elemento de grelha O uso de grelha dá excelentes resultados ao cozinhar carne de porções médias e pequenas, especialmente quando combinada com uma rotisseria (sempre que possível). Também é ideal para cozinhar salsichas e bacon.</p> |  <p>Circulaire com elementos superior e inferior: O uso do ventilador com ambos os elementos permite que os alimentos sejam cozinhados de forma rápida e eficaz, ideal para grandes peças que exigem cozimento completo. Oferece um resultado semelhante ao da rotisseria, movendo o calor em torno do alimento, em vez de mover o próprio alimento, permitindo que qualquer tamanho ou forma seja cozida.</p> |
|  <p>Toda a porta interna de vidro: Toda a porta interna de vidro, uma única superfície plana que é simples de manter limpa.</p> |  <p>O vidro interior da porta: pode ser removido com alguns movimentos rápidos para limpeza.</p> |
|  <p>Luzes laterais: Duas luzes laterais opostas aumentam a visibilidade dentro do forno.</p> |  <p>Abertura automática: alguns modelos têm porta de abertura automática quando o ciclo é terminado, o que é uma solução perfeita para unidades de cozinha sem alça, pois nenhuma alça é necessária. Por razões de segurança, a porta trava automaticamente quando a máquina está em uso para evitar que seja aberta inadvertidamente.</p> |
|  <p>O compartimento do forno tem 5 níveis de cozimento diferentes.</p> |  <p>Queimadores ultrarrápidos: Queimadores ultrarrápidos potentes oferecem até 5kw de potência.</p> |



Limpeza a Vapor: uma função de limpeza simples que utiliza vapor para afrouxar os depósitos no compartimento do forno.



A capacidade indica a quantidade de espaço útil no compartimento do forno em litros.



Controle dos botões

Benefit (TT)

Gas hob

Gas provides permanent control of the heat source and the temperature change is immediate
Equipped with a thermocouple, the gas supply is cut off if the flame is extinguished for greater safety.

Ever Clean Enamel

Easy oven cleaning thanks to special pyrolytic enamel

True-convection

The best cooking performances guaranteed by ventilated circular flow
Multiple fans and heating elements guarantee the perfect aerodynamic heat flow, allowing homogeneous and quicker cooking inside the cavity.

Multilevel cooking

Several cooking levels allow maximum flexibility of use

Multilevel halogen light

Internal halogen lighting on different levels guarantees excellent visibility

Removable inner glass

Internal door glasses are easily removable for complete cleaning

Tangential cooling

New cooling system with tangential fan and airflow from the door to the splashback

Isothermic Cavity

The best cooking performance at the highest energy efficiency

BBQ (optional accessory)

Barbeque cooking directly in the oven with the double-sided grill (BBQ optional accessory)

Pizza stone (optional accessory)

Baking with refractory stone for soft and crispy pizza and yeast products (STONE optional accessory)

Cold door

During any function, the external door glass is cold, avoiding any risk of burns

AirFry (AIRFRY optional accessory)

Lighter and tastier food thanks to airfry basket (optional accessory)

Adjustable height

Cooker top flushed with the working area thanks to adjustable feet

Single turbine

The oven has a fan equipped with a circular heating element allowing cooking with rotating heat