

# SY93I-1

Cooker size	90x60 cm
N.º de cavidades com rótulo energético	2
Fonte de calor da cavidade	ELECTRICITY
Hob type	Induction
Tipo de forno principal	Thermo-ventilated
Type of second oven	Thermo-ventilated
Sistema de limpeza no forno principal	Vapor Clean
EAN code	8017709308742
Energy efficiency class	A
Energy efficiency class, second cavity	B



## Aesthetics



<b>Aesthetic</b>	Classica	<b>Control knobs</b>	Smeg Classic
<b>Serie</b>	Sinfonia	<b>Controls colour</b>	Stainless steel
<b>Design</b>	Square design	<b>No. of controls</b>	9
<b>Colour</b>	Stainless steel	<b>Cor da serigrafia</b>	Serigrafia em preto
<b>Acabamento</b>	Satin	<b>Display</b>	Touch
<b>Command panel finish</b>	Stainless steel	<b>Door</b>	With 2 horizontal strips
<b>Logo</b>	Logotipo serigrafado	<b>Glass type</b>	eclipse
<b>Posição do logotipo</b>	Logotipo no painel de comandos	<b>Handle</b>	Smeg Classic
<b>Upstand</b>	Yes	<b>Handle Colour</b>	Brushed stainless steel
<b>Cor da placa</b>	Esmalte preto	<b>Plinth</b>	Black

## Programs / Functions

No. of cooking functions 5

Traditional cooking functions



Static



Fan assisted



Circulaire



Eco



Fan assisted bottom

### Other functions



Defrost by time

## Cleaning functions





## Programs / Functions Auxiliary Oven

Funções de cozedura cavidade 2 1  
 Funções tradicionais de cozimento, cavidade 2



Defrost No  
 Vapor Clean No

## Programs / Functions Third Oven

No. of functions third oven 1  
 Oven light   
 Half grill No  
 Full grill 

## Hob technical features



Total no. of cook zones 5

Front left - Induction - single - 2.30 kW - Booster 3.00 kW - - Ø 21.0 cm

Rear left - Induction - single - 1.40 kW - - Ø 18.0 cm

Central - Induction - single - 2,3 kW - Booster 3 kW - - Ø 27.0 cm

Rear right - Induction - single - 1,4 kW - Booster 3.00 kW - - Ø 18.0 cm

Front right - Induction - single - 2.30 kW - Booster 3.00 kW - - Ø 21.0 cm

Automatic switch off when overheat Yes Selected zone indicator Yes

Automatic pan detection Yes Residual heat indicator Yes

Minimum pan diameter indication Yes

## Main Oven Technical Features



No. of lights	1	Removable inner door	Yes
Fan number	1	Total no. of door glasses	3
Net volume of the cavity	61 l	No. of thermo-reflective door glasses	1
Gross volume, 1st cavity	70 l	Safety Thermostat	Yes
Cavity material	Ever Clean enamel	Cooling system	Tangential
No. of shelves	4		

Type of shelves	Metal racks	Usable cavity space dimensions (HxWxD)	316x460x412 mm
Roof Liner	No	Temperature control	Electro-mechanical
Light type	Halogen	Lower heating element power	1200 W
Light Power	40 W	Upper heating element - Power	1000 W
Cooking time setting	Start and Stop	Grill element	1700 W
Door opening	Side opening	Large grill - Power	2700 W
Removable door	Yes	Circular heating element - Power	2000 W
Full glass inner door	Yes	Grill type	Electric
		Tilting grill	Yes

## Options Main Oven

Timer	Yes	Minimum Temperature	50 °C
End of cooking acoustic alarm	Yes	Maximum temperature	260 °C

## Second Oven Technical Features



Fan number	1	Full glass inner door	Yes
Net volume of the second cavity	62 l	Removable inner door	Yes
Gross volume, 2nd cavity	69 l	No. total door glasses	2
Cavity material	Ever Clean enamel	No. thermo-reflective door glasses	1
No. of shelves	9	Safety Thermostat	Yes
Type of shelves	Metal racks	Cooling system	Tangential
Roof Liner	No	Usable cavity space dimensions (HxWxD)	605x275x370 mm
No. of lights	1	Temperature control	Electro-mechanical
Light type	Halogen	Potência da resistência circular	2500 W
Light Power	40 W	Grill type	Electric
Door opening	Side opening	Tilting grill	No
Removable door	Yes		

## Options Auxiliary Oven

Timer	No	Minimum Temperature	50 °C
End of cooking acoustic alarm	No	Maximum temperature	245 °C

## Third Oven Technical Features



Net volume, 3rd cavity	36 l	Full glass inner door	Yes
------------------------	------	-----------------------	-----

Gross volume, 3rd cavity	41 l	Removable inner door	Yes
Cavity material	Ever Clean enamel	No. total door glasses	3
No. of shelves	2	No. of thermo-reflective door glasses	1
Type of shelves	Metal racks	Safety Thermostat	Yes
Roof Liner	No	Cooling system	Tangential
No. of lights	1	Usable cavity space dimensions (HxWxD)	169x440x443 mm
Light type	Halogen	Temperature control	Electro-mechanical
Light Power	40 W	Large grill - Power	2700 W
Door opening	Flap down	Grill type	Electric
Removable door	Yes	Tilting grill	Yes

## Options Third Oven

Timer	No	Minimum Temperature	50 °C
End of cooking acoustic alarm	No	Maximum temperature	260 °C

## Accessories included for Main Oven & Hob



Rack com batente traseiro e lateral 40mm deep tray	2	Grill mesh	1
	1	Telescopic Guide rails, partial Extraction	1

## Accessories included for Secondary Oven



Oven grid with back stop	4	Plate rack/warmer	1
--------------------------	---	-------------------	---

## Accessories included for Third Oven

Rack com batente traseiro e lateral	1	40mm deep tray	1
-------------------------------------	---	----------------	---

## Electrical Connection

Plug	No	Comprimento do cabo de alimentação	150 cm
Electrical connection rating	15000 W	Type of electric cable	Double and Three Phase
Current	42 A	Frequency	50 Hz
Voltage	220-240 V	Bloco de terminais	5 polos
Electric cable	Installed, Single phase		

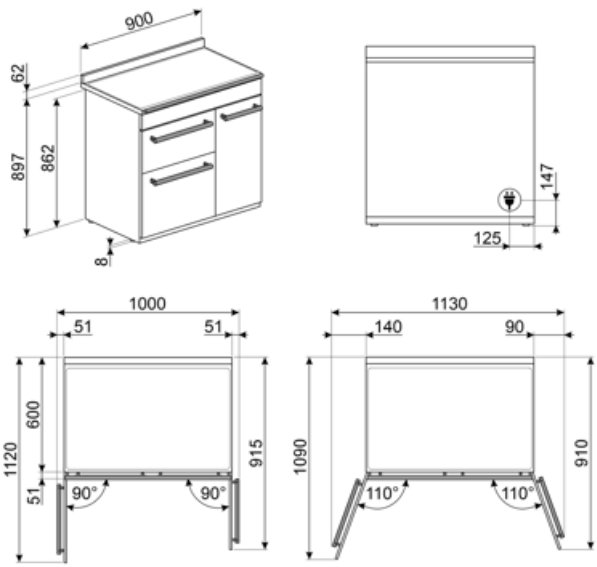

## Compatible Accessories

### AIRFRY

Air fryer rack AIRFRY . Ideal for recreating traditional frying in the oven, but with fewer calories and less fat. It allows you to cook quickly and simply dishes such as French fries, fried vegetables and fish, ensuring perfect browning and crispiness.



### BN620-1

Tabuleiro esmaltado, 20mm de profundidade



### BNP608T

Bandeja revestida de teflon, 8mm de profundidade, a ser colocada na grade



### GTP

\*\* Guias telescópicas parcialmente extraíveis (1 nível)\*\* Extração: 300 mm  
Material: Aço inoxidável AISI 430 polido



### KITC9X9-1

Painel anti-salpicos, 90x75 cm, aço inoxidável, adequado para fogões Portofino, Master e Sinfonia



### PALPZ

Pá para pizza com alça dobrável  
largura: 315mm comprimento : 325mm



### SFLK1

Bloqueio para crianças



### TPKPLATE

Placa universal para placas de indução, gás, cerâmica e fogões elétricos. Superfície antiaderente ideal para cozinhar peixe, ovos e vegetais. Dimensões: 410 X 240 mm.



### BBQ

Double sided plate BBQ. Suitable for recreating succulent and crispy dishes in the oven with the typical taste of grilled cooking. The ribbed side is particularly suitable for meats and cheeses. The smooth side for fish, seafood and vegetables.



### BN640

Tabuleiro esmaltado, 40mm de profundidade

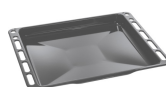

### GRILLPLATE

Placa de rede universal para indução, gás, cerâmica e fogões elétricos. Superfície antiaderente ideal para cozinhar carne, queijo e vegetais. Dimensões: 410 x 240 mm.



### GTT

\*\* Guias telescópicas totalmente extraíveis (1 nível)\*\* Extração: 433 mm  
Material: Aço inoxidável AISI 430 polido



### KITPBX

Pés de redução de altura (850 mm)



### SCRP

Placas de indução e de cerâmica e raspador teppanyaki







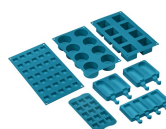





























### SMOLD

Conjunto de 7 moldes de silicone para sorvetes, gelados, pralinés, cubos de gelo ou para porção de alimentos. Utilizável de -60°C a +230°C



## Symbols glossary

 <p>R: Desempenho de secagem do produto, medido de A++ a D/G, dependendo da família de produtos</p>	 <p>B: Classificação de energia do produto, medida de A+++ a D/G, dependendo da família de produtos.</p>
 <p>Instalação em coluna: Instalação em coluna</p>	 <p>Sistema de arrefecimento a ar: para garantir temperaturas de superfície seguras.</p>
 <p>Descongela pelo tempo: com esta função, o tempo de descongelamento dos alimentos é determinado automaticamente.</p>	 <p>Portas de vidros duplos: Número de portas envidraçadas.</p>
 <p>Portas envidraçadas triplas: Número de portas envidraçadas.</p>	 <p>ECO-logic: opção permite-lhe restringir o limite de potência da poupança de energia real do aparelho.</p>
 <p>Interior esmaltado: O interior em esmalte de todos os fornos Smeg tem um revestimento antiácido especial que ajuda a manter o interior limpo, reduzindo a quantidade de gordura de cozimento aderente a ele.</p>	 <p>Circogas: Em fornos a gás, o ventilador distribui o calor de forma rápida e uniforme por toda a cavidade do forno, evitando a transferência de sabor ao cozinhar vários pratos diferentes ao mesmo tempo. Em fornos elétricos, esta combinação completa o cozimento mais rapidamente de alimentos que estão prontos na superfície, mas que exigem mais cozimento no interior, sem mais escurecimento.</p>
 <p>Ventilador com elementos superiores e inferiores: Os elementos combinados com o ventilador visam fornecer calor mais uniforme, um método semelhante ao cozimento convencional, de modo que o pré-aquecimento é necessário. Mais adequado para itens que exigem métodos de cozimento lento.</p>	 <p>Somente elementos superior e inferior: um método de cozimento tradicional mais adequado para itens individuais localizados no centro do forno. A parte superior do forno será sempre mais quente. Ideal para assados, bolos de frutas, pão, etc.</p>
 <p>Circularaire: A combinação do ventilador e do elemento circular em torno dele dá um método de cozimento de ar quente. Isso oferece muitos benefícios, incluindo nenhum pré-aquecimento se o tempo de cozimento for superior a 20 minutos, nenhuma transferência de sabor ao cozinhar alimentos diferentes ao mesmo tempo, menos energia e tempos de cozimento mais curtos. Bom para todos os tipos de alimentos.</p>	 <p>ECO: A combinação da grelha, ventilador e elemento inferior é particularmente adequada para cozinhar pequenas quantidades de alimentos.</p>
 <p>Elemento de grelha O uso de grelha dá excelentes resultados ao cozinhar carne de porções médias e pequenas, especialmente quando combinada com uma rotisseria (sempre que possível). Também é ideal para cozinhar salsichas e bacon.</p>	 <p>Luz</p>
 <p>Protecção contra o sobreaquecimento: O sistema de segurança que desliga automaticamente a placa em caso de sobreaquecimento da unidade de controle.</p>	 <p>Indução: O trabalho destas placas baseia-se no princípio da indução electromagnética. O calor é gerado diretamente na parte inferior da panela durante o seu contato com a placa.</p>

-  Toda a porta interna de vidro: Toda a porta interna de vidro, uma única superfície plana que é simples de manter limpa.
-  Luzes laterais: Duas luzes laterais opostas aumentam a visibilidade dentro do forno.
-  Indicação de calor residual: Depois de a placa de cerâmica de vidro ter sido desligada, o indicador de calor residual mostra qual das zonas de aquecimento ainda permanece quente. Quando a temperatura cai abaixo de 60°C, o indicador se apaga.
-  O compartimento do forno tem 4 níveis de cozimento diferentes.
-  Trilhos telescópicos: permitem puxar o prato e verificá-lo sem ter que removê-lo completamente do forno.
-  Grelha basculante: a grelha basculante pode ser facilmente desengatada para mover o elemento de aquecimento e limpar o tejadilho do aparelho em um simples passo.
-  A capacidade indica a quantidade de espaço útil no compartimento do forno em litros.
-  A capacidade indica a quantidade de espaço útil no compartimento do forno em litros.
-  O vidro interior da porta: pode ser removido com alguns movimentos rápidos para limpeza.
-  Aquecimento: Uma opção para aquecer o prato e manter as refeições preparadas quentes.
-  O compartimento do forno tem 2 níveis de cozimento diferentes.
-  O compartimento do forno tem 9 níveis de cozimento diferentes.
-  Comando eletrônico. Permite manter a temperatura no interior do forno com a precisão de 2-3 ° C. Isso permite cozinhar refeições que são muito sensíveis a mudanças de temperatura, como por ex. bolos, suflês, pudins.
-  Limpeza a Vapor: uma função de limpeza simples que utiliza vapor para afrouxar os depósitos no compartimento do forno.
-  A capacidade indica a quantidade de espaço útil no compartimento do forno em litros.
-  ...



## Benefit (TT)

---

### **Induction hob**

Induction offers fast cooking and precise temperature control

Through the use of suitable cookware, induction is easy to use and maintain, safe and responsive.

### **Vapor Clean**

By inserting water into a recess at the bottom of the cavity, steam is generated, which softens the residue and facilitates its removal

By inserting water into a recess at the bottom of the cavity, steam is generated, which softens the residue and facilitates its removal.

### **Touch control**

Easy and intuitive timer setting with a single touch

### **True-convection**

The best cooking performances guaranteed by ventilated circular flow

Multiple fans and heating elements guarantee the perfect aerodynamic heat flow, allowing homogeneous and quicker cooking inside the cavity.

### **Multilevel cooking**

Several cooking levels allow maximum flexibility of use

### **Multilevel halogen light**

Internal halogen lighting on different levels guarantees excellent visibility

### **Removable inner glass**

Internal door glasses are easily removable for complete cleaning

### **Tangential cooling**

New cooling system with tangential fan and airflow from the door to the splashback

### **Telescopic guides**

Easy extraction and safe insertion of trays into the oven thanks to telescopic guides

### **Isothermic Cavity**

The best cooking performance at the highest energy efficiency

### **BBQ (optional accessory)**

Barbeque cooking directly in the oven with the double-sided grill (BBQ optional accessory)

**Pizza stone (optional accessory)**

Baking with refractory stone for soft and crispy pizza and yeast products (STONE optional accessory)

**Cold door**

During any function, the external door glass is cold, avoiding any risk of burns

**AirFry (AIRFRY optional accessory)**

Lighter and tastier food thanks to airfry basket (optional accessory)

**Adjustable height**

Cooker top flushed with the working area thanks to adjustable feet

**Single turbine**

The oven has a fan equipped with a circular heating element allowing cooking with rotating heat