

# TR103IGR

Cooker size	100x60 cm
N.º de cavidades com rótulo energético	2
Fonte de calor da cavidade	ELECTRICITY
Hob type	Induction
Tipo de forno principal	Thermo-ventilated
Type of second oven	Thermo-ventilated
Sistema de limpeza no forno principal	Vapor Clean
EAN code	8017709294236
Energy efficiency class	A
Energy efficiency class, second cavity	B



## Aesthetics



<b>Aesthetic</b>	Victoria	<b>Controls colour</b>	Stainless steel
<b>Design</b>	Victoria	<b>No. of controls</b>	10
<b>Colour</b>	Cinza ardósia	<b>Cor da serigrafia</b>	Serigrafia em prateado
<b>Command panel finish</b>	Enamelled metal	<b>Display</b>	electronic 5 buttons
<b>Logo</b>	Logotipo Anni 50	<b>Door</b>	With frame
<b>Posição do logotipo</b>	Logotipo na zona da placa+ Logotipo no painel de comandos	<b>Glass type</b>	Black
<b>Upstand</b>	Yes	<b>Handle</b>	Smeg Victoria
<b>Cor da placa</b>	Esmalte preto	<b>Handle Colour</b>	Brushed stainless steel
<b>Type of pan stands</b>	Cast Iron	<b>Plinth</b>	Anthracite
<b>Control knobs</b>	Smeg Victoria		

## Programs / Functions

No. of cooking functions 8

Traditional cooking functions



Static



Circulaire



Turbo



Eco



Small grill



Large grill



Fan grill (large)



Fan assisted bottom

Recipes

No

## Cleaning functions

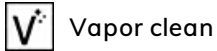

## Programs / Functions Auxiliary Oven

Funções de cozedura cavidade 2 1  
 Funções tradicionais de cozimento, cavidade 2



Defrost No  
 Vapor Clean No

## Programs / Functions Third Oven

No. of functions third oven 1  
 Oven light   
 Half grill No  
 Full grill 

## Hob technical features

Total no. of cook zones 5

Front left - Induction - single - 1.30 kW - Booster 1.40 kW - Ø 18.0 cm  
 Rear left - Induction - single - 2.30 kW - Booster 3.00 kW - Ø 21.0 cm  
 Central - Induction - single - 2.30 kW - Booster 3.00 kW - Ø 27.0 cm  
 Rear right - Induction - single - 1.30 kW - Booster 1.40 kW - Ø 18.0 cm  
 Front right - Induction - single - 2.30 kW - Booster 3.00 kW - Ø 21.0 cm

## Main Oven Technical Features



No. of lights	1	Removable inner door	No
Fan number	1	Total no. of door glasses	3
Net volume of the cavity	61 l	No. of thermo-reflective door glasses	1
Gross volume, 1st cavity	70 l	Safety Thermostat	Yes
Cavity material	Ever Clean enamel	Cooling system	Tangential
No. of shelves	4	Usable cavity space dimensions (HxWxD)	316x460x412 mm
Type of shelves	Metal racks	Temperature control	Electro-mechanical
Roof Liner	No	Lower heating element power	1200 W
Light type	Halogen	Upper heating element - Power	1000 W
Light Power	40 W	Grill element	1700 W
Cooking time setting	Start and Stop		
Door opening	Side opening		
Removable door	Yes		

Full glass inner door Yes

Large grill - Power 2700 W  
 Circular heating element - Power 2000 W  
 Grill type Electric  
 Tilting grill Yes

## Options Main Oven

Timer Yes  
 End of cooking acoustic alarm Yes

Minimum Temperature 50 °C  
 Maximum temperature 260 °C

## Second Oven Technical Features



Net volume of the second cavity 84 l  
 Gross volume, 2nd cavity 94 l  
 Cavity material Ever Clean enamel  
 No. of shelves 9  
 Type of shelves Metal racks  
 Roof Liner No  
 No. of lights 1  
 Light type Halogen  
 Light Power 40 W  
 Door opening Side opening  
 Removable door Yes

Full glass inner door Yes  
 Removable inner door Yes  
 No. total door glasses 2  
 No. thermo-reflective door glasses 1  
 Safety Thermostat Yes  
 Cooling system Tangential  
 Usable cavity space dimensions (HxWxD) 605x375x375 mm  
 Temperature control Electro-mechanical  
 Potência da resistência circular 2 x 1550 W  
 Tilting grill No

## Options Auxiliary Oven

Timer No  
 End of cooking acoustic alarm No

Minimum Temperature 50 °C  
 Maximum temperature 245 °C

## Third Oven Technical Features



Net volume, 3rd cavity 36 l  
 Gross volume, 3rd cavity 41 l  
 Cavity material Ever Clean enamel  
 No. of shelves 2  
 Type of shelves Metal racks  
 Roof Liner No  
 No. of lights 1  
 Light type Halogen

Full glass inner door Yes  
 Removable inner door Yes  
 No. total door glasses 3  
 No. of thermo-reflective door glasses 1  
 Safety Thermostat Yes  
 Cooling system Tangential  
 Usable cavity space dimensions (HxWxD) 169x440x443 mm  
 Temperature control Electro-mechanical

Light Power	40 W	Large grill - Power	2700 W
Door opening	Flap down	Grill type	Electric
Removable door	Yes	Tilting grill	Yes

## Options Third Oven

Timer	No	Minimum Temperature	50 °C
End of cooking acoustic alarm	No	Maximum temperature	260 °C

## Accessories included for Main Oven & Hob



Rack com batente traseiro e lateral 40mm deep tray	2	Grill mesh	1
	1	Telescopic Guide rails, partial Extraction	1

## Accessories included for Secondary Oven



Oven grid with back stop	4	Plate rack/warmer	1
--------------------------	---	-------------------	---

## Accessories included for Third Oven

Rack com batente traseiro e lateral	1	40mm deep tray	1
-------------------------------------	---	----------------	---

## Electrical Connection

Plug	No	Voltage 2 (V)	380-415 V
Electrical connection rating	20000 W	Comprimento do cabo de alimentação	150 cm
Current	54 A	Frequency	50 Hz
Voltage	220-240 V	Bloco de terminais	5 polos

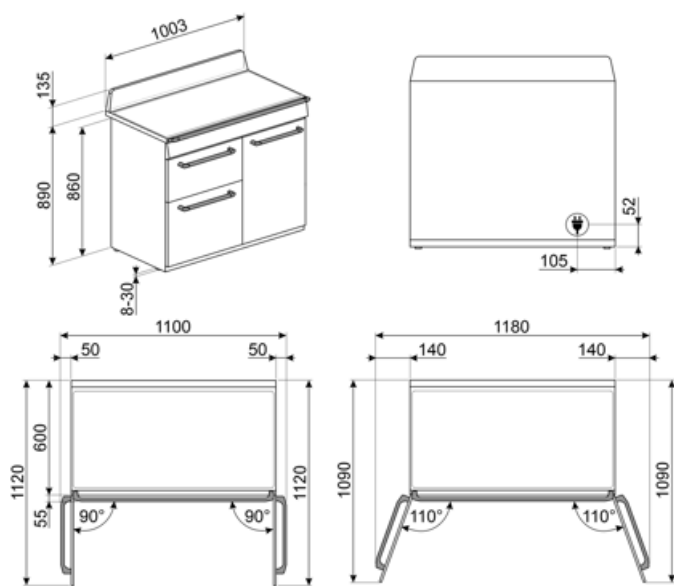

## Compatible Accessories

### AIRFRY

Air fryer rack AIRFRY . Ideal for recreating traditional frying in the oven, but with fewer calories and less fat. It allows you to cook quickly and simply dishes such as French fries, fried vegetables and fish, ensuring perfect browning and crispiness.



### BN620-1

Tabuleiro esmaltado, 20mm de profundidade



### BNP608T

Bandeja revestida de teflon, 8mm de profundidade, a ser colocada na grade



### GTP

\*\* Guias telescópicas parcialmente extraíveis (1 nível)\*\* Extração: 300 mm  
Material: Aço inoxidável AISI 430 polido



### KIT1TR103

Painel anti-salpicos 100x75 cm adequado para fogões Victoria TR103, preto



### PALPZ

Pá para pizza com alça dobrável largura: 315mm comprimento : 325mm



### SFLK1

Bloqueio para crianças



### TPKPLATE

Placa universal para placas de indução, gás, cerâmica e fogões elétricos. Superfície antiaderente ideal para cozinhar peixe, ovos e vegetais. Dimensões: 410 X 240 mm.



### BBQ

Double sided plate BBQ. Suitable for recreating succulent and crispy dishes in the oven with the typical taste of grilled cooking. The ribbed side is particularly suitable for meats and cheeses. The smooth side for fish, seafood and vegetables.



### BN640

Tabuleiro esmaltado, 40mm de profundidade

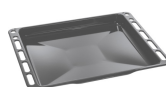

### GRILLPLATE

Placa de rede universal para indução, gás, cerâmica e fogões elétricos. Superfície antiaderente ideal para cozinhar carne, queijo e vegetais. Dimensões: 410 x 240 mm.



### GTT

\*\* Guias telescópicas totalmente extraíveis (1 nível)\*\* Extração: 433 mm  
Material: Aço inoxidável AISI 430 polido



### KITH103

Kit extensão de altura (950 mm), adequado para fogões TR103



### SCRP

Placas de indução e de cerâmica e raspador teppanyaki







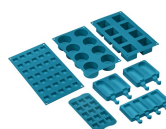











### SMOLD

Conjunto de 7 moldes de silicone para sorvetes, gelados, pralinés, cubos de gelo ou para porção de alimentos. Utilizável de -60°C a +230°C



## Symbols glossary

-  Suportes de ferro fundido para serviço pesado: para máxima estabilidade e resistência.
-  R: Desempenho de secagem do produto, medido de A++ a D/G, dependendo da família de produtos
-  Sistema de arrefecimento a ar: para garantir temperaturas de superfície seguras.
-  B: Classificação de energia do produto, medida de A+++ a D/G, dependendo da família de produtos.
-  Interior esmaltado: O interior em esmalte de todos os fornos Smeg tem um revestimento antiácido especial que ajuda a manter o interior limpo, reduzindo a quantidade de gordura de cozimento aderente a ele.
-  Somente elementos superior e inferior: um método de cozimento tradicional mais adequado para itens individuais localizados no centro do forno. A parte superior do forno será sempre mais quente. Ideal para assados, bolos de frutas, pão, etc.
-  ECO: A combinação da grelha, ventilador e elemento inferior é particularmente adequada para cozinhar pequenas quantidades de alimentos.
-  Elemento de grelha O uso de grelha dá excelentes resultados ao cozinhar carne de porções médias e pequenas, especialmente quando combinada com uma rotisseria (sempre que possível). Também é ideal para cozinhar salsichas e bacon.
-  Bloqueio para crianças: alguns modelos estão equipados com um dispositivo para bloquear o programa/ciclo para que não possa ser acidentalmente alterado.
-  Instalação em coluna: Instalação em coluna
-  Portas de vidros duplos: Número de portas envidraçadas.
-  Portas envidraçadas triplas: Número de portas envidraçadas.
-  Circogas: Em fornos a gás, o ventilador distribui o calor de forma rápida e uniforme por toda a cavidade do forno, evitando a transferência de sabor ao cozinhar vários pratos diferentes ao mesmo tempo. Em fornos elétricos, esta combinação completa o cozimento mais rapidamente de alimentos que estão prontos na superfície, mas que exigem mais cozimento no interior, sem mais escurecimento.
-  Circulaire: A combinação do ventilador e do elemento circular em torno dele dá um método de cozimento de ar quente. Isso oferece muitos benefícios, incluindo nenhum pré-aquecimento se o tempo de cozimento for superior a 20 minutos, nenhuma transferência de sabor ao cozinhar alimentos diferentes ao mesmo tempo, menos energia e tempos de cozimento mais curtos. Bom para todos os tipos de alimentos.
-  Elemento de grelha O uso de grelha dá excelentes resultados ao cozinhar carne de porções médias e pequenas, especialmente quando combinada com uma rotisseria (sempre que possível). Também é ideal para cozinhar salsichas e bacon.
-  Meia grelha: Para cozinhar rapidamente e dourar os alimentos. Os melhores resultados podem ser obtidos usando a prateleira superior para itens pequenos, as prateleiras inferiores para os maiores, como costeletas ou salsichas. Para metade do calor da grelha é gerado apenas no centro do elemento, por isso é ideal para quantidades menores.



Ventilador com elemento de grelha: O ventilador reduz o calor feroz da grelha, proporcionando um excelente método de grelhar vários alimentos, costeletas, bifés, salsichas, etc. dando o mesmo escurecimento e distribuição de calor, sem secar os alimentos. Os dois níveis superiores recomendados para uso e a parte inferior do forno podem ser usados para manter os itens quentes ao mesmo tempo, uma excelente facilidade ao cozinhar um café da manhã grelhado. Meia grelha (apenas porção central) é ideal para pequenas quantidades de alimentos.



Circulaire com elementos superior e inferior: O uso do ventilador com ambos os elementos permite que os alimentos sejam cozinhados de forma rápida e eficaz, ideal para grandes peças que exigem cozimento completo. Oferece um resultado semelhante ao da rotisseria, movendo o calor em torno do alimento, em vez de mover o próprio alimento, permitindo que qualquer tamanho ou forma seja cozida.



Toda a porta interna de vidro: Toda a porta interna de vidro, uma única superfície plana que é simples de manter limpa.



Aquecimento: Uma opção para aquecer o prato e manter as refeições preparadas quentes.



O compartimento do forno tem 4 níveis de cozimento diferentes.



Trilhos telescópicos: permitem puxar o prato e verificá-lo sem ter que removê-lo completamente do forno.



Grelha basculante: a grelha basculante pode ser facilmente desengatada para mover o elemento de aquecimento e limpar o tejadilho do aparelho em um simples passo.



A capacidade indica a quantidade de espaço útil no compartimento do forno em litros.



A capacidade indica a quantidade de espaço útil no compartimento do forno em litros.



Luz



Indução: O trabalho destas placas baseia-se no princípio da indução electromagnética. O calor é gerado diretamente na parte inferior da panela durante o seu contato com a placa.



Luzes laterais: Duas luzes laterais opostas aumentam a visibilidade dentro do forno.



O compartimento do forno tem 2 níveis de cozimento diferentes.



O compartimento do forno tem 9 níveis de cozimento diferentes.



Comando eletrônico. Permite manter a temperatura no interior do forno com a precisão de 2-3 ° C. Isso permite cozinhar refeições que são muito sensíveis a mudanças de temperatura, como por ex. bolos, suflês, pudins.



Limpeza a Vapor: uma função de limpeza simples que utiliza vapor para afrouxar os depósitos no compartimento do forno.



A capacidade indica a quantidade de espaço útil no compartimento do forno em litros.



## Benefit (TT)

---

### **Induction hob**

Induction offers fast cooking and precise temperature control

Through the use of suitable cookware, induction is easy to use and maintain, safe and responsive.

### **Vapor Clean**

By inserting water into a recess at the bottom of the cavity, steam is generated, which softens the residue and facilitates its removal

By inserting water into a recess at the bottom of the cavity, steam is generated, which softens the residue and facilitates its removal.

### **Buttons control**

Easy and intuitive timer setting with a simple buttons

### **True-convection**

The best cooking performances guaranteed by ventilated circular flow

Multiple fans and heating elements guarantee the perfect aerodynamic heat flow, allowing homogeneous and quicker cooking inside the cavity.

### **Multilevel cooking**

Several cooking levels allow maximum flexibility of use

### **Multilevel halogen light**

Internal halogen lighting on different levels guarantees excellent visibility

### **Tangential cooling**

New cooling system with tangential fan and airflow from the door to the splashback

### **Telescopic guides**

Easy extraction and safe insertion of trays into the oven thanks to telescopic guides

### **Isothermic Cavity**

The best cooking performance at the highest energy efficiency

### **BBQ (optional accessory)**

Barbeque cooking directly in the oven with the double-sided grill (BBQ optional accessory)

### **Pizza stone (optional accessory)**

Baking with refractory stone for soft and crispy pizza and yeast products (STONE optional accessory)

### **Adjustable height**

Cooker top flushed with the working area thanks to adjustable feet

### **Cold door**

During any function, the external door glass is cold, avoiding any risk of burns

### **AirFry (AIRFRY optional accessory)**

Lighter and tastier food thanks to airfry basket (optional accessory)

### **Single turbine**

The oven has a fan equipped with a circular heating element allowing cooking with rotating heat