

# TR4110AZ

Cooker size	110x60 cm
N. of cavities with energy label	2
Cavity heat source	ELECTRICITY
Hob type	Gas
Type of main oven	Thermo-ventilated
Type of second oven	Fan assisted
Cleaning system main oven	Vapor Clean
EAN code	8017709184278
Energy efficiency class	A
Energy efficiency class, second cavity	A



## Aesthetics



<b>Design</b>	Victoria	<b>Type of control knobs</b>	Smeg Victoria
<b>Command panel finish</b>	Enamelled metal	<b>Controls colour</b>	Stainless steel
<b>Aesthetic</b>	Victoria	<b>No. of controls</b>	12
<b>Logo</b>	assembled 50's	<b>Serigraphy colour</b>	Black
<b>Colour</b>	Pastel blue	<b>Display name</b>	Electronic 5 buttons
<b>Logo position</b>	Upstand	<b>Door</b>	With frame
<b>Finishing</b>	Glossy	<b>Glass type</b>	Black
<b>Upstand</b>	Yes	<b>Handle</b>	Smeg Victoria
<b>Hob colour</b>	Black enamel	<b>Handle Colour</b>	Brushed stainless steel
<b>Type of pan stands</b>	Cast Iron	<b>Storage compartment</b>	Drawer
<b>Type of control setting hob</b>	Control knobs	<b>Plinth</b>	Anthracite

## Programs / Functions main oven

No. of cooking functions 5  
Traditional cooking functions

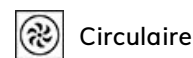

### Other functions



### Cleaning functions

 Vapor clean

## Programs / Functions auxiliary oven

Cooking functions cavity 2 5

Traditional cooking functions, cavity 2

 Static

 Fan assisted

 Circulaire

 Eco

 Fan-assisted bottom

Vapor Clean



Cleaning functions cavity 2

Other functions cavity 2

 Defrost

## Programs / Functions third oven

No. of functions third oven 1

Oven light



Full grill



## Hob technical features

**UR**

**Total no. of cook zones** 7

Left - Gas - 2UR (dual) - 4.20 kW

Front left - Gas - AUX - 1.00 kW

Rear left - Gas - Rapid - 2.90 kW

Front centre - Gas - Rapid - 2.90 kW

Rear centre - Gas - AUX - 1.00 kW

Front right - Gas - Semi Rapid - 1.80 kW

Rear right - Gas - Semi Rapid - 1.80 kW

**Type of gas burners** Standard

**Gas safety valves** Yes

**Automatic electronic ignition** Yes

**Burner caps** Matt black enamelled

## Main Oven Technical Features



**No. of lights**

1

**Total no. of door glasses** 3

<b>Net volume of the cavity</b>	61 l	<b>No. of thermo-reflective door glasses</b>	1
<b>Gross volume, 1st cavity</b>	70 l	<b>Safety Thermostat</b>	Yes
<b>Cavity material</b>	Ever Clean enamel	<b>Cooling system</b>	Tangential
<b>No. of shelves</b>	4	<b>Usable cavity space dimensions (HxWxD)</b>	316x460x412 mm
<b>Type of shelves</b>	Metal racks	<b>Temperature control</b>	Electro-mechanical
<b>Light type</b>	Halogen	<b>Lower heating element power</b>	1200 W
<b>Light Power</b>	40 W	<b>Upper heating element - Power</b>	1000 W
<b>Cooking time setting</b>	Start and Stop	<b>Grill element</b>	1700 W
<b>Door opening</b>	Side opening	<b>Large grill - Power</b>	2700 W
<b>Removable door</b>	Yes	<b>Circular heating element - Power</b>	2700 W
<b>Full glass inner door</b>	Yes	<b>Grill type</b>	Electric
<b>Removable inner door</b>	Yes		

## Options Main Oven

<b>Timer</b>	Yes	<b>Minimum Temperature</b>	50 °C
<b>End of cooking acoustic alarm</b>	Yes	<b>Maximum temperature</b>	260 °C

## Second Oven Technical Features



<b>Net volume of the second cavity</b>	61 l	<b>No. total door glasses</b>	3
<b>Gross volume, 2nd cavity</b>	70 l	<b>No. thermo-reflective door glasses</b>	1
<b>Cavity material</b>	Ever Clean enamel	<b>Safety Thermostat</b>	Yes
<b>No. of shelves</b>	4	<b>Cooling system</b>	Tangential
<b>Type of shelves</b>	Metal racks	<b>Usable cavity space dimensions (HxWxD)</b>	316x444x425 mm
<b>No. of lights</b>	1	<b>Temperature control</b>	Electro-mechanical
<b>Light type</b>	Halogen	<b>Lower heating element - power</b>	1200 W
<b>Light Power</b>	40 W	<b>Upper heating element - Power</b>	1000 W
<b>Door opening</b>	Side opening	<b>Grill element - power</b>	1700 W
<b>Removable door</b>	Yes	<b>Large grill - Power</b>	2700 W
<b>Full glass inner door</b>	Yes	<b>Grill type</b>	Electric
<b>Removable inner door</b>	Yes	<b>Tilting grill</b>	Yes

## Options Auxiliary Oven

<b>Minimum Temperature</b>	50 °C	<b>Maximum temperature</b>	260 °C
----------------------------	-------	----------------------------	--------

## Third Oven Technical Features



<b>Net volume, 3rd cavity</b>	36 l	<b>Removable inner door</b>	Yes
<b>Gross volume, 3rd cavity</b>	41 l	<b>No. total door glasses</b>	3
<b>Cavity material</b>	Ever Clean enamel	<b>No. of thermo-reflective door glasses</b>	1
<b>No. of shelves</b>	2	<b>Safety Thermostat</b>	Yes
<b>Type of shelves</b>	Metal racks	<b>Cooling system</b>	Tangential
<b>No. of lights</b>	1	<b>Usable cavity space dimensions (HxWxD)</b>	169x440x443 mm
<b>Light type</b>	Incandescent	<b>Temperature control</b>	Electro-mechanical
<b>Light Power</b>	25 W	<b>Large grill - Power</b>	2700 W
<b>Door opening</b>	Flap down	<b>Grill type</b>	Electric
<b>Removable door</b>	Yes	<b>Tilting grill</b>	Yes
<b>Full glass inner door</b>	Yes		

## Options Third Oven

<b>Minimum Temperature</b>	50 °C	<b>Maximum temperature</b>	260 °C
----------------------------	-------	----------------------------	--------

## Accessories included for Main Oven & Hob



<b>Cast iron wok support</b>	1	<b>Grill mesh</b>	1
<b>Rack with back and side stop</b>	2	<b>Telescopic Guide rails, partial Extraction</b>	1
<b>40mm deep tray</b>	1		

## Accessories included for Secondary Oven



<b>Rack with back and side stop</b>	2	<b>Grill mesh</b>	1
<b>40mm deep tray</b>	1	<b>Telescopic Guide rails, partial Extraction</b>	1

## Accessories included for Third Oven

<b>Rack with back and side stop</b>	1	<b>40mm deep tray</b>	1
-------------------------------------	---	-----------------------	---

## Electrical Connection

<b>Electrical connection rating</b>	8400 W	<b>Cable testing</b>	Yes, Single phase
<b>Current</b>	37 A	<b>Additional connection modalities</b>	Double and Three Phase
<b>Voltage</b>	220-240 V	<b>Frequency</b>	50/60 Hz
<b>Voltage 2 (V)</b>	380-415 V	<b>Terminal block</b>	5 poles
<b>Electric cable</b>	Installed, Single phase	<b>Plug</b>	Not present



## Compatible Accessories

### AIRFRY

Air fryer rack AIRFRY. Ideal for recreating traditional frying in the oven, but with fewer calories and less fat. It allows you to cook quickly and simply dishes such as French fries, fried vegetables and fish, ensuring perfect browning and crispiness.



### BBQ

Double sided plate BBQ. Suitable for recreating succulent and crispy dishes in the oven with the typical taste of grilled cooking. The ribbed side is particularly suitable for meats and cheeses. The smooth side for fish, seafood and vegetables.



### BN640

Enamelled tray suitable for 45cm and 60cm ovens. Depth 540 mm. Perfect for cooking and roasting meat and fish in sauces. Also ideal for experimenting with lighter and crunchy side dishes



### GTP

Partially extractable telescopic guides (1 level), suitable for traditional ovens. Made in stainless steel, they guarantee stability and facilitate the smooth extraction of the trays.



### KIT1TR41N

Splashback black, 110cm, suitable for TR4110 Victoria cookers



### KITH4110

Height extension kit (950mm), black, suitable for TR4110 cookers (945-965mm)



### PALPZ

Pizza shovel with folding handle. Dimensions L31.5 x H32.5 cm. Easy and convenient to use and store. Perfect for serving pizza, bread and savory pastries in a safe and professional way.



### SMOLD

Set of 7 silicone moulds for ice creams, ice lollies, pralines, ice cubes or to portion food. Usable from -60°C to +230°C

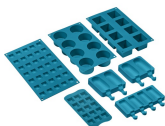

### AIRFRY2

Air fryer tray. Ideal for recreating traditional frying in the oven, but with fewer calories and less fat. It allows you to cook quickly and simply dishes such as French fries, fried vegetables and fish, ensuring perfect browning and crispiness.



### BN620-1

Enamelled tray suitable for 45 cm and 60 cm ovens. Depth 20 mm. Perfect for a wide range of savoury and sweet baking.



### BNP608T

Teflon-coated tray, 8 mm depth, to be placed on the grid



### GTT

Totally extractable telescopic guides (1 level), suitable for traditional ovens. Made in stainless steel, they guarantee stability and facilitate the smooth extraction of the trays.



### KIT600TR4110

Cover strip for hob back side, suitable for TR4110 Victoria cookers



### KITP65TR41

Depth extension kit (650 mm), black, suitable for TR4110 cookers





























### SFLK1

Child lock



## Symbols glossary

 Energy efficiency class A	 Heavy duty cast iron pan stands: for maximum stability and strength.
 Installation in column: Installation in column.	 Air cooling system: to ensure a safe surface temperatures.
 With the switch on this symbol, no heating is possible even if the thermostat is turned.	 Triple glazed doors: Number of glazed doors.
 Ever Clean Enamel: Ever Clean enamel is applied electrostatically, corner to corner and edge to edge to prevent cracking or cracks over time. It is a particular pyrolytic enamel, resistant to acids which, in addition to being pleasantly bright, promotes greater cleaning of the oven walls, thanks to its lower porosity. It is baked at over 850 °C and slowly polymerized at a scientifically determined rate to ensure uniform depth and strength. Ever Clean enamel creates an impeccable finish both on the inside of the oven and on the trays, making the surfaces of the oven incredibly easy to maintain over time as it reduces the adhesion of fat during cooking.	 Fan assisted base: the mix of fan and lower heating element alone allows to finish cooking foods already cooked on the surface but not internally more quickly. This system is recommended to finish cooking foods that are already well cooked on the surface, but not internally, which therefore require a moderate higher heat. Ideal for any type of food.
 Fan assisted: Intense and homogeneous traditional cooking, also suitable for complex recipes. The fan is active and the heat comes from below and from above at the same time. Ventilated cooking ensures a faster and more homogeneous result, leaving fragrant foods outside and moister inside. Ideal for baked pasta, biscuits, roasts and cobblers.	 Static: Traditional cooking suitable for the preparation of one dish at a time. The fan is not active and the heat comes from below and from above at the same time. Static cooking is slower and more delicate, ideal in order to get well cooked and dry dishes even inside. Ideal for cooking all types of roasts, fatty meats, bread, filled cakes.
 Circulaire: it is the perfect function for cooking all types of dishes in a more delicate way. The heat comes from the back of the oven and is distributed quickly and evenly. The fan is active. It is also ideal for cooking on multiple levels without mixing smells and flavors.	 ECO: low energy consumption cooking: this function is particularly suitable for cooking on a single shelf with low energy consumption. It is recommended for all types of food except those that can generate a lot of moisture (for example vegetables). To achieve maximum energy savings and reduce time, it is recommended to put the food in the oven without preheating the cooking compartment.
 Grill element: Using of grill gives excellent results when cooking meat of medium and small portions, especially when combined with a rotisserie (where possible). Also ideal for cooking sausages and bacon.	 Light
 All glass inner door: All glass inner door, a single flat surface which is simple to keep clean.	 The inner door glass: can be removed with a few quick movements for cleaning.
 Side lights: Two opposing side lights increase visibility inside the oven.	 The oven cavity has 2 different cooking levels.

- 
-  The oven cavity has 4 different cooking levels.
  -  Electronic control: Allows you to maintain temperature inside the oven with the precision 2-3 ° C. This enables to cook meals that are very sensitive to temperature changes, such as cakes, souffles, puddings.
  -  Ultra rapid burners: Powerful ultra rapid burners offer up to 5kw of power.
  -  The capacity indicates the amount of usable space in the oven cavity in litres.
  -  Knobs control
  -  Telescopic rails: allow you to pull out the dish and check it without having to remove it from the oven entirely.
  -  Tilting grill: the tilting grill can be easily unhooked to move the heating element and clean the roof of the appliance in one simple step.
  -  Vapor Clean: a simple cleaning function using steam to loosen deposits in the oven cavity.
  -  The capacity indicates the amount of usable space in the oven cavity in litres.

## Benefit (TT)

---

### **Gas hob**

Gas provides permanent control of the heat source and the temperature change is immediate

Equipped with a thermocouple, the gas supply is cut off if the flame is extinguished for greater safety.

### **Vapor Clean**

By inserting water into a recess at the bottom of the cavity, steam is generated, which softens the residue and facilitates its removal

By inserting water into a recess at the bottom of the cavity, steam is generated, which softens the residue and facilitates its removal.

### **Buttons control**

Easy and intuitive timer setting with a simple buttons

### **Drawer storage compartment**

More space thanks to the lower drawer compartment, ideal for storing accessories or cooking utensils

### **True-convection**

The best cooking performances guaranteed by ventilated circular flow

Multiple fans and heating elements guarantee the perfect aerodynamic heat flow, allowing homogeneous and quicker cooking inside the cavity.

### **Multilevel cooking**

Several cooking levels allow maximum flexibility of use

### **Multilevel halogen light**

Internal halogen lighting on different levels guarantees excellent visibility

### **Removable inner glass**

Internal door glasses are easily removable for complete cleaning

### **Tangential cooling**

New cooling system with tangential fan and airflow from the door to the splashback

### **Telescopic guides**

Easy extraction and safe insertion of trays into the oven thanks to telescopic guides

### **Adjustable height**

Cooker top flushed with the working area thanks to adjustable feet

### **Isothermic Cavity**

The best cooking performance at the highest energy efficiency

### **BBQ (optional accessory)**

Barbecue cooking directly in the oven with the double-sided grill (BBQ optional accessory)

### **Pizza stone (optional accessory)**

Baking with refractory stone for soft and crispy pizza and yeast products (STONE optional accessory)

### **Cold door**

During any function, the external door glass is cold, avoiding any risk of burns

### **AirFry (AIRFRY optional accessory)**

Lighter and tastier food thanks to airfry basket (optional accessory)