

TR4110AZ

Cooker size	110x60 cm
N.º de cavidades com rótulo energético	2
Fonte de calor da cavidade	ELECTRICITY
Hob type	Gas
Tipo de forno principal	Thermo-ventilated
Type of second oven	Fan assisted
Sistema de limpeza no forno principal	Vapor Clean
EAN code	8017709184278
Energy efficiency class	A
Energy efficiency class, second cavity	A



Aesthetics



Aesthetic	Victoria	Control knobs	Smeg Victoria
Design	Victoria	Controls colour	Stainless steel
Colour	Pastel blue	No. of controls	12
Acabamento	Brilhante	Cor da serigrafia	Serigrafia em preto
Command panel finish	Enamelled metal	Display	electronic 5 buttons
Logo	Logotipo Anni 50	Door	With frame
Posição do logotipo	Logotipo na zona da placa	Glass type	Black
Upstand	Yes	Handle	Smeg Victoria
Cor da placa	Esmalte preto	Handle Colour	Brushed stainless steel
Type of pan stands	Cast Iron	Storage compartment	Drawer
Type of control setting	Control knobs	Plinth	Anthracite

Programs / Functions

No. of cooking functions 5

Traditional cooking functions



Static

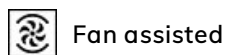

Fan assisted



Circulaire



Eco

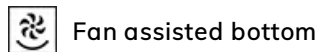

Fan assisted bottom

Other functions



Defrost

Recipes No

Cleaning functions

 Vapor clean

Programs / Functions Auxiliary Oven

Funções de cozedura cavidade 2 5
 Funções tradicionais de cozimento, cavidade 2

 Static

 Fan assisted

 Circulaire

 Eco



Parte inferior assistida por ventilador

Vapor Clean



Funções de limpeza cavidade 2
 Outras funções cavidade 2

 Defrost

Programs / Functions Third Oven

No. of functions third oven 1

Oven light 

Half grill No

Full grill 

Hob technical features

UR

Total no. of cook zones 7

Left - Gas - 2UR (dual) - 4.20 kW

Front left - Gas - AUX - 1.00 kW

Rear left - Gas - Rapid - 2.90 kW

Front centre - Gas - Rapid - 2.90 kW

Rear centre - Gas - AUX - 1.00 kW

Front right - Gas - Semi Rapid - 1.80 kW

Rear right - Gas - Semi Rapid - 1.80 kW

Type of gas burners Standard

Gas safety valves Yes

Automatic electronic ignition Yes

Burner caps Matt black enamelled

Main Oven Technical Features



No. of lights	1
Net volume of the cavity	61 l
Gross volume, 1st cavity	70 l
Cavity material	Ever Clean enamel
No. of shelves	4
Type of shelves	Metal racks
Roof Liner	No
Light type	Halogen
Light Power	40 W
Cooking time setting	Start and Stop
Door opening	Side opening
Removable door	Yes
Full glass inner door	Yes
Removable inner door	Yes

Total no. of door glasses	3
No. of thermo-reflective door glasses	1
Safety Thermostat	Yes
Cooling system	Tangential
Usable cavity space dimensions (HxWxD)	316x460x412 mm
Temperature control	Electro-mechanical
Lower heating element power	1200 W
Upper heating element - Power	1000 W
Grill element	1700 W
Large grill - Power	2700 W
Circular heating element - Power	2700 W
Grill type	Electric
Tilting grill	No

Options Main Oven

Timer	Yes	Minimum Temperature	50 °C
End of cooking acoustic alarm	Yes	Maximum temperature	260 °C

Second Oven Technical Features



Net volume of the second cavity	61 l
Gross volume, 2nd cavity	70 l
Cavity material	Ever Clean enamel
No. of shelves	4
Type of shelves	Metal racks
Roof Liner	No
No. of lights	1
Light type	Halogen
Light Power	40 W
Cooking time setting	No
Door opening	Side opening
Removable door	Yes
Full glass inner door	Yes

Removable inner door	Yes
No. total door glasses	3
No. thermo-reflective door glasses	1
Safety Thermostat	Yes
Cooling system	Tangential
Usable cavity space dimensions (HxWxD)	316x444x425 mm
Temperature control	Electro-mechanical
Lower heating element - power	1200 W
Upper heating element - Power	1000 W
Grill element - power	1700 W
Large grill - Power	2700 W
Grill type	Electric
Tilting grill	Yes

Options Auxiliary Oven

Timer	No	Minimum Temperature	50 °C
--------------	----	----------------------------	-------

End of cooking acoustic alarm No

Maximum temperature 260 °C

Third Oven Technical Features



Net volume, 3rd cavity 36 l
 Gross volume, 3rd cavity 41 l
 Cavity material Ever Clean enamel
 No. of shelves 2
 Type of shelves Metal racks
 Roof Liner No
 No. of lights 1
 Light type Incandescent
 Light Power 25 W
 Door opening Flap down
 Removable door Yes

Full glass inner door Yes
 Removable inner door Yes
 No. total door glasses 3
 No. of thermo-reflective door glasses 1
 Safety Thermostat Yes
 Cooling system Tangential
 Usable cavity space dimensions (HxWxD) 169x440x443 mm
 Temperature control Electro-mechanical
 Large grill - Power 2700 W
 Grill type Electric
 Tilting grill Yes

Options Third Oven

Timer No
 End of cooking acoustic alarm No

Minimum Temperature 50 °C
 Maximum temperature 260 °C

Accessories included for Main Oven & Hob



Cast iron wok support 1
 Rack com batente traseiro e lateral 2
 40mm deep tray 1
 Grill mesh 1
 Telescopic Guide rails, partial Extraction 1

Accessories included for Secondary Oven



Rack com batente traseiro e lateral 2
 40mm deep tray 1
 Grill mesh 1
 Telescopic Guide rails, partial Extraction 1

Accessories included for Third Oven

Rack com batente traseiro e lateral 1
 40mm deep tray 1

Electrical Connection

Plug	No	Electric cable	Installed, Single phase
Electrical connection rating	8400 W	cabo de alimentação de teste	Sim
Current	37 A	Type of electric cable	Double and Three Phase
Voltage	220-240 V	Frequency	50/60 Hz
Voltage 2 (V)	380-415 V	Bloco de terminais	5 polos

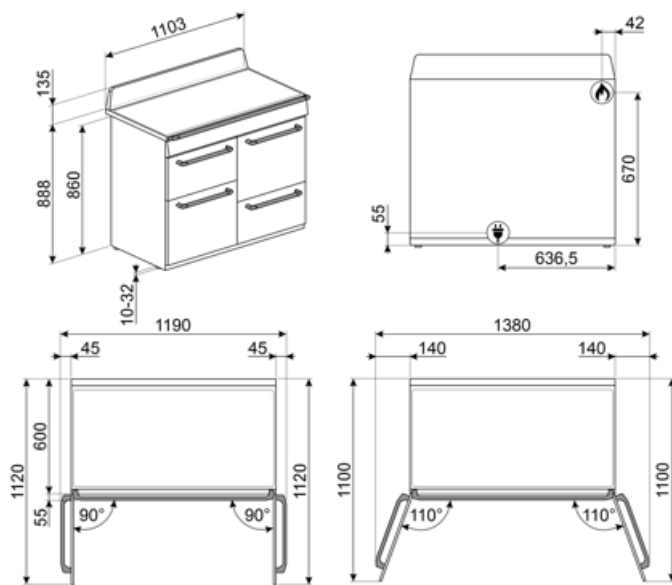

Compatible Accessories

AIRFRY

Air fryer rack AIRFRY . Ideal for recreating traditional frying in the oven, but with fewer calories and less fat. It allows you to cook quickly and simply dishes such as French fries, fried vegetables and fish, ensuring perfect browning and crispiness.



BGTR4110

Placa para grelhar de ferro fundido adequada para fogões Victoria TR4110



BN640

Tabuleiro esmaltado, 40mm de profundidade



GTP

** Guias telescópicas parcialmente extraíveis (1 nível)** Extração: 300 mm
Material: Aço inoxidável AISI 430 polido



KIT1TR41N

Painel anti-salpicos 110x75 cm adequado para fogões TR4110 Victoria, preto



KITH4110

Kit extensão de altura (950 mm), adequado para fogões TR4110



PALPZ

Pá para pizza com alça dobrável largura: 315mm comprimento : 325mm



SMOLD

Conjunto de 7 moldes de silicone para sorvetes, gelados, pralinés, cubos de gelo ou para porção de alimentos. Utilizável de -60°C a +230°C

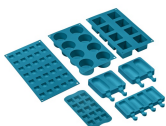

BBQ

Double sided plate BBQ. Suitable for recreating succulent and crispy dishes in the oven with the typical taste of grilled cooking. The ribbed side is particularly suitable for meats and cheeses. The smooth side for fish, seafood and vegetables.



BN620-1

Tabuleiro esmaltado, 20mm de profundidade



BNP608T

Bandeja revestida de teflon, 8mm de profundidade, a ser colocada na grade



GTT

** Guias telescópicas totalmente extraíveis (1 nível)** Extração: 433 mm
Material: Aço inoxidável AISI 430 polido



KIT600TR4110

Tira de cobertura para placa traseira, adequado para fogões Victoria TR4110



KITP65TR41

Kit extensão de profundidade (650 mm), adequado para fogões TR4110



SFLK1

Bloqueio para crianças























TPKTR

Placa grelhadora teppanyaki para fogões TR4110



Symbols glossary

 <p>R: Desempenho de secagem do produto, medido de A++ a D/G, dependendo da família de produtos</p>	 <p>Suportes de ferro fundido para serviço pesado: para máxima estabilidade e resistência.</p>
 <p>Instalação em coluna: Instalação em coluna</p>	 <p>Sistema de arrefecimento a ar: para garantir temperaturas de superfície seguras.</p>
 <p>Com o interruptor neste símbolo, nenhum aquecimento é possível mesmo se o termostato estiver ligado.</p>	 <p>Portas envidraçadas triplas: Número de portas envidraçadas.</p>
 <p>Interior esmaltado: O interior em esmalte de todos os fornos Smeg tem um revestimento antiácido especial que ajuda a manter o interior limpo, reduzindo a quantidade de gordura de cozimento aderente a ele.</p>	 <p>Circogas: Em fornos a gás, o ventilador distribui o calor de forma rápida e uniforme por toda a cavidade do forno, evitando a transferência de sabor ao cozinhar vários pratos diferentes ao mesmo tempo. Em fornos elétricos, esta combinação completa o cozimento mais rapidamente de alimentos que estão prontos na superfície, mas que exigem mais cozimento no interior, sem mais escurecimento.</p>
 <p>Ventilador com elementos superiores e inferiores: Os elementos combinados com o ventilador visam fornecer calor mais uniforme, um método semelhante ao cozimento convencional, de modo que o pré-aquecimento é necessário. Mais adequado para itens que exigem métodos de cozimento lento.</p>	 <p>Somente elementos superior e inferior: um método de cozimento tradicional mais adequado para itens individuais localizados no centro do forno. A parte superior do forno será sempre mais quente. Ideal para assados, bolos de frutas, pão, etc.</p>
 <p>Circulaire: A combinação do ventilador e do elemento circular em torno dele dá um método de cozimento de ar quente. Isso oferece muitos benefícios, incluindo nenhum pré-aquecimento se o tempo de cozimento for superior a 20 minutos, nenhuma transferência de sabor ao cozinhar alimentos diferentes ao mesmo tempo, menos energia e tempos de cozimento mais curtos. Bom para todos os tipos de alimentos.</p>	 <p>ECO: A combinação da grelha, ventilador e elemento inferior é particularmente adequada para cozinhar pequenas quantidades de alimentos.</p>
 <p>Elemento de grelha O uso de grelha dá excelentes resultados ao cozinhar carne de porções médias e pequenas, especialmente quando combinada com uma rotisseria (sempre que possível). Também é ideal para cozinhar salsichas e bacon.</p>	 <p>Luz</p>
 <p>Toda a porta interna de vidro: Toda a porta interna de vidro, uma única superfície plana que é simples de manter limpa.</p>	 <p>O vidro interior da porta: pode ser removido com alguns movimentos rápidos para limpeza.</p>
 <p>Luzes laterais: Duas luzes laterais opostas aumentam a visibilidade dentro do forno.</p>	 <p>O compartimento do forno tem 2 níveis de cozimento diferentes.</p>
 <p>O compartimento do forno tem 4 níveis de cozimento diferentes.</p>	 <p>Trilhos telescópicos: permitem puxar o prato e verificá-lo sem ter que removê-lo completamente do forno.</p>



Comando eletrônico. Permite manter a temperatura no interior do forno com a precisão de 2-3 ° C. Isso permite cozinhar refeições que são muito sensíveis a mudanças de temperatura, como por ex. bolos, suflês, pudins.



Grelha basculante: a grelha basculante pode ser facilmente desengatada para mover o elemento de aquecimento e limpar o tejadilho do aparelho em um simples passo.



Queimadores ultrarrápidos: Queimadores ultrarrápidos potentes oferecem até 5kw de potência.



Limpeza a Vapor: uma função de limpeza simples que utiliza vapor para afrouxar os depósitos no compartimento do forno.



A capacidade indica a quantidade de espaço útil no compartimento do forno em litros.



A capacidade indica a quantidade de espaço útil no compartimento do forno em litros.



Controle dos botões

Benefit (TT)

Gas hob

Gas provides permanent control of the heat source and the temperature change is immediate

Equipped with a thermocouple, the gas supply is cut off if the flame is extinguished for greater safety.

Vapor Clean

By inserting water into a recess at the bottom of the cavity, steam is generated, which softens the residue and facilitates its removal

By inserting water into a recess at the bottom of the cavity, steam is generated, which softens the residue and facilitates its removal.

Buttons control

Easy and intuitive timer setting with a simple buttons

Drawer storage compartment

More space thanks to the lower drawer compartment, ideal for storing accessories or cooking utensils

True-convection

The best cooking performances guaranteed by ventilated circular flow

Multiple fans and heating elements guarantee the perfect aerodynamic heat flow, allowing homogeneous and quicker cooking inside the cavity.

Multilevel cooking

Several cooking levels allow maximum flexibility of use

Multilevel halogen light

Internal halogen lighting on different levels guarantees excellent visibility

Removable inner glass

Internal door glasses are easily removable for complete cleaning

Tangential cooling

New cooling system with tangential fan and airflow from the door to the splashback

Telescopic guides

Easy extraction and safe insertion of trays into the oven thanks to telescopic guides

BBQ (optional accessory)

Barbeque cooking directly in the oven with the double-sided grill (BBQ optional accessory)

Pizza stone (optional accessory)

Baking with refractory stone for soft and crispy pizza and yeast products (STONE optional accessory)

Isothermic Cavity

The best cooking performance at the highest energy efficiency

Cold door

During any function, the external door glass is cold, avoiding any risk of burns

AirFry (AIRFRY optional accessory)

Lighter and tastier food thanks to airfry basket (optional accessory)

Adjustable height

Cooker top flushed with the working area thanks to adjustable feet