

TR4110BL1

Cooker size	110x60 cm
N. of cavities with energy label	2
Cavity heat source	Electric
Hob type	Gas
Type of main oven	Thermo-ventilated
Type of second oven	Fan assisted
Cleaning system main oven	Vapor Clean
EAN code	8017709176648
Energy efficiency class	A
Energy efficiency class, second cavity	A

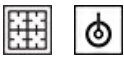

Aesthetics



Design	Victoria	Control knobs	Smeg Victoria
Command panel finish	Enamelled metal	Controls colour	Stainless steel
Aesthetics	Victoria	No. of controls	12
Logo	assembled 50's	Serigraphy colour	Silver
Colour	Black	Display	electronic 5 buttons
Logo position	Upstand	Door	With frame
Finishing	Gloss	Glass type	Black
Upstand	Yes	Handle	Smeg Victoria
Hob colour	Black enamel	Handle Colour	Brushed stainless steel
Type of pan stands	Cast Iron	Storage compartment	Drawer
Type of control setting	Control knobs	Plinth	Anthracite

Programs / Functions

No. of cooking functions 5

Traditional cooking functions



Static



Fan assisted

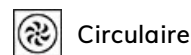

Circulaire



ECO

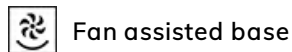

Fan assisted base

Other functions



Defrost

Cleaning functions

 Vapor Clean

Programs / Functions Auxiliary Oven

Cooking functions cavity 2 5

Traditional cooking functions, cavity 2

 Static

 Fan assisted

 Fan grill (large)

 Bottom

 Fan-assisted bottom

Vapor Clean



Cleaning functions cavity 2

Other functions cavity 2

 Defrost

Programme / Functions Third Oven

No. of functions third oven 1

Oven light 

Full grill 

Hob technical features

UR

Total no. of cook zones 7

Left - Gas - 2UR (dual) - 4.20 kW

Front left - Gas - AUX - 1.00 kW

Rear left - Gas - Rapid - 2.90 kW

Front centre - Gas - Rapid - 2.90 kW

Rear centre - Gas - AUX - 1.00 kW

Front right - Gas - Semi Rapid - 1.80 kW

Rear right - Gas - Semi Rapid - 1.80 kW

Type of gas burners Standard

Gas safety valves Yes

Automatic electronic ignition Yes

Burner caps Matte black enamelled

Main Oven Technical Features



No. of lights

1

Total no. of door glasses 3

Net volume of the cavity	61 litres	No. of thermo-reflective door glasses	1
Gross volume, 1st cavity	70 l	Safety Thermostat	Yes
Cavity material	Easy clean enamel	Cooling system	Tangential
Shelf positions	4	Usable cavity space dimensions (HxWxD)	316x460x412 mm
Type of shelves	Metal racks	Temperature control	Electro-mechanical
Light type	Halogen	Lower heating element power	1200 W
Light power	40 W	Upper heating element - Power	1000 W
Cooking time setting	Start and Stop	Grill element	1700 W
Door opening	Side opening	Large grill - Power	2700 W
Removable door	Yes	Circular heating element - Power	2700 W
Full glass inner door	Yes	Grill type	Electric
Removable inner door	Yes		

Options Main Oven

Timer	Yes	Minimum Temperature	50 °C
End of cooking acoustic alarm	Yes	Maximum temperature	260 °C

Second Oven Technical Features



Net volume of the second cavity	61 litres	No. total door glasses	3
Gross volume, 2nd cavity	70 l	No. thermo-reflective door glasses	1
Cavity material	Easy clean enamel	Safety Thermostat	Yes
Shelf positions	4	Cooling system	Tangential
Type of shelves	Metal racks	Usable cavity space dimensions (HxWxD)	316x444x425 mm
No. of lights	1	Temperature control	Electro-mechanical
Light type	Halogen	Lower heating element - power	1200 W
Light power	40 W	Upper heating element - Power	1000 W
Door opening	Side opening	Grill element - power	1700 W
Removable door	Yes	Large grill - Power	2700 W
Full glass inner door	Yes	Grill type	Electric
Removable inner door	Yes	Tilting grill	Yes

Options Auxiliary Oven

Minimum Temperature	50 °C	Maximum temperature	260 °C
----------------------------	-------	----------------------------	--------

Third Oven Technical Features



Net volume, 3rd cavity	36 l	Removable inner door	Yes
Gross volume, 3rd cavity	41 l	No. total door glasses	3
Cavity material	Easy clean enamel	No. of thermo-reflective door glasses	1
Shelf positions	2	Safety Thermostat	Yes
Type of shelves	Metal racks	Cooling system	Tangential
No. of lights	1	Usable cavity space dimensions (HxWxD)	169x440x443 mm
Light type	Incandescent	Temperature control	Electro-mechanical
Light power	25 W	Large grill - Power	2700 W
Door opening	Flap down	Grill type	Electric
Removable door	Yes	Tilting grill	Yes
Full glass inner door	Yes		

Options Third Oven

Minimum Temperature	50 °C	Maximum temperature	260 °C
----------------------------	-------	----------------------------	--------

Accessories included for Main Oven & Hob



Cast iron wok support	1	Grill mesh	1
Chrome shelf with back and side stop	2	Telescopic Guide rails, partial Extraction	1
40mm deep tray	1		

Accessories included for Secondary Oven



Chrome shelf with back and side stop	2	Grill mesh	1
40mm deep tray	1	Telescopic Guide rails, partial Extraction	1

Accessories included for Third Oven

Chrome shelf with back and side stop	1	40mm deep tray	1
---	---	-----------------------	---

Electrical Connection

Max Power Draw	8400 W	Cable testing	Yes
Current	37 A	Additional connection modalities	Yes, Double and Three Phase
Voltage	220-240 V	Frequency	50/60 Hz
Voltage 2 (V)	380-415 V	Terminal block	5 poles
Type of electric cable	Yes, Single phase		

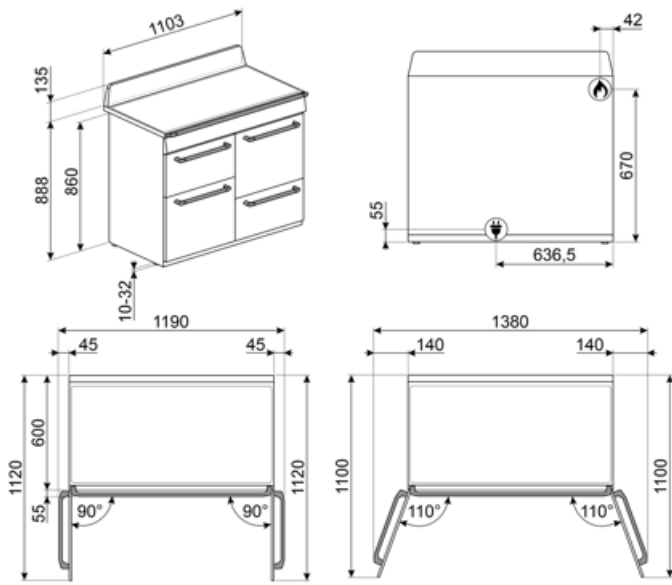

Compatible Accessories

AIRFRY

Air fryer rack AIRFRY . Ideal for recreating traditional frying in the oven, but with fewer calories and less fat. It allows you to cook quickly and simply dishes such as French fries, fried vegetables and fish, ensuring perfect browning and crispiness.



BBQ

Double sided plate BBQ. Suitable for recreating succulent and crispy dishes in the oven with the typical taste of grilled cooking. The ribbed side is particularly suitable for meats and cheeses. The smooth side for fish, seafood and vegetables.



BN620-1

Enamelled tray, 20mm deep



BNP608T

Teflon-coated tray, 8mm depth, to be placed on the grid



GTT

Totally extractable telescopic guides (1 level) Extraction: 433 mm Material: Stainless steel AISI 430 polished



KIT600TR4110

Cover strip for hob back side, suitable for TR4110 Victoria cookers



AIRFRY2

Air fryer tray. Ideal for recreating traditional frying in the oven, but with fewer calories and less fat. It allows you to cook quickly and simply dishes such as French fries, fried vegetables and fish, ensuring perfect browning and crispiness.



BGTR4110

Cast iron grill plate suitable for Victoria Cookers TR4110



BN640

Enamelled tray, 40mm deep



GTP

Partially extractable telescopic guides (1 level) Extraction: 300 mm Material: Stainless steel AISI 430 polished



KIT1TR41N

Splashback 110x75 cm suitable for TR4110 Victoria cookers, black



KITH4110

Height extension kit (950 mm), suitable for TR4110 cookers (945-965mm)



KITP65TR41

Depth extension kit (650 mm), suitable for TR4110 cookers

**SFLK1**

Child lock

**TPKTR**

Teppanyaki grill plate for TR4110 cookers

**PALPZ**







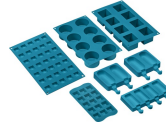













Pizza shovel with fold away handle
width: 315mm length : 325mm









**SMOLD**

Set of 7 silicone moulds for ice creams, ice lollies, pralines, ice cubes or to portion food. Usable from -60°C to +230°C



Symbols glossary

 <p>Heavy duty cast iron pan stands: for maximum stability and strength.</p>	 <p>A: Product drying performance, measured from A+++ to D / G depending on the product family</p>
 <p>Installation in column: Installation in column</p>	 <p>Air cooling system: to ensure a safe surface temperatures.</p>
 <p>With the switch on this symbol, no heating is possible even if the thermostat is turned.</p>	 <p>Triple glazed doors: Number of glazed doors.</p>
 <p>Enamel interior: The enamel interior of all Smeg ovens have a special antacid lining which helps keep the interior clean by reducing the amount of cooking grease adhering to it.</p>	 <p>Fan assisted base: the mix of fan and lower heating element alone allows to finish cooking foods already cooked on the surface but not internally more quickly. This system is recommended to finish cooking foods that are already well cooked on the surface, but not internally, which therefore require a moderate higher heat. Ideal for any type of food.</p>
 <p>Fan with upper and lower elements: The elements combined with the fan aim to provide more uniform heat, a similar method to conventional cooking, so pre-heat is required. Most suitable for items requiring slow cooking methods.</p>	 <p>Upper and lower element only: a traditional cooking method best suited for single items located in the centre of the oven. the top pf the oven will always be hottest. Ideal for roast, fruit cakes, bread etc.</p>
 <p>Lower heating element only: This function is ideal for foods that require extra base temperature without browning, e.g. pastry dishes, pizza. Also suitable for slow cooking of stews and casseroles.</p>	 <p>Circulaire: The combination of the fan and circular element around it gives a hot air cooking method. This provides many benefits including no preheat if cook time is more than 20 minutes, no flavour transfer when cooking different foods at the same time, less energy, and shorter cook times. Good for all types of food.</p>
 <p>ECO: The combination of the grill, fan and lower element is particularly suitable for cooking small quantities of food.</p>	 <p>Grill element: Using of grill gives excellent results when cooking meat of medium and small portions, especially when combined with a rotisserie (where possible). Also ideal for cooking sausages and bacon.</p>
 <p>Fan with grill element: The fan reduces the fierce heat from the grill, providing an excellent method of grilling various foods, chops, steaks, sausages etc. giving even browning and heat distribution, without drying out the food. The top two levels recommended for use, and the lower part of the oven can be used to keep items warm at the same time, an excellent facility when cooking a grilled breakfast. Half grill (centre portion only) is ideal for small quantities of food.</p>	 <p>Light</p>
 <p>All glass inner door: All glass inner door, a single flat surface which is simple to keep clean.</p>	 <p>The inner door glass: can be removed with a few quick movements for cleaning.</p>
 <p>Side lights: Two opposing side lights increase visibility inside the oven.</p>	 <p>The oven cavity has 2 different cooking levels.</p>

-
-  The oven cavity has 4 different cooking levels.
 -  Telescopic rails: allow you to pull out the dish and check it without having to remove it from the oven entirely.
 -  Electronic control: Allows you to maintain temperature inside the oven with the precision 2-3 ° C. This enables to cook meals that are very sensitive to temperature changes, such as cakes, souffles, puddings.
 -  Tilting grill: the tilting grill can be easily unhooked to move the heating element and clean the roof of the appliance in one simple step.
 -  Ultra rapid burners: Powerful ultra rapid burners offer up to 5kw of power.
 -  Vapor Clean: a simple cleaning function using steam to loosen deposits in the oven cavity.
 -  The capacity indicates the amount of usable space in the oven cavity in litres.
 -  The capacity indicates the amount of usable space in the oven cavity in litres.
 -  Knobs control

Benefit

Gas hob

Gas provides constant control of the heat source, with an immediate change in temperature

Equipped with a thermocouple, the gas supply is cut off if the flame is extinguished for greater safety

Vapor Clean

Smeg's Vapor Clean function, is an assisted steam clean program designed to help loosen food residue and spills inside the oven for easy cleaning

Smeg's Vapor Clean function, is an assisted steam clean program designed to help loosen food residue and spills inside the oven for easy cleaning

Buttons control

Easy and intuitive timer setting with a simple buttons

Drawer storage compartment

More space thanks to the lower compartment, ideal for storing accessories or cooking utensils

Circulaire

The best cooking performances guaranteed by ventilated circular flow.

Multiple fans and heating elements guarantee the perfect aerodynamic heat flow, allowing homogeneous and quicker cooking inside the cavity.

Multilevel cooking

Several cooking levels allow maximum flexibility of use

Multilevel halogen light

Internal halogen lighting on different levels guarantees excellent visibility

Removable inner glass

Internal door glasses are easily removable for complete cleaning

Tangential cooling

New cooling system with tangential fan and airflow from the door to the splashback

Telescopic guides

Easy extraction and safe insertion of trays into the oven thanks to telescopic guides

Cold door

During any function, the external door glass is cold, avoiding any risk of burns

AirFry (AIRFRY optional accessory)

Lighter and tastier food thanks to airfry basket

Pizza stone (optional accessory)

Baking with refractory stone for soft and crispy pizza and yeast products (STONE optional accessory)

BBQ (optional accessory)

Barbeque cooking directly in the oven with the double-sided grill

Adjustable height

Cooker top flushed with the working area thanks to adjustable feet

Isothermic Cavity

The best cooking performance at the highest energy efficiency