

TR4110IBL2

Cooker size	110x60 cm
N.º de cavidades com rótulo energético	2
Fonte de calor da cavidade	ELECTRICITY
Hob type	Induction
Tipo de forno principal	Thermo-ventilated
Type of second oven	Fan assisted
Sistema de limpeza no forno principal	Vapor Clean
EAN code	8017709312435
Energy efficiency class	A
Energy efficiency class, second cavity	A



Aesthetics



Aesthetic	Victoria	Controls colour	Stainless steel
Design	Victoria	No. of controls	10
Colour	Black	Cor da serigrafia	Serigrafia em prateado
Acabamento	Brilhante	Display	electronic 5 buttons
Command panel finish	Enamelled metal	Door	With frame
Logo	Logotipo Anni 50	Glass type	Black
Posição do logotipo	Logotipo na zona da placa	Handle	Smeg Victoria
Upstand	Yes	Handle Colour	Brushed stainless steel
Cor da placa	Esmalte preto	Storage compartment	Drawer
Type of control setting	Control knobs	Plinth	Anthracite
Control knobs	Smeg Victoria		

Programs / Functions

No. of cooking functions 5

Traditional cooking functions

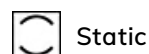

Static

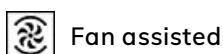

Fan assisted



Circulaire



Eco

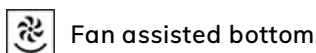

Fan assisted bottom

Other functions



Defrost by time

Cleaning functions



Programs / Functions Auxiliary Oven

Funções de cozedura cavidade 2 6

Funções tradicionais de cozimento, cavidade 2



Static

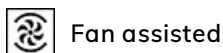

Fan assisted



Eco



Large grill



Fan grill (large)



Parte inferior assistida por ventilador

Programs / Functions Third Oven

No. of functions third oven 1

Oven light 

Half grill No

Full grill 

Hob technical features



Total no. of cook zones 5

Front left - Induction - single - 2.3 kW - Booster 3 kW - - Ø 21.0 cm

Rear left - Induction - single - 1.3 kW - Booster 1.4 kW - - Ø 18.0 cm

Central - Induction - single - 2.3 kW - Booster 3 kW - - Ø 27.0 cm

Rear right - Induction - single - 1.3 kW - Booster 1.4 kW - - Ø 18.0 cm

Front right - Induction - single - 2.3 kW - Booster 3 kW - - Ø 21.0 cm

Automatic switch off when overheat Yes Minimum pan diameter indication Yes

Automatic pan detection Yes Selected zone indicator Yes

Main Oven Technical Features



No. of lights 1 Removable inner door Yes

Fan number 1 Total no. of door glasses 3

Net volume of the cavity 61 l No. of thermo-reflective door glasses 1

Gross volume, 1st cavity 70 l Safety Thermostat Yes

Cavity material Ever Clean enamel Cooling system Tangential

No. of shelves 4

Type of shelves	Metal racks	Usable cavity space dimensions (HxWxD)	316x460x412 mm
Roof Liner	No	Temperature control	Electro-mechanical
Light type	Halogen	Lower heating element power	1200 W
Light Power	40 W	Upper heating element - Power	1000 W
Cooking time setting	Start and Stop	Grill element	1700 W
Door opening	Side opening	Large grill - Power	2700 W
Removable door	Yes	Circular heating element - Power	2700 W
Full glass inner door	Yes	Grill type	Electric
		Tilting grill	No

Options Main Oven

Timer	Yes	Minimum Temperature	50 °C
End of cooking acoustic alarm	Yes	Maximum temperature	260 °C

Second Oven Technical Features



Fan number	1	Removable inner door	Yes
Net volume of the second cavity	61 l	No. total door glasses	3
Gross volume, 2nd cavity	70 l	No. thermo-reflective door glasses	1
Cavity material	Ever Clean enamel	Safety Thermostat	Yes
No. of shelves	4	Cooling system	Tangential
Type of shelves	Metal racks	Usable cavity space dimensions (HxWxD)	316x444x425 mm
Roof Liner	No	Temperature control	Electro-mechanical
No. of lights	1	Lower heating element - power	1200 W
Light type	Halogen	Upper heating element - Power	1000 W
Light Power	40 W	Grill element - power	1700 W
Cooking time setting	No	Large grill - Power	2700 W
Door opening	Side opening	Grill type	Electric
Removable door	Yes	Tilting grill	Yes
Full glass inner door	Yes		

Options Auxiliary Oven

Timer	No	Minimum Temperature	50 °C
End of cooking acoustic alarm	No	Maximum temperature	260 °C

Third Oven Technical Features



Net volume, 3rd cavity	36 l	Full glass inner door	Yes
Gross volume, 3rd cavity	41 l	Removable inner door	Yes
Cavity material	Ever Clean enamel	No. total door glasses	3
No. of shelves	2	No. of thermo-reflective door glasses	1
Type of shelves	Metal racks	Safety Thermostat	Yes
Roof Liner	No	Cooling system	Tangential
No. of lights	1	Usable cavity space dimensions (HxWxD)	169x440x443 mm
Light type	Incandescent	Temperature control	Electro-mechanical
Light Power	25 W	Large grill - Power	2700 W
Door opening	Flap down	Grill type	Electric
Removable door	Yes	Tilting grill	Yes

Options Third Oven

Timer	No	Minimum Temperature	50 °C
End of cooking acoustic alarm	No	Maximum temperature	260 °C

Accessories included for Main Oven & Hob



Rack com batente traseiro e lateral 40mm deep tray	2	Grill mesh	1
	1	Telescopic Guide rails, partial Extraction	1

Accessories included for Secondary Oven



Rack com batente traseiro e lateral 40mm deep tray	2	Grill mesh	1
	1	Telescopic Guide rails, partial Extraction	1

Accessories included for Third Oven

Rack com batente traseiro e lateral	1	40mm deep tray	1
--	---	-----------------------	---

Electrical Connection

Plug	No	Electric cable	Installed, Single phase
Electrical connection rating	16500 W	Comprimento do cabo de alimentação	150 cm
Current	46 A	Type of electric cable	Double and Three Phase
		Frequency	50 Hz

Voltage 220-240 V
Voltage 2 (V) 380-415 V

Bloco de terminais 5 polos

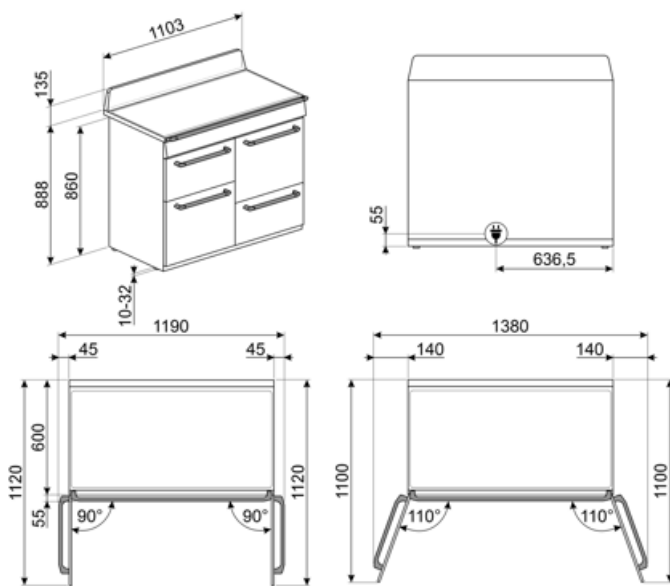

Compatible Accessories

AIRFRY

Air fryer rack AIRFRY . Ideal for recreating traditional frying in the oven, but with fewer calories and less fat. It allows you to cook quickly and simply dishes such as French fries, fried vegetables and fish, ensuring perfect browning and crispiness.



BN620-1

Tabuleiro esmaltado, 20mm de profundidade



BNP608T

Bandeja revestida de teflon, 8mm de profundidade, a ser colocada na grade



GTP

** Guias telescópicas parcialmente extraíveis (1 nível)** Extração: 300 mm
Material: Aço inoxidável AISI 430 polido



KIT1TR41N

Painel anti-salpicos 110x75 cm adequado para fogões TR4110 Victoria, preto



KITH4110

Kit extensão de altura (950 mm), adequado para fogões TR4110



PALPZ

Pá para pizza com alça dobrável largura: 315mm comprimento : 325mm



SFLK1

Bloqueio para crianças



BBQ

Double sided plate BBQ. Suitable for recreating succulent and crispy dishes in the oven with the typical taste of grilled cooking. The ribbed side is particularly suitable for meats and cheeses. The smooth side for fish, seafood and vegetables.



BN640

Tabuleiro esmaltado, 40mm de profundidade

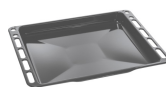

GRILLPLATE

Placa de rede universal para indução, gás, cerâmica e fogões elétricos. Superfície antiaderente ideal para cozinhar carne, queijo e vegetais. Dimensões: 410 x 240 mm.



GTT

** Guias telescópicas totalmente extraíveis (1 nível)** Extração: 433 mm
Material: Aço inoxidável AISI 430 polido



KIT600TR4110

Tira de cobertura para placa traseira, adequado para fogões Victoria TR4110



KITP65TR41

Kit extensão de profundidade (650 mm), adequado para fogões TR4110



SCRP

Placas de indução e de cerâmica e raspador teppanyaki



SMOLD

Conjunto de 7 moldes de silicone para sorvetes, gelados, pralinés, cubos de gelo ou para porção de alimentos. Utilizável de -60°C a +230°C

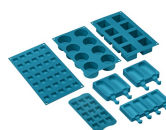































TPKPLATE



Placa universal para placas de indução, gás, cerâmica e fogões elétricos. Superfície antiaderente ideal para cozinhar peixe, ovos e vegetais. Dimensões: 410 X 240 mm.

Symbols glossary

 <p>Bloqueio para crianças: alguns modelos estão equipados com um dispositivo para bloquear o programa/ciclo para que não possa ser acidentalmente alterado.</p>	 <p>R: Desempenho de secagem do produto, medido de A++ a D/G, dependendo da família de produtos</p>
 <p>Instalação em coluna: Instalação em coluna</p>	 <p>Controle dos botões</p>
 <p>Sistema de arrefecimento a ar: para garantir temperaturas de superfície seguras.</p>	 <p>Descongela pelo tempo: com esta função, o tempo de descongelamento dos alimentos é determinado automaticamente.</p>
 <p>Portas envidraçadas triplas: Número de portas envidraçadas.</p>	 <p>ECO-logic: opção permite-lhe restringir o limite de potência da poupança de energia real do aparelho.</p>
 <p>Interior esmaltado: O interior em esmalte de todos os fornos Smeg tem um revestimento antiácido especial que ajuda a manter o interior limpo, reduzindo a quantidade de gordura de cozimento aderente a ele.</p>	 <p>Circogas: Em fornos a gás, o ventilador distribui o calor de forma rápida e uniforme por toda a cavidade do forno, evitando a transferência de sabor ao cozinhar vários pratos diferentes ao mesmo tempo. Em fornos elétricos, esta combinação completa o cozimento mais rapidamente de alimentos que estão prontos na superfície, mas que exigem mais cozimento no interior, sem mais escurecimento.</p>
 <p>Ventilador com elementos superiores e inferiores: Os elementos combinados com o ventilador visam fornecer calor mais uniforme, um método semelhante ao cozimento convencional, de modo que o pré-aquecimento é necessário. Mais adequado para itens que exigem métodos de cozimento lento.</p>	 <p>Somente elementos superior e inferior: um método de cozimento tradicional mais adequado para itens individuais localizados no centro do forno. A parte superior do forno será sempre mais quente. Ideal para assados, bolos de frutas, pão, etc.</p>
 <p>Circulaire: A combinação do ventilador e do elemento circular em torno dele dá um método de cozimento de ar quente. Isso oferece muitos benefícios, incluindo nenhum pré-aquecimento se o tempo de cozimento for superior a 20 minutos, nenhuma transferência de sabor ao cozinhar alimentos diferentes ao mesmo tempo, menos energia e tempos de cozimento mais curtos. Bom para todos os tipos de alimentos.</p>	 <p>ECO: A combinação da grelha, ventilador e elemento inferior é particularmente adequada para cozinhar pequenas quantidades de alimentos.</p>
 <p>Elemento de grelha O uso de grelha dá excelentes resultados ao cozinhar carne de porções médias e pequenas, especialmente quando combinada com uma rotisseria (sempre que possível). Também é ideal para cozinhar salsichas e bacon.</p>	 <p>Elemento de grelha O uso de grelha dá excelentes resultados ao cozinhar carne de porções médias e pequenas, especialmente quando combinada com uma rotisseria (sempre que possível). Também é ideal para cozinhar salsichas e bacon.</p>

-  Ventilador com elemento de grelha: O ventilador reduz o calor feroz da grelha, proporcionando um excelente método de grelhar vários alimentos, costeletas, bifés, salsichas, etc. dando o mesmo escurecimento e distribuição de calor, sem secar os alimentos. Os dois níveis superiores recomendados para uso e a parte inferior do forno podem ser usados para manter os itens quentes ao mesmo tempo, uma excelente facilidade ao cozinhar um café da manhã grelhado. Meia grelha (apenas porção central) é ideal para pequenas quantidades de alimentos.
-  Protecção contra o sobreaquecimento: O sistema de segurança que desliga automaticamente a placa em caso de sobreaquecimento da unidade de controle.
-  Toda a porta interna de vidro: Toda a porta interna de vidro, uma única superfície plana que é simples de manter limpa.
-  Luzes laterais: Duas luzes laterais opostas aumentam a visibilidade dentro do forno.
-  O compartimento do forno tem 4 níveis de cozimento diferentes.
-  Comando eletrônico. Permite manter a temperatura no interior do forno com a precisão de 2-3 ° C. Isso permite cozinhar refeições que são muito sensíveis a mudanças de temperatura, como por ex. bolos, suflês, pudins.
-  Limpeza a Vapor: uma função de limpeza simples que utiliza vapor para afrouxar os depósitos no compartimento do forno.
-  A capacidade indica a quantidade de espaço útil no compartimento do forno em litros.
-  Luz
-  Indução: O trabalho destas placas baseia-se no princípio da indução electromagnética. O calor é gerado diretamente na parte inferior da panela durante o seu contato com a placa.
-  O vidro interior da porta: pode ser removido com alguns movimentos rápidos para limpeza.
-  O compartimento do forno tem 2 níveis de cozimento diferentes.
-  Trilhos telescópicos: permitem puxar o prato e verificá-lo sem ter que removê-lo completamente do forno.
-  Grelha basculante: a grelha basculante pode ser facilmente desengatada para mover o elemento de aquecimento e limpar o tejadilho do aparelho em um simples passo.
-  A capacidade indica a quantidade de espaço útil no compartimento do forno em litros.

Benefit (TT)

Induction hob

Induction offers fast cooking and precise temperature control

Through the use of suitable cookware, induction is easy to use and maintain, safe and responsive.

Vapor Clean

By inserting water into a recess at the bottom of the cavity, steam is generated, which softens the residue and facilitates its removal

By inserting water into a recess at the bottom of the cavity, steam is generated, which softens the residue and facilitates its removal.

Buttons control

Easy and intuitive timer setting with a simple buttons

Drawer storage compartment

More space thanks to the lower drawer compartment, ideal for storing accessories or cooking utensils

True-convection

The best cooking performances guaranteed by ventilated circular flow

Multiple fans and heating elements guarantee the perfect aerodynamic heat flow, allowing homogeneous and quicker cooking inside the cavity.

Multilevel cooking

Several cooking levels allow maximum flexibility of use

Multilevel halogen light

Internal halogen lighting on different levels guarantees excellent visibility

Removable inner glass

Internal door glasses are easily removable for complete cleaning

Tangential cooling

New cooling system with tangential fan and airflow from the door to the splashback

Telescopic guides

Easy extraction and safe insertion of trays into the oven thanks to telescopic guides

Isothermic Cavity

The best cooking performance at the highest energy efficiency

Adjustable height

Cooker top flushed with the working area thanks to adjustable feet

BBQ (optional accessory)

Barbeque cooking directly in the oven with the double-sided grill (BBQ optional accessory)

Pizza stone (optional accessory)

Baking with refractory stone for soft and crispy pizza and yeast products (STONE optional accessory)

Cold door

During any function, the external door glass is cold, avoiding any risk of burns

AirFry (AIRFRY optional accessory)

Lighter and tastier food thanks to airfry basket (optional accessory)

Single turbine

The oven has a fan equipped with a circular heating element allowing cooking with rotating heat