

# TR4110IP2

Categorie fornuis	110x60 cm
N. of cavities with energy label	2
Cavity heat source	Elektriciteit
Type kookplaat	Inductie
Type primaire oven	Thermogeventileerd
Type secundaire oven	Geventileerd
Reinigingssysteem primaire oven	Vapor Clean reiniging
EAN-code	8017709312442
Energie-efficiëntieklasse	A
Energie-efficiëntieklasse, tweede oven	A



## Design

			
<b>Design</b>	Victoria	<b>Kleur</b>	Inox
<b>Afwerking bedieningspaneel</b>	Gekleurd plaatstaal	<b>bedieningsknoppen</b>	
<b>Design</b>	Victoria	<b>Aantal bedieningsknoppen</b>	10
<b>Logo</b>	assembled 50's	<b>Kleur serigrafie</b>	Zwart
<b>Kleur</b>	Crème	<b>Display</b>	Elektronisch 5 toetsen
<b>Positie logo</b>	Upstand	<b>Deur</b>	Met kader
<b>Afwerking</b>	Glanzend	<b>Type glas</b>	Zwart
<b>Upstand</b>	Ja	<b>Handgreep</b>	Smeg Victoria
<b>Kleur kookplaat</b>	Black enamel	<b>Kleur handgreep</b>	Geborsteld inox
<b>Bediening</b>	Bedieningsknoppen	<b>Opbergruimte</b>	Opbergvak met lade
<b>Bedieningsknoppen</b>	Smeg Victoria	<b>Plint</b>	Antraciet

## Programma's / Functies

<b>Aantal kookfuncties</b>	5
<b>Traditionele bereidingsfuncties</b>	



Statisch



Geventileerd



Circulatie (ventilator + circulaire)



ECO



Geventileerde onderwarmte

### Overige functies

 Ontdooien op tijd

### Reinigingsfuncties

 Vapor Clean reiniging

## Programma's / Functies secundaire oven

Aantal kookfuncties 6

Traditionele bereidingsfuncties, 2e oven

 Statisch

 Geventileerd

 ECO

 Grote grill

 Ventilator + grote grill

 Geventileerde onderwarmte

Reinigingsfunctie 2e oven

 Vapor Clean reiniging

## Programma's / Functies derde oven

Aantal functies derde oven 1

Licht 

Grote vlakgrill 

## Technische specificaties kookplaat



Totaal aantal kookzones 5

Linksvoor - Inductie - enkel - 2.3 kW - Booster 3 kW - - Ø 21.0 cm

Linksachter - Inductie - enkel - 1.3 kW - Booster 1.4 kW - - Ø 18.0 cm

Midden - Inductie - enkel - 2.3 kW - Booster 3 kW - - Ø 27.0 cm

Rechtsachter - Inductie - enkel - 1.3 kW - Booster 1.4 kW - - Ø 18.0 cm

Rechtsvoor - Inductie - enkel - 2.3 kW - Booster 3 kW - - Ø 21.0 cm

Automatisch uitschakelen i.g.v. oververhitting Ja Indicator minimaal te gebruiken diameter Ja

Automatische aanpassing panafmeting Ja Indicator geselecteerde zone Ja

## Technische specificaties primaire oven



<b>Aantal lampen</b>	1	<b>Uitneembaar glas binnendeur</b>	Ja
<b>Aantal ventilatoren</b>	1	<b>Aantal ruiten ovendeur</b>	3
<b>Netto volume 1e oven</b>	61 l	<b>Aantal thermo-reflecterende ruiten</b>	1
<b>Bruto volume, oven 1</b>	70 l	<b>Veiligheidsthermostaat</b>	Ja
<b>Materiaal ovenruimte</b>	Ever Clean emaille	<b>Koelsysteem</b>	Mantelkoeling
<b>Aantal kookniveaus</b>	4	<b>Afmetingen bruikbare interne ovenruimte (hxbxd)</b>	316x460x412 mm
<b>Type ovenrekken</b>	Metalen zijsteunen	<b>Temperatuurregeling</b>	Elektro-mechanisch
<b>Type licht</b>	Halogeen	<b>Onderwarmte - vermogen</b>	1200 W
<b>Vermogen lamp</b>	40 W	<b>Bovenwarmte - vermogen</b>	1000 W
<b>Opties bereidingstijdprogrammering</b>	Begin en eind	<b>Grill - vermogen</b>	1700 W
<b>Opening deur</b>	Side opening	<b>Grote vlakgrill - vermogen</b>	2700 W
<b>Uitneembare ovendeur</b>	Ja	<b>Circulatie - vermogen</b>	2700 W
<b>Volledig glazen binnendeur</b>	Ja	<b>Grill type</b>	Elektrisch

## Opties primaire oven

<b>Timer</b>	Ja	<b>Minimum temperatuur</b>	50 °C
<b>Geluidssignaal einde kooktijd</b>	Ja	<b>Maximum temperatuur</b>	260 °C

## Technische specificaties secundaire oven



<b>Aantal ventilatoren</b>	1	<b>Aantal ruiten ovendeur</b>	3
<b>Netto volume 2e oven</b>	61 l	<b>Aantal thermo-reflecterende ruiten</b>	1
<b>Bruto volume, oven 2</b>	70 l	<b>Veiligheidsthermostaat</b>	Ja
<b>Materiaal ovenruimte</b>	Ever Clean emaille	<b>Koelsysteem</b>	Mantelkoeling
<b>Aantal kookniveaus</b>	4	<b>Afmetingen bruikbare interne ovenruimte (hxbxd)</b>	316x444x425 mm
<b>Type ovenrekken</b>	Metalen zijsteunen	<b>Temperatuurregeling</b>	Elektro-mechanisch
<b>Aantal lampen</b>	1	<b>Onderwarmte - vermogen</b>	1200 W
<b>Type lamp</b>	Halogeen	<b>Bovenwarmte - vermogen</b>	1000 W
<b>Vermogen lamp</b>	40 W	<b>Grill - vermogen</b>	1700 W
<b>Opening deur</b>	Side opening	<b>Grote vlakgrill - vermogen</b>	2700 W
<b>Uitneembare ovendeur</b>	Ja	<b>Type grill</b>	Elektrisch
<b>Volledig glazen binnendeur</b>	Ja	<b>Kantelbare grill</b>	Ja
<b>Uitneembaar glas binnendeur</b>	Ja		

## Opties secundaire oven

Minimum temperatuur 50 °C

Maximum temperatuur 260 °C

## Technische specificaties derde oven



<b>Netto volume, 3e oven</b>	36 l	<b>Uitneembaar glas binnendeur</b>	Ja
<b>Bruto volume, oven 3</b>	41 l	<b>Aantal ruiten ovendeur</b>	3
<b>Materiaal ovenruimte</b>	Ever Clean emaille	<b>Aantal thermo-reflecterende ruiten</b>	1
<b>Aantal kookniveaus</b>	2	<b>Veiligheidsthermostaat</b>	Ja
<b>Type ovenrekken</b>	Metalen zijsteunen	<b>Koelsysteem</b>	Mantelkoeling
<b>Aantal lampen</b>	1	<b>Afmetingen bruikbare interne ovenruimte (hxbxd)</b>	169x440x443 mm
<b>Type lamp</b>	Gloeilamp	<b>Temperatuurregeling</b>	Elektro-mechanisch
<b>Vermogen lamp</b>	25 W	<b>Grote vlakgrill - vermogen</b>	2700 W
<b>Opening deur</b>	Neerwaarts	<b>Type grill</b>	Elektrisch
<b>Uitneembare ovendeur</b>	Ja	<b>Kantelbare grill</b>	Ja
<b>Volledig glazen binnendeur</b>	Ja		

## Opties derde oven

Minimum temperatuur 50 °C

Maximum temperatuur 260 °C

## Meegeleverde accessoires primaire oven en kookplaat



<b>Ovenrooster met stop</b>	2	<b>Inzetrooster</b>	1
<b>Bakplaat (40 mm)</b>	1	<b>Telescopische geleiders, gedeeltelijk uitschuifbaar</b>	1

## Meegeleverde accessoires secundaire oven



<b>Ovenrooster met stop</b>	2	<b>Inzetrooster</b>	1
<b>Bakplaat (40 mm)</b>	1	<b>Telescopische geleiders, gedeeltelijk uitschuifbaar</b>	1

## Meegeleverde accessoires derde oven

<b>Ovenrooster met stop</b>	1	<b>Bakplaat (40 mm)</b>	1
-----------------------------	---	-------------------------	---

## Elektrische aansluiting

<b>Nominale aansluitwaarde</b>	16500 W	<b>Lengte voedingskabel</b>	150 cm
<b>Stroom</b>	46 A	<b>Type stroomkabel</b>	Double and Three Phase
<b>Spanning</b>	220-240 V	<b>Frequentie</b>	50 Hz
<b>Spanning 2 (V)</b>	380-415 V	<b>Connection box</b>	5 polig
<b>Electric cable</b>	Installed, Single phase	<b>Stekker</b>	Nee

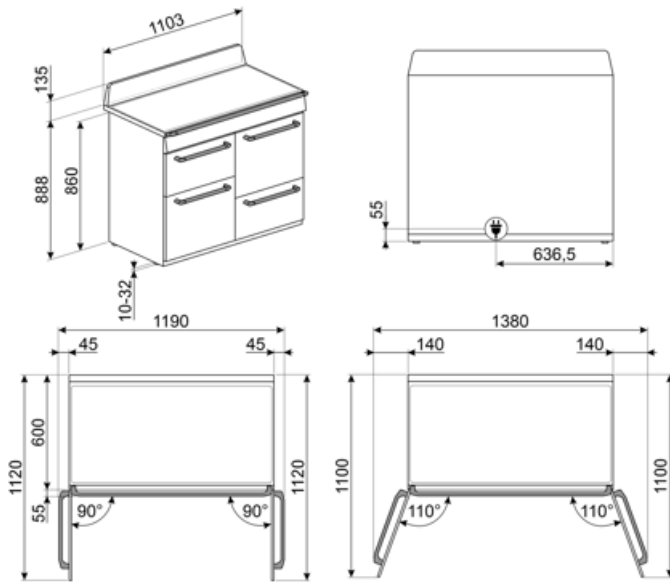

## Compatible Accessories

### AIRFRY



### BBQ

Dubbelzijdig



### BN640

Enamelled tray suitable for 45cm and 60cm ovens. Depth 540 mm. Perfect for cooking and roasting meat and fish in sauces. Also ideal for experimenting with lighter and crunchy side dishes

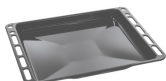

### GRILLPLATE

Universal griddle for induction, gas, ceramic and electric hobs. Non-stick surface ideal for cooking meat, cheese and vegetables. Dimensions: 410 x 240 mm.



### GTT

Volledig uitschuifbare telescopische rails (1 niveau) voor traditionele ovens (SF-).



### KIT600TR4110

Cover strip for hob back side, suitable for TR4110 Victoria cookers



### KITP65TR41

Depth extension kit (650 mm), black, suitable for TR4110 cookers



### SCRP

Schraper voor inductie- en vitrokeramische kookplaten



### AIRFRY2

Air fryer tray. Ideal for recreating traditional frying in the oven, but with fewer calories and less fat. It allows you to cook quickly and simply dishes such as French fries, fried vegetables and fish, ensuring perfect browning and crispiness.



### BN620-1

Enamelled tray suitable for 45 cm and 60 cm ovens. Depth 20 mm. Perfect for a wide range of savoury and sweet baking.



### BNP608T

Teflon bakplaat, 8mm diep



### GTP

Partially extractable telescopic guides (1 level), suitable for traditional ovens. Made in stainless steel, they guarantee stability and facilitate the smooth extraction of the trays.



### KIT1TR41N

Splashback black, 110cm, suitable for TR4110 Victoria cookers



### KITH4110

Height extension kit (950mm), black, suitable for TR4110 cookers (945-965mm)



### PALPZ

Pizzapallet inox met plooibaar handvat, 315x325 mm



### SFLK1

Child lock





### SMOLD

















Set van 7 siliconen vormen voor ijsjes, pralines, ijsblokjes of porties. -60°C tot 230°C.

















### TPKPLATE

Universal plate for induction, gas, ceramic and electric hobs. Non-stick surface ideal for cooking fish, eggs and vegetables. Dimensions: 410 X 240 mm.

## Symbols glossary

 Energy efficiency class A	 Sommige modellen zijn voorzien van een functie om het programma/de cyclus te blokkeren zodat het niet per ongeluk kan aangepast worden.
 Installation in column: Installation in column.	 Air cooling system: to ensure a safe surface temperatures.
 Defrost by time: Manual defrost function. At the end of the set duration, the function stops.	 Triple glazed doors: Number of glazed doors.
 ECO-logic: option allows you to restrict the power limit of the appliance real energy saving.	 Ever Clean Enamel: Ever Clean enamel is applied electrostatically, corner to corner and edge to edge to prevent cracking or cracks over time. It is a particular pyrolytic enamel, resistant to acids which, in addition to being pleasantly bright, promotes greater cleaning of the oven walls, thanks to its lower porosity. It is baked at over 850 °C and slowly polymerized at a scientifically determined rate to ensure uniform depth and strength. Ever Clean enamel creates an impeccable finish both on the inside of the oven and on the trays, making the surfaces of the oven incredibly easy to maintain over time as it reduces the adhesion of fat during cooking.
 Circogas: In gasovens verdeelt de ventilator de warmte snel en gelijkmatig over de ovenruimte, waardoor smaakoverdracht wordt vermeden bij het tegelijkertijd bereiden van een aantal verschillende gerechten. In elektrische ovens voltooit deze combinatie het koken van voedsel dat aan de oppervlakte klaar is, maar dat van binnen meer moet worden gekookt, zonder verder bruin te worden.	 Ventilator met bovenste en onderste elementen: De elementen in combinatie met de ventilator zijn bedoeld om een meer gelijkmatige warmte te bieden, een methode die vergelijkbaar is met conventioneel koken, dus voorverwarmen is vereist. Het meest geschikt voor items die langzaam koken vereisen.
 Alleen boven- en onder element: een traditionele kookmethode die het meest geschikt is voor losse items in het midden van de oven. de bovenkant van de oven zal altijd het heetst zijn. Ideaal voor gebraden vlees, fruitcake, brood etc.	 Circulaire: De combinatie van de ventilator en het ronde element eromheen zorgt voor een hete lucht kookmethode. Dit biedt vele voordelen, waaronder geen voorverwarmen als de kooktijd meer dan 20 minuten bedraagt, geen smaakoverdracht bij het gelijktijdig bereiden van verschillende soorten voedsel, minder energie en kortere kooktijden. Geschikt voor alle soorten voedsel.
 De combinatie van de grill, de ventilator en onderwarmte is interessant voor het bereiden van kleine hoeveelheden.	 Grill: Very intense heat coming only from above from a double heating element. The fan is not active. Provides excellent grilling and gratinating results. Used at the end of cooking, it gives a uniform browning to dishes.
 Grill element: Using of grill gives excellent results when cooking meat of medium and small portions, especially when combined with a rotisserie (where possible). Also ideal for cooking sausages and bacon.	 Fan grill: very intense heat coming only from above from a double heating element. The fan is active. It allows the optimal grilling of thickest meats. Ideal for large cuts of meat.

- 
-  Light
  -  Overheat protection: The safety system that automatically turns off the hob in case of overheating of the control unit.
  -  Induction: The work of these hobs is based on the principle of electromagnetic induction. The heat is generated directly in the bottom of the pan during its contact with the hob.
  -  All glass inner door: All glass inner door, a single flat surface which is simple to keep clean.
  -  The inner door glass: can be removed with a few quick movements for cleaning.
  -  Side lights: Two opposing side lights increase visibility inside the oven.
  -  The oven cavity has 2 different cooking levels.
  -  The oven cavity has 4 different cooking levels.
  -  Telescopic rails: allow you to pull out the dish and check it without having to remove it from the oven entirely.
  -  Electronic control: Allows you to maintain temperature inside the oven with the precision 2-3 ° C. This enables to cook meals that are very sensitive to temperature changes, such as cakes, souffles, puddings.
  -  Tilting grill: the tilting grill can be easily unhooked to move the heating element and clean the roof of the appliance in one simple step.
  -  Vapor Clean: a simple cleaning function using steam to loosen deposits in the oven cavity.
  -  The capacity indicates the amount of usable space in the oven cavity in litres.
  -  The capacity indicates the amount of usable space in the oven cavity in litres.
  -  Knobs control

## Benefit (TT)

---

### **Induction hob**

Induction offers fast cooking and precise temperature control

Through the use of suitable cookware, induction is easy to use and maintain, safe and responsive.

### **Vapor Clean**

By inserting water into a recess at the bottom of the cavity, steam is generated, which softens the residue and facilitates its removal

By inserting water into a recess at the bottom of the cavity, steam is generated, which softens the residue and facilitates its removal.

### **Buttons control**

Easy and intuitive timer setting with a simple buttons

### **Drawer storage compartment**

More space thanks to the lower drawer compartment, ideal for storing accessories or cooking utensils

### **True-convection**

The best cooking performances guaranteed by ventilated circular flow

Multiple fans and heating elements guarantee the perfect aerodynamic heat flow, allowing homogeneous and quicker cooking inside the cavity.

### **Multilevel cooking**

Several cooking levels allow maximum flexibility of use

### **Multilevel halogen light**

Internal halogen lighting on different levels guarantees excellent visibility

### **Removable inner glass**

Internal door glasses are easily removable for complete cleaning

### **Tangential cooling**

New cooling system with tangential fan and airflow from the door to the splashback

### **Telescopic guides**

Easy extraction and safe insertion of trays into the oven thanks to telescopic guides

### **Adjustable height**

Cooker top flushed with the working area thanks to adjustable feet

### **Isothermic Cavity**

The best cooking performance at the highest energy efficiency

### **BBQ (optional accessory)**

Barbecue cooking directly in the oven with the double-sided grill (BBQ optional accessory)

### **Pizza stone (optional accessory)**

Baking with refractory stone for soft and crispy pizza and yeast products (STONE optional accessory)

### **Cold door**

During any function, the external door glass is cold, avoiding any risk of burns

### **AirFry (AIRFRY optional accessory)**

Lighter and tastier food thanks to airfry basket (optional accessory)

### **Single turbine**

The oven has a fan equipped with a circular heating element allowing cooking with rotating heat