

# TR4110IP2

Cooker size	110x60 cm
N.º de cavidades com rótulo energético	2
Fonte de calor da cavidade	ELECTRICITY
Hob type	Induction
Tipo de forno principal	Thermo-ventilated
Type of second oven	Fan assisted
Sistema de limpeza no forno principal	Vapor Clean
EAN code	8017709312442
Energy efficiency class	A
Energy efficiency class, second cavity	A



## Aesthetics



<b>Aesthetic</b>	Victoria	<b>Controls colour</b>	Stainless steel
<b>Design</b>	Victoria	<b>No. of controls</b>	10
<b>Colour</b>	Cream	<b>Cor da serigrafia</b>	Serigrafia em preto
<b>Acabamento</b>	Brilhante	<b>Display</b>	electronic 5 buttons
<b>Command panel finish</b>	Enamelled metal	<b>Door</b>	With frame
<b>Logo</b>	Logotipo Anni 50	<b>Glass type</b>	Black
<b>Posição do logotipo</b>	Logotipo na zona da placa	<b>Handle</b>	Smeg Victoria
<b>Upstand</b>	Yes	<b>Handle Colour</b>	Brushed stainless steel
<b>Cor da placa</b>	Esmalte preto	<b>Storage compartment</b>	Drawer
<b>Type of control setting</b>	Control knobs	<b>Plinth</b>	Anthracite
<b>Control knobs</b>	Smeg Victoria		

## Programs / Functions

No. of cooking functions 5

Traditional cooking functions



Static

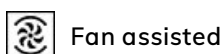

Fan assisted



Circulaire



Eco

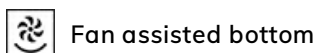

Fan assisted bottom

Other functions



Defrost by time

Recipes No

### Cleaning functions

 Vapor clean

## Programs / Functions Auxiliary Oven

Funções de cozedura cavidade 2 6

Funções tradicionais de cozimento, cavidade 2

 Static

 Fan assisted

 Eco

 Large grill

 Fan grill (large)



Parte inferior assistida por ventilador

Funções de limpeza cavidade 2

 Vapor clean

## Programs / Functions Third Oven

No. of functions third oven 1

Oven light 

Half grill No

Full grill 

## Hob technical features



**Total no. of cook zones** 5

Front left - Induction - single - 2.3 kW - Booster 3 kW - - Ø 21.0 cm

Rear left - Induction - single - 1.3 kW - Booster 1.4 kW - - Ø 18.0 cm

Central - Induction - single - 2.3 kW - Booster 3 kW - - Ø 27.0 cm

Rear right - Induction - single - 1.3 kW - Booster 1.4 kW - - Ø 18.0 cm

Front right - Induction - single - 2.3 kW - Booster 3 kW - - Ø 21.0 cm

**Automatic switch off when overheat** Yes **Minimum pan diameter indication** Yes

**Automatic pan detection** Yes **Selected zone indicator** Yes

## Main Oven Technical Features

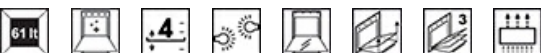

**No. of lights** 1

**Removable inner door** Yes

**Fan number** 1

**Total no. of door glasses** 3

**Net volume of the cavity** 61 l

<b>Gross volume, 1st cavity</b>	70 l	<b>No. of thermo-reflective door glasses</b>	1
<b>Cavity material</b>	Ever Clean enamel	<b>Safety Thermostat</b>	Yes
<b>No. of shelves</b>	4	<b>Cooling system</b>	Tangential
<b>Type of shelves</b>	Metal racks	<b>Usable cavity space dimensions (HxWxD)</b>	316x460x412 mm
<b>Roof Liner</b>	No	<b>Temperature control</b>	Electro-mechanical
<b>Light type</b>	Halogen	<b>Lower heating element power</b>	1200 W
<b>Light Power</b>	40 W	<b>Upper heating element - Power</b>	1000 W
<b>Cooking time setting</b>	Start and Stop	<b>Grill element</b>	1700 W
<b>Door opening</b>	Side opening	<b>Large grill - Power</b>	2700 W
<b>Removable door</b>	Yes	<b>Circular heating element - Power</b>	2700 W
<b>Full glass inner door</b>	Yes	<b>Grill type</b>	Electric
		<b>Tilting grill</b>	No

## Options Main Oven

<b>Timer</b>	Yes	<b>Minimum Temperature</b>	50 °C
<b>End of cooking acoustic alarm</b>	Yes	<b>Maximum temperature</b>	260 °C

## Second Oven Technical Features



<b>Fan number</b>	1	<b>Removable inner door</b>	Yes
<b>Net volume of the second cavity</b>	61 l	<b>No. total door glasses</b>	3
<b>Gross volume, 2nd cavity</b>	70 l	<b>No. thermo-reflective door glasses</b>	1
<b>Cavity material</b>	Ever Clean enamel	<b>Safety Thermostat</b>	Yes
<b>No. of shelves</b>	4	<b>Cooling system</b>	Tangential
<b>Type of shelves</b>	Metal racks	<b>Usable cavity space dimensions (HxWxD)</b>	316x444x425 mm
<b>Roof Liner</b>	No	<b>Temperature control</b>	Electro-mechanical
<b>No. of lights</b>	1	<b>Lower heating element - power</b>	1200 W
<b>Light type</b>	Halogen	<b>Upper heating element - Power</b>	1000 W
<b>Light Power</b>	40 W	<b>Grill element - power</b>	1700 W
<b>Cooking time setting</b>	No	<b>Large grill - Power</b>	2700 W
<b>Door opening</b>	Side opening	<b>Grill type</b>	Electric
<b>Removable door</b>	Yes	<b>Tilting grill</b>	Yes
<b>Full glass inner door</b>	Yes		

## Options Auxiliary Oven

<b>Timer</b>	No	<b>Minimum Temperature</b>	50 °C
<b>End of cooking acoustic alarm</b>	No	<b>Maximum temperature</b>	260 °C

## Third Oven Technical Features



<b>Net volume, 3rd cavity</b>	36 l	<b>Full glass inner door</b>	Yes
<b>Gross volume, 3rd cavity</b>	41 l	<b>Removable inner door</b>	Yes
<b>Cavity material</b>	Ever Clean enamel	<b>No. total door glasses</b>	3
<b>No. of shelves</b>	2	<b>No. of thermo-reflective door glasses</b>	1
<b>Type of shelves</b>	Metal racks	<b>Safety Thermostat</b>	Yes
<b>Roof Liner</b>	No	<b>Cooling system</b>	Tangential
<b>No. of lights</b>	1	<b>Usable cavity space dimensions (HxWxD)</b>	169x440x443 mm
<b>Light type</b>	Incandescent	<b>Temperature control</b>	Electro-mechanical
<b>Light Power</b>	25 W	<b>Large grill - Power</b>	2700 W
<b>Door opening</b>	Flap down	<b>Grill type</b>	Electric
<b>Removable door</b>	Yes	<b>Tilting grill</b>	Yes

## Options Third Oven

<b>Timer</b>	No	<b>Minimum Temperature</b>	50 °C
<b>End of cooking acoustic alarm</b>	No	<b>Maximum temperature</b>	260 °C

## Accessories included for Main Oven & Hob



<b>Rack com batente traseiro e lateral</b>	2	<b>Grill mesh</b>	1
<b>40mm deep tray</b>	1	<b>Telescopic Guide rails, partial Extraction</b>	1

## Accessories included for Secondary Oven



<b>Rack com batente traseiro e lateral</b>	2	<b>Grill mesh</b>	1
<b>40mm deep tray</b>	1	<b>Telescopic Guide rails, partial Extraction</b>	1

## Accessories included for Third Oven

<b>Rack com batente traseiro e lateral</b>	1	<b>40mm deep tray</b>	1
--	---	-----------------------	---

## Electrical Connection

Plug	No	Electric cable	Installed, Single phase
Electrical connection rating	16500 W	Comprimento do cabo de alimentação	150 cm
Current	46 A	Type of electric cable	Double and Three Phase
Voltage	220-240 V	Frequency	50 Hz
Voltage 2 (V)	380-415 V	Bloco de terminais	5 polos

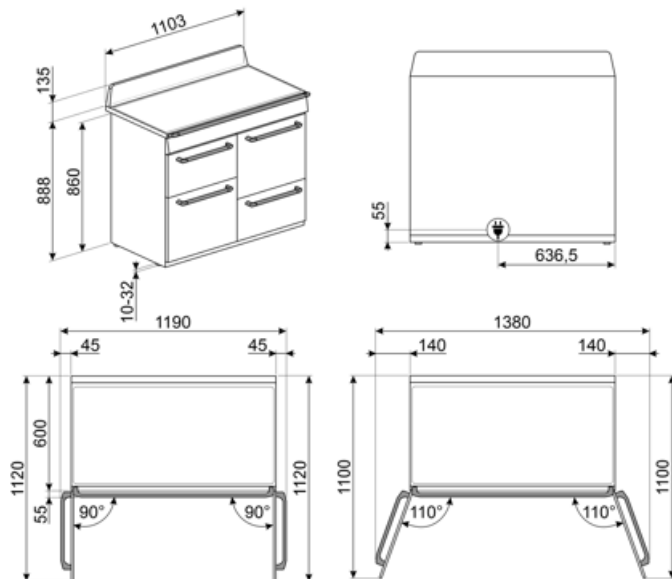

## Compatible Accessories

### AIRFRY

Air fryer rack AIRFRY . Ideal for recreating traditional frying in the oven, but with fewer calories and less fat. It allows you to cook quickly and simply dishes such as French fries, fried vegetables and fish, ensuring perfect browning and crispiness.



### BN620-1

Tabuleiro esmaltado, 20mm de profundidade



### BNP608T

Bandeja revestida de teflon, 8mm de profundidade, a ser colocada na grade



### GTP

\*\* Guias telescópicas parcialmente extraíveis (1 nível)\*\* Extração: 300 mm  
Material: Aço inoxidável AISI 430 polido



### KIT1TR41N

Painel anti-salpicos 110x75 cm adequado para fogões TR4110 Victoria, preto



### KITH4110

Kit extensão de altura (950 mm), adequado para fogões TR4110



### PALPZ

Pá para pizza com alça dobrável largura: 315mm comprimento : 325mm



### SFLK1

Bloqueio para crianças



### BBQ

Double sided plate BBQ. Suitable for recreating succulent and crispy dishes in the oven with the typical taste of grilled cooking. The ribbed side is particularly suitable for meats and cheeses. The smooth side for fish, seafood and vegetables.



### BN640

Tabuleiro esmaltado, 40mm de profundidade

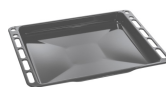

### GRILLPLATE

Placa de rede universal para indução, gás, cerâmica e fogões elétricos. Superfície antiaderente ideal para cozinhar carne, queijo e vegetais. Dimensões: 410 x 240 mm.



### GTT

\*\* Guias telescópicas totalmente extraíveis (1 nível)\*\* Extração: 433 mm  
Material: Aço inoxidável AISI 430 polido



### KIT600TR4110

Tira de cobertura para placa traseira, adequado para fogões Victoria TR4110



### KITP65TR41

Kit extensão de profundidade (650 mm), adequado para fogões TR4110



### SCRP

Placas de indução e de cerâmica e raspador teppanyaki



### SMOLD

Conjunto de 7 moldes de silicone para sorvetes, gelados, pralinés, cubos de gelo ou para porção de alimentos. Utilizável de -60°C a +230°C

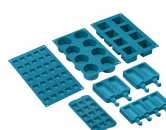

















### TPKPLATE

















Placa universal para placas de indução, gás, cerâmica e fogões elétricos. Superfície antiaderente ideal para cozinhar peixe, ovos e vegetais. Dimensões: 410 X 240 mm.

## Symbols glossary

	Bloqueio para crianças: alguns modelos estão equipados com um dispositivo para bloquear o programa/ciclo para que não possa ser acidentalmente alterado.		R: Desempenho de secagem do produto, medido de A++ a D/G, dependendo da família de produtos
	Instalação em coluna: Instalação em coluna		Controle dos botões
	Sistema de arrefecimento a ar: para garantir temperaturas de superfície seguras.		Descongela pelo tempo: com esta função, o tempo de descongelamento dos alimentos é determinado automaticamente.
	Portas envidraçadas triplas: Número de portas envidraçadas.		ECO-logic: opção permite-lhe restringir o limite de potência da poupança de energia real do aparelho.
	Interior esmaltado: O interior em esmalte de todos os fornos Smeg tem um revestimento antiácido especial que ajuda a manter o interior limpo, reduzindo a quantidade de gordura de cozimento aderente a ele.		Circogas: Em fornos a gás, o ventilador distribui o calor de forma rápida e uniforme por toda a cavidade do forno, evitando a transferência de sabor ao cozinhar vários pratos diferentes ao mesmo tempo. Em fornos elétricos, esta combinação completa o cozimento mais rapidamente de alimentos que estão prontos na superfície, mas que exigem mais cozimento no interior, sem mais escurecimento.
	Ventilador com elementos superiores e inferiores: Os elementos combinados com o ventilador visam fornecer calor mais uniforme, um método semelhante ao cozimento convencional, de modo que o pré-aquecimento é necessário. Mais adequado para itens que exigem métodos de cozimento lento.		Somente elementos superior e inferior: um método de cozimento tradicional mais adequado para itens individuais localizados no centro do forno. A parte superior do forno será sempre mais quente. Ideal para assados, bolos de frutas, pão, etc.
	Circulaire: A combinação do ventilador e do elemento circular em torno dele dá um método de cozimento de ar quente. Isso oferece muitos benefícios, incluindo nenhum pré-aquecimento se o tempo de cozimento for superior a 20 minutos, nenhuma transferência de sabor ao cozinhar alimentos diferentes ao mesmo tempo, menos energia e tempos de cozimento mais curtos. Bom para todos os tipos de alimentos.		ECO: A combinação da grelha, ventilador e elemento inferior é particularmente adequada para cozinhar pequenas quantidades de alimentos.
	Elemento de grelha O uso de grelha dá excelentes resultados ao cozinhar carne de porções médias e pequenas, especialmente quando combinada com uma rotisseria (sempre que possível). Também é ideal para cozinhar salsichas e bacon.		Elemento de grelha O uso de grelha dá excelentes resultados ao cozinhar carne de porções médias e pequenas, especialmente quando combinada com uma rotisseria (sempre que possível). Também é ideal para cozinhar salsichas e bacon.



-  Ventilador com elemento de grelha: O ventilador reduz o calor feroz da grelha, proporcionando um excelente método de grelhar vários alimentos, costeletas, bifés, salsichas, etc. dando o mesmo escurecimento e distribuição de calor, sem secar os alimentos. Os dois níveis superiores recomendados para uso e a parte inferior do forno podem ser usados para manter os itens quentes ao mesmo tempo, uma excelente facilidade ao cozinhar um café da manhã grelhado. Meia grelha (apenas porção central) é ideal para pequenas quantidades de alimentos.
-  Protecção contra o sobreaquecimento: O sistema de segurança que desliga automaticamente a placa em caso de sobreaquecimento da unidade de controle.
-  Toda a porta interna de vidro: Toda a porta interna de vidro, uma única superfície plana que é simples de manter limpa.
-  Luzes laterais: Duas luzes laterais opostas aumentam a visibilidade dentro do forno.
-  O compartimento do forno tem 4 níveis de cozimento diferentes.
-  Comando eletrônico. Permite manter a temperatura no interior do forno com a precisão de 2-3 ° C. Isso permite cozinhar refeições que são muito sensíveis a mudanças de temperatura, como por ex. bolos, suflês, pudins.
-  Limpeza a Vapor: uma função de limpeza simples que utiliza vapor para afrouxar os depósitos no compartimento do forno.
-  A capacidade indica a quantidade de espaço útil no compartimento do forno em litros.
-  Luz
-  Indução: O trabalho destas placas baseia-se no princípio da indução electromagnética. O calor é gerado diretamente na parte inferior da panela durante o seu contato com a placa.
-  O vidro interior da porta: pode ser removido com alguns movimentos rápidos para limpeza.
-  O compartimento do forno tem 2 níveis de cozimento diferentes.
-  Trilhos telescópicos: permitem puxar o prato e verificá-lo sem ter que removê-lo completamente do forno.
-  Grelha basculante: a grelha basculante pode ser facilmente desengatada para mover o elemento de aquecimento e limpar o tejadilho do aparelho em um simples passo.
-  A capacidade indica a quantidade de espaço útil no compartimento do forno em litros.

## Benefit (TT)

---

### **Induction hob**

Induction offers fast cooking and precise temperature control

Through the use of suitable cookware, induction is easy to use and maintain, safe and responsive.

### **Vapor Clean**

By inserting water into a recess at the bottom of the cavity, steam is generated, which softens the residue and facilitates its removal

By inserting water into a recess at the bottom of the cavity, steam is generated, which softens the residue and facilitates its removal.

### **Buttons control**

Easy and intuitive timer setting with a simple buttons

### **Drawer storage compartment**

More space thanks to the lower drawer compartment, ideal for storing accessories or cooking utensils

### **True-convection**

The best cooking performances guaranteed by ventilated circular flow

Multiple fans and heating elements guarantee the perfect aerodynamic heat flow, allowing homogeneous and quicker cooking inside the cavity.

### **Multilevel cooking**

Several cooking levels allow maximum flexibility of use

### **Multilevel halogen light**

Internal halogen lighting on different levels guarantees excellent visibility

### **Removable inner glass**

Internal door glasses are easily removable for complete cleaning

### **Tangential cooling**

New cooling system with tangential fan and airflow from the door to the splashback

### **Telescopic guides**

Easy extraction and safe insertion of trays into the oven thanks to telescopic guides

### **Isothermic Cavity**

The best cooking performance at the highest energy efficiency

**BBQ (optional accessory)**

Barbeque cooking directly in the oven with the double-sided grill (BBQ optional accessory)

**Pizza stone (optional accessory)**

Baking with refractory stone for soft and crispy pizza and yeast products (STONE optional accessory)

**Cold door**

During any function, the external door glass is cold, avoiding any risk of burns

**AirFry (AIRFRY optional accessory)**

Lighter and tastier food thanks to airfry basket (optional accessory)

**Adjustable height**

Cooker top flushed with the working area thanks to adjustable feet

**Single turbine**

The oven has a fan equipped with a circular heating element allowing cooking with rotating heat