

TR4110P1

Categorie fornuis	110x60 cm
N. of cavities with energy label	2
Cavity heat source	Elektriciteit
Type kookplaat	Gas
Type primaire oven	Thermogeventileerd
Type secundaire oven	Geventileerd
Reinigingssysteem primaire oven	Vapor Clean reiniging
EAN-code	8017709176655
Energie-efficiëntieklasse	A
Energie-efficiëntieklasse, tweede oven	A



Design



Design	Victoria	Bedieningsknoppen	Smeg Victoria
Afwerking bedieningspaneel	Gekleurd plaatstaal	Kleur bedieningsknoppen	Inox
Design	Victoria	Aantal bedieningsknoppen	12
Logo	assembled 50's	Kleur serigrafie	Zwart
Kleur	Crème	Display	Elektronisch 5 toetsen
Positie logo	Upstand	Deur	Met kader
Afwerking	Glanzend	Type glas	Zwart
Upstand	Ja	Handgreep	Smeg Victoria
Kleur kookplaat	Black enamel	Kleur handgreep	Geborsteld inox
Type pottendragers	Gietijzeren pottendragers	Opberg ruimte	Opbergvak met lade
Bediening	Bedieningsknoppen	Plint	Antraciet

Programma's / Functies

Aantal kookfuncties	5
Traditionele bereidingsfuncties	



Statisch



Geventileerd



Circulatie (ventilator + circulaire)



ECO



Geventileerde onderwarmte

Overige functies

 Ontdooien

Reinigingsfuncties

 Vapor Clean reiniging

Programma's / Functies secundaire oven

Aantal kookfuncties 5

Traditionele bereidingsfuncties, 2e oven

 Statisch

 Geventileerd



Circulatie (ventilator + circulaire)

 ECO

 Geventileerde onderwarmte

Vapor Clean reiniging



Reinigingsfunctie 2e oven

Overige functies 2e oven

 Ontdooien

Programma's / Functies derde oven

Aantal functies derde oven

1

Licht



Grote vlakgrill



Technische specificaties kookplaat



Totaal aantal kookzones 7

Linksvoor - Gas - 2URP (dual) - 4.20 kW

Linksvoor - Gas - AUX - 1.00 kW

Linksachter - Gas - RP - 2.90 kW

Middenvoor - Gas - RP - 2.90 kW

Middenachter - Gas - AUX - 1.00 kW

Rechtsvoor - Gas - SRD - 1.80 kW

Rechtsachter - Gas - SRD - 1.80 kW

Type gasbranders Standaard

Thermobeveiliging

Ja

Automatische vonkontsteking Ja

Branderdeksels

Mat zwart geëmailleerd

Technische specificaties primaire oven



Aantal lampen	1	Aantal ruiten ovendeur	3
Netto volume 1e oven	61 l	Aantal thermo-reflecterende ruiten	1
Bruto volume, oven 1	70 l	Veiligheidsthermostaat	Ja
Materiaal ovenruimte	Ever Clean emaille	Koelsysteem	Mantelkoeling
Aantal kookniveaus	4	Afmetingen bruikbare interne ovenruimte (hxbxd)	316x460x412 mm
Type ovenrekken	Metalen zijsteunen	Temperatuurregeling	Elektro-mechanisch
Type licht	Halogeen	Onderwarmte - vermogen	1200 W
Vermogen lamp	40 W	Bovenwarmte - vermogen	1000 W
Opties bereidingstijdprogrammering	Begin en eind	Grill - vermogen	1700 W
Opening deur	Side opening	Grote vlakgrill - vermogen	2700 W
Uitneembare ovendeur	Ja	Circulatie - vermogen	2700 W
Volledig glazen binnendeur	Ja	Grill type	Elektrisch
Uitneembaar glas binnendeur	Ja		

Opties primaire oven

Timer	Ja	Minimum temperatuur	50 °C
Geluidssignaal einde kooktijd	Ja	Maximum temperatuur	260 °C

Technische specificaties secundaire oven



Netto volume 2e oven	61 l	Aantal ruiten ovendeur	3
Bruto volume, oven 2	70 l	Aantal thermo-reflecterende ruiten	1
Materiaal ovenruimte	Ever Clean emaille	Veiligheidsthermostaat	Ja
Aantal kookniveaus	4	Koelsysteem	Mantelkoeling
Type ovenrekken	Metalen zijsteunen	Afmetingen bruikbare interne ovenruimte (hxbxd)	316x444x425 mm
Aantal lampen	1	Temperatuurregeling	Elektro-mechanisch
Type lamp	Halogeen	Onderwarmte - vermogen	1200 W
Vermogen lamp	40 W	Bovenwarmte - vermogen	1000 W
Opening deur	Side opening	Grill - vermogen	1700 W
Uitneembare ovendeur	Ja	Grote vlakgrill - vermogen	2700 W
Volledig glazen binnendeur	Ja	Type grill	Elektrisch
Uitneembaar glas binnendeur	Ja		

Kantelbare grill Ja

Opties secundaire oven

Minimum temperatuur 50 °C

Maximum temperatuur 260 °C

Technische specificaties derde oven



Netto volume, 3e oven 36 l
Bruto volume, oven 3 41 l
Materiaal ovenruimte Ever Clean emaille
Aantal kookniveaus 2
Type ovenrekken Metalen zijsteunen
Aantal lampen 1
Type lamp Gloeilamp
Vermogen lamp 25 W
Opening deur Neerwaarts
Uitneembare ovendeur Ja
Volledig glazen binnendeur Ja

Uitneembaar glas binnendeur Ja
Aantal ruiten ovendeur 3
Aantal thermo-reflecterende ruiten 1
Veiligheidsthermostaat Ja
Koelsysteem Mantelkoeling
Afmetingen bruikbare interne ovenruimte (hxbxd) 169x440x443 mm
Temperatuurregeling Elektro-mechanisch
Grote vlakgrill - vermogen 2700 W
Type grill Elektrisch
Kantelbare grill Ja

Opties derde oven

Minimum temperatuur 50 °C

Maximum temperatuur 260 °C

Meegeleverde accessoires primaire oven en kookplaat



Gietijzeren wokring 1
Ovenrooster met stop 2
Bakplaat (40 mm) 1
Inzetrooster 1
Telescopische geleiders, gedeeltelijk uitschuifbaar 1

Meegeleverde accessoires secundaire oven



Ovenrooster met stop 2
Bakplaat (40 mm) 1
Inzetrooster 1
Telescopische geleiders, gedeeltelijk uitschuifbaar 1

Meegeleverde accessoires derde oven

Ovenrooster met stop 1

Bakplaat (40 mm) 1

Elektrische aansluiting

Nominale aansluitwaarde	8400 W	Testkabel	Ja
Stroom	37 A	Type stroomkabel	Double and Three Phase
Spanning	220-240 V	Frequentie	50/60 Hz
Spanning 2 (V)	380-415 V	Connection box	5 polig
Electric cable	Installed, Single phase	Stekker	Nee

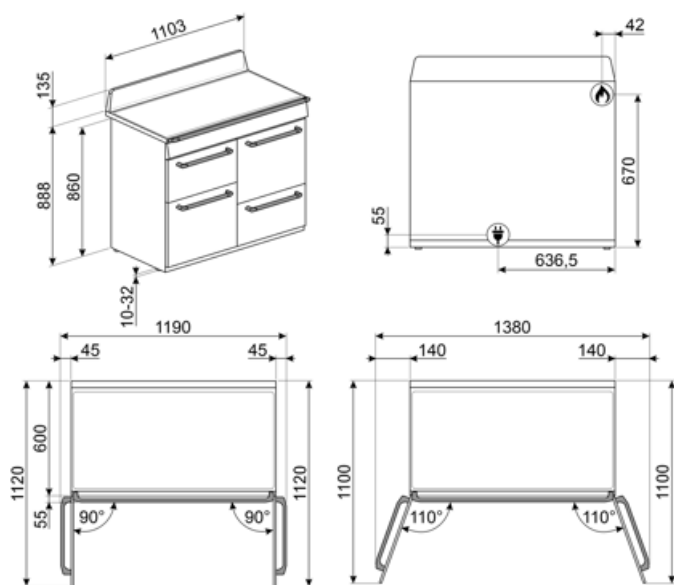

Compatible Accessories

AIRFRY



BBQ

Dubbelzijdig



BN640

Enamelled tray suitable for 45cm and 60cm ovens. Depth 540 mm. Perfect for cooking and roasting meat and fish in sauces. Also ideal for experimenting with lighter and crunchy side dishes



GTP

Partially extractable telescopic guides (1 level), suitable for traditional ovens. Made in stainless steel, they guarantee stability and facilitate the smooth extraction of the trays.



KIT1TR41N

Splashback black, 110cm ,suitable for TR4110 Victoria cookers



KITH4110

Height extension kit (950mm), black, suitable for TR4110 cookers (945-965mm)



PALPZ

Pizzapallet inox met ploibaar handvat, 315x325 mm



SMOLD

Set van 7 siliconen vormen voor ijsjes, pralines, ijsblokjes of porties. -60°C tot 230°C.

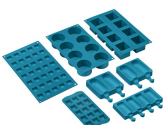

AIRFRY2

Air fryer tray. Ideal for recreating traditional frying in the oven, but with fewer calories and less fat. It allows you to cook quickly and simply dishes such as French fries, fried vegetables and fish, ensuring perfect browning and crispiness.



BN620-1

Enamelled tray suitable for 45 cm and 60 cm ovens. Depth 20 mm. Perfect for a wide range of savoury and sweet baking.



BNP608T

Teflon bakplaat, 8mm diep



GTT

Volledig uitschuifbare telescopische rails (1 niveau) voor traditionele ovens (SF-).



KIT600TR4110

Cover strip for hob back side, suitable for TR4110 Victoria cookers



KITP65TR41

Depth extension kit (650 mm), black, suitable for TR4110 cookers



SFLK1

Child lock





























WOKGHU

Gietijzeren wok steun



Symbols glossary

 <p>Heavy duty cast iron pan stands: for maximum stability and strength.</p>	 <p>Energy efficiency class A</p>
 <p>Installation in column: Installation in column.</p>	 <p>Air cooling system: to ensure a safe surface temperatures.</p>
 <p>With the switch on this symbol, no heating is possible even if the thermostat is turned.</p>	 <p>Triple glazed doors: Number of glazed doors.</p>
 <p>Ever Clean Enamel: Ever Clean enamel is applied electrostatically, corner to corner and edge to edge to prevent cracking or cracks over time. It is a particular pyrolytic enamel, resistant to acids which, in addition to being pleasantly bright, promotes greater cleaning of the oven walls, thanks to its lower porosity. It is baked at over 850 °C and slowly polymerized at a scientifically determined rate to ensure uniform depth and strength. Ever Clean enamel creates an impeccable finish both on the inside of the oven and on the trays, making the surfaces of the oven incredibly easy to maintain over time as it reduces the adhesion of fat during cooking.</p>	 <p>Circogas: In gasovens verdeelt de ventilator de warmte snel en gelijkmatig over de ovenruimte, waardoor smaakoverdracht wordt vermeden bij het tegelijkertijd bereiden van een aantal verschillende gerechten. In elektrische ovens voltooit deze combinatie het koken van voedsel dat aan de oppervlakte klaar is, maar dat van binnen meer moet worden gekookt, zonder verder bruin te worden.</p>
 <p>Ventilator met bovenste en onderste elementen: De elementen in combinatie met de ventilator zijn bedoeld om een meer gelijkmatige warmte te bieden, een methode die vergelijkbaar is met conventioneel koken, dus voorverwarmen is vereist. Het meest geschikt voor items die langzaam koken vereisen.</p>	 <p>Alleen boven- en onder element: een traditionele kookmethode die het meest geschikt is voor losse items in het midden van de oven. de bovenkant van de oven zal altijd het heetst zijn. Ideaal voor gebraden vlees, fruitcake, brood etc.</p>
 <p>Circulaire: De combinatie van de ventilator en het ronde element eromheen zorgt voor een hete lucht kookmethode. Dit biedt vele voordelen, waaronder geen voorverwarmen als de kooktijd meer dan 20 minuten bedraagt, geen smaakoverdracht bij het gelijktijdig bereiden van verschillende soorten voedsel, minder energie en kortere kooktijden. Geschikt voor alle soorten voedsel.</p>	 <p>De combinatie van de grill, de ventilator en onderwarmte is interessant voor het bereiden van kleine hoeveelheden.</p>
 <p>Grill element: Using of grill gives excellent results when cooking meat of medium and small portions, especially when combined with a rotisserie (where possible). Also ideal for cooking sausages and bacon.</p>	 <p>Light</p>
 <p>All glass inner door: All glass inner door, a single flat surface which is simple to keep clean.</p>	 <p>The inner door glass: can be removed with a few quick movements for cleaning.</p>
 <p>Side lights: Two opposing side lights increase visibility inside the oven.</p>	 <p>The oven cavity has 2 different cooking levels.</p>

-
-  The oven cavity has 4 different cooking levels.
 -  Electronic control: Allows you to maintain temperature inside the oven with the precision 2-3 ° C. This enables to cook meals that are very sensitive to temperature changes, such as cakes, souffles, puddings.
 -  Ultra rapid burners: Powerful ultra rapid burners offer up to 5kw of power.
 -  The capacity indicates the amount of usable space in the oven cavity in litres.
 -  Knobs control
 -  Telescopic rails: allow you to pull out the dish and check it without having to remove it from the oven entirely.
 -  Tilting grill: the tilting grill can be easily unhooked to move the heating element and clean the roof of the appliance in one simple step.
 -  Vapor Clean: a simple cleaning function using steam to loosen deposits in the oven cavity.
 -  The capacity indicates the amount of usable space in the oven cavity in litres.

Benefit (TT)

Gas hob

Gas provides permanent control of the heat source and the temperature change is immediate

Equipped with a thermocouple, the gas supply is cut off if the flame is extinguished for greater safety.

Vapor Clean

By inserting water into a recess at the bottom of the cavity, steam is generated, which softens the residue and facilitates its removal

By inserting water into a recess at the bottom of the cavity, steam is generated, which softens the residue and facilitates its removal.

Buttons control

Easy and intuitive timer setting with a simple buttons

Drawer storage compartment

More space thanks to the lower drawer compartment, ideal for storing accessories or cooking utensils

True-convection

The best cooking performances guaranteed by ventilated circular flow

Multiple fans and heating elements guarantee the perfect aerodynamic heat flow, allowing homogeneous and quicker cooking inside the cavity.

Multilevel cooking

Several cooking levels allow maximum flexibility of use

Multilevel halogen light

Internal halogen lighting on different levels guarantees excellent visibility

Removable inner glass

Internal door glasses are easily removable for complete cleaning

Tangential cooling

New cooling system with tangential fan and airflow from the door to the splashback

Telescopic guides

Easy extraction and safe insertion of trays into the oven thanks to telescopic guides

Adjustable height

Cooker top flushed with the working area thanks to adjustable feet

Isothermic Cavity

The best cooking performance at the highest energy efficiency

BBQ (optional accessory)

Barbecue cooking directly in the oven with the double-sided grill (BBQ optional accessory)

Pizza stone (optional accessory)

Baking with refractory stone for soft and crispy pizza and yeast products (STONE optional accessory)

Cold door

During any function, the external door glass is cold, avoiding any risk of burns

AirFry (AIRFRY optional accessory)

Lighter and tastier food thanks to airfry basket (optional accessory)